

Living With Earthquakes In The Pacific  
Northwest



Living With  
Earthquakes In The  
Pacific Northwest

*A Survivor's Guide*

ROBERT S. YEATS

OREGON STATE UNIVERSITY  
CORVALLIS, OR



*Living With Earthquakes In The Pacific Northwest* by Robert S. Yeats is licensed under a [Creative Commons Attribution-NonCommercial 4.0 International License](https://creativecommons.org/licenses/by-nc/4.0/), except where otherwise noted.

Download for free at <https://open.oregonstate.edu/earthquakes>

Publication and on-going maintenance of this textbook is possible due to grant support from [Oregon State University Ecampus](https://www.oregonstate.edu/).

[Suggest a correction](#)

# Contents

|  |     |
|--|-----|
| <a href="#">Cover</a>  | ix  |
| <a href="#">Copyright Page</a>   | x   |
| <a href="#">Preface to the Second Edition</a>  | xii |
| <a href="#">Preface to the Third Edition</a>   | xix |
| <br>   |     |
| <a href="#">Part I. Part I: Introduction</a>   |     |
| <br>   |     |
| <a href="#">Part II. Part II: Tectonic Plates, Geologic Time, and Earthquakes</a>      |     |
| <br>   |     |
| 1. <a href="#">A Concept of Time</a>   | 11  |
| 2. <a href="#">Plate Tectonics</a>   | 25  |
| 3. <a href="#">Earthquake Basics</a>   | 53  |
| 4. <a href="#">Cascadia Subduction Zone</a>  | 122 |
| 5. <a href="#">Earthquakes in the Juan de Fuca Plate</a>                               | 195 |
| 6. <a href="#">Earthquakes in the Crust: Closer to Home</a>                            | 229 |
| 7. <a href="#">Memories of the Future: The Uncertain Art of Earthquake Forecasting</a> | 332 |

Part III. Part III: Shaky Ground and Big  
Waves

- |  |     |
|--|-----|
| 8. <a href="#">Solid Rock and Bowls of Jello</a> | 403 |
| 9. <a href="#">Tsunami!</a>                      | 455 |

Part IV. Part IV: Prevention and  
Countermeasures

- |   |     |
|---|-----|
| 10. <a href="#">Earthquake Insurance: Betting Against Earthquakes</a> | 511 |
| 11. <a href="#">Is Your Home Ready for an Earthquake?</a>             | 551 |
| 12. <a href="#">Earthquake Design of Large Structures</a>             | 589 |
| 13. <a href="#">The Federal Government and Earthquakes</a>            | 626 |
| 14. <a href="#">The Role of State and Local Government</a>            | 679 |
| 15. <a href="#">Preparing for the Next Earthquake</a>                 | 738 |
| 16. <a href="#">An Uncertain Appointment with a Restless Earth</a>    | 762 |

[Appendix A: Significant Historical Earthquakes in the Pacific Northwest](#) 783

[Appendix B: Glossary](#) 799

[Appendix C: Credits](#) 800

[Appendix D: Sources of Information and Websites](#) 812

|   |     |
|---|-----|
| <a href="#"><u>About the Author</u></a>         | 819 |
| <a href="#"><u>Index</u></a>                    | 820 |
| <a href="#"><u>Creative Commons License</u></a> | 845 |
| <a href="#"><u>Recommended Citations</u></a>    | 846 |
| <a href="#"><u>Versioning</u></a>               | 849 |





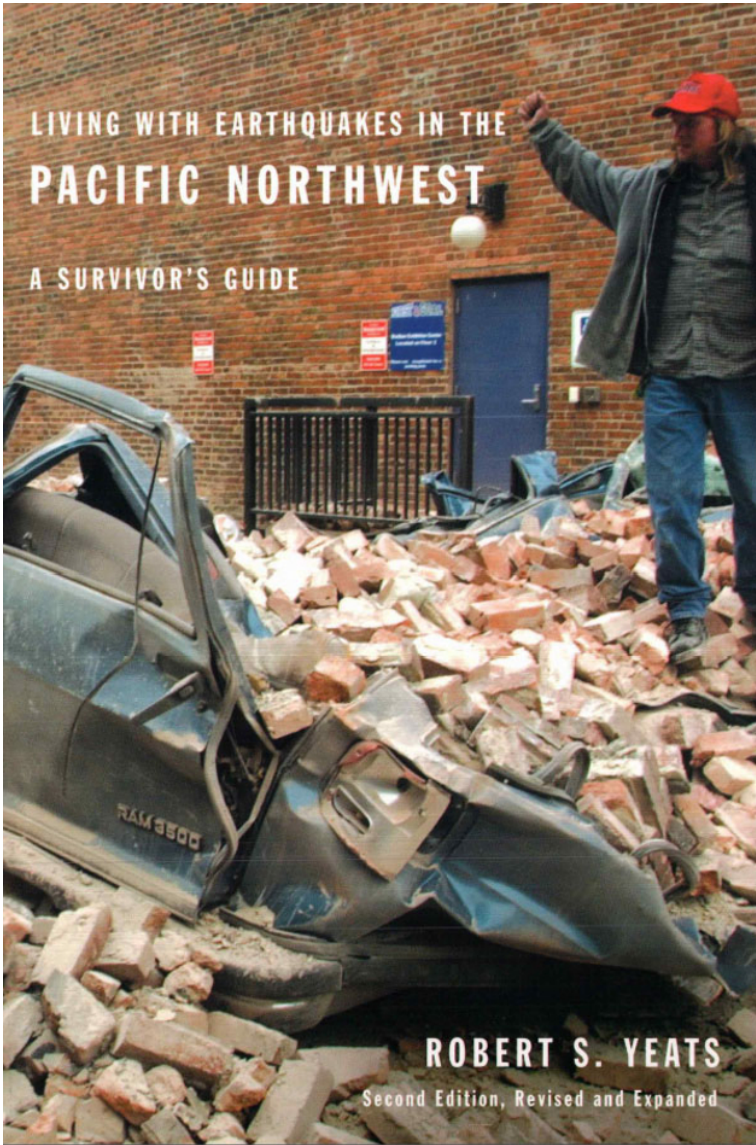



**Oregon State University Press**

121 The Valley Library

Corvallis OR 97331-4501

541-737-3166 • fax 541-737-3170

[www.osupress.oregonstate.edu](http://www.osupress.oregonstate.edu)

*“And ye shall flee to the valley of the mountains;  
for the valley of the mountains shall reach unto  
Azal: yea, ye shall flee, like as ye fled from before  
the earthquake in the days of Uzziah king of  
Judah.”*

Book of Zechariah 14:4-5,  
issuing the world’s first earthquake forecast.  
The new earthquake did not arrive until 31 B.C.,  
about five hundred years later.



This work is licensed under a [Creative Commons Attribution-NonCommercial-ShareAlike 4.0 International License](https://creativecommons.org/licenses/by-nc-sa/4.0/).

# Preface to the Second Edition

At first, it was simply the excitement of a scientific discovery: that the Pacific Northwest, where I live, was wracked by great earthquakes in its recent past. During the 1980s, the U.S. Geological Survey held meetings and workshops to debate the possibility of catastrophic earthquakes beneath the magnificent mountains and verdant valleys of the land of Lewis and Clark. Then we held our own meeting in Oregon, and I became a convert.

But after a while, I began to wonder whether it was more important to discuss earthquakes with my scientific colleagues or, instead, with my wife, my next-door neighbor, or the state legislature. This question solved itself when, following the recognition of a looming earthquake threat, the earthquakes themselves started to arrive: Loma Prieta, California, in 1989, two Oregon earthquakes in 1993, and Northridge, California, in 1994. I found myself on the Rolodexes of media reporters, and I became a media resource (make that “talking head”), usually before I knew the details of the earthquake I was asked to explain.

In some respects, telling my Northwest neighbors that we have an earthquake problem has been like telling them about carpenter ants in their basement or

about high blood pressure and high cholesterol as a result of high living. The reaction was, “Yes, I know, but I don’t want to think about it right now, let alone do anything about it.” But the sheer size of the earthquake problem dwarfs other concerns we face: thousands of fatalities and tens of billions of dollars in damage. Suddenly, earthquake science stopped being fun, and as a scientist, I began to feel like the watchman on the castle walls warning about barbarians at the gate, begging people to take me seriously.

Part of my frustration was that, despite the scientific discoveries and despite the television images of earthquake damage, nobody seemed to remember anything. I could give a talk to a civic club in 1995, two years after the two Oregon earthquakes, and find out in the question and answer period that most of my listeners were surprised to learn that they ought to be taking some steps to protect themselves against earthquakes, just as they would against fire. People on the street interviewed on television in 2003 after a small earthquake in north Portland were clueless about earthquakes.

A solution to my problem came at the university where I teach. Oregon State University had recently adopted a baccalaureate core curriculum that includes courses that synthesize and integrate student learning at the advanced undergraduate level. One of the components of the new curriculum is a course relating the discoveries of science to their impact on technology and on society (Yeats, 2003).

In 1995, I offered to teach a course that told the story of the scientific recognition of the earthquake problem in the Northwest and of how society has responded to it in terms of legislation, building codes, insurance premiums, elementary school curricula, and individual and community preparedness. The course was first taught in winter term, 1997, to a large class on campus and was also televised on three cable channels in Oregon. The class notes written for this course served as the nucleus of this book, a text for future classes. In 1998, the course was offered again on campus and on the three cable channels as well as four outlying classrooms via closed-circuit television. It has been taught every year since by Andrew Meigs or Bob Dziak.

Students signed up from across the campus community. I required a five-page term paper on a topic related to earthquakes. Although the prospect of reading nearly two hundred term papers was daunting, it turned out to be the most gratifying part of the course. Students wrote lesson plans for third graders, retrofit plans for their parents' houses, designs for earthquake-resistant bridges, community response strategies, and potential escape routes from an impending tsunami, even the feasibility of surfing a tsunami! It turns out that surfing a tsunami can't be done, but surfing the Internet allowed students, even in distant learning sites far from a university library, to get up-to-the-minute information, so that in some cases, the student learned about new developments before I did. I was reminded again of the awesome creative

potential of motivated undergraduates, some only a few years out of high school, others returning to school in mid-life. Some of these term papers enriched my own experience and knowledge and thereby enriched this book.

Although the book was written for the students in these classes, it serves a larger community as well: families concerned about earthquake hazards in their decisions about where to live, legislators presented with bills to expand (or reduce) earthquake protection, insurance actuaries wondering what premiums to charge for earthquake insurance, high school principals and teachers trying to figure out why they are told to conduct earthquake drills in schools, local officials considering stricter ordinances to regulate growth while avoiding lawsuits, and the growing number of people involved professionally in emergency preparedness. With better knowledge about what is (and is not) possible, people can make more informed decisions.

Writing the book led me into subject areas in which I was woefully uninformed, and here I had a lot of help from others in seeking out information, in guest lectures to my class, and in reviewing chapters. My thanks go to Clarence Allen of Caltech, Derek Booth, Ken Creager, Bob Crosson, Ruth Ludwin, Bill Steele, and Kathy Troost of the University of Washington, Jeff Fletcher of Northern Pacific Insurance Co., Richard J. Roth of the California Department of Insurance, Joan Scofield of the Washington State Insurance

Commissioner's Office, Chris Jonientz-Trisler and Mark Stevens of FEMA, Brian Atwater, Pat McCrory, Alan Nelson, Steve Obermeier, Bob Schuster, Brian Sherrod, and Craig Weaver of the U.S. Geological Survey, Pat Pringle, Karl Wegmann, and Tim Walsh of the Washington Division of Geology and Earth Resources, Don Hull, Ian Madin, George Priest, and Yumei Wang of the Oregon Department of Geology and Mineral Industries, Mark Darienzo of Oregon Emergency Management, John Cassidy of the Pacific Geoscience Centre, John Clague of Simon Fraser University, Kenji Satake of the University of Tokyo, Scott Ashford, Chris Goldfinger, Vern Kulm, Bob Lillie, Lisa McNeill, Andrew Meigs, Steve Dickenson, and Tom Miller of Oregon State University, Pat Corcoran of OSU Extension, Ray Weldon of the University of Oregon, Scott Burns and Ron Cease of Portland State University, Lori Dengler of Humboldt State University, Mark Benthien and John McRaney of the Southern California Earthquake Center, Jim Davis and Bob Sydnor of the California Geological Survey, Diane Murbach of the City of San Diego, Eldon Gath of Earth Consultants International, Jim Swinyard of Benton County, Oregon, Diane Merton of the Benton County Emergency Management Council, Roger Faris of the Finney Neighborhood Center in Seattle, Hal Mofjeld and Bob Dziak of the National Oceanic and Atmospheric Administration, Bob Freitag of the Cascadia Regional Earthquake Workgroup (CREW), and David Middleton of the New Zealand Earthquake Commission. I learned much from the delegates to the



Western States Seismic Policy Advisory Council meeting in Victoria, B.C. in October, 1997 and in Portland, Oregon, in September, 2003, and from a conference on Cascadia sponsored by the Geological Society of America in Seaside, Oregon.

Illustrations make a book. I received original photographs and drawings from Tanya Atwater (of the University of California, Santa Barbara), Chris Goldfinger of OSU, Meghan Miller, (then of Central Washington University), Sarah Nathe (then of the California Office of Emergency Services), Gordon Jacoby (of Columbia University). Robert Kamphaus (of the National Oceanic and Atmospheric Administration), Steve Obermeier, Rick Minor (of Heritage Research Associates), Kenji Satake, the late Karl Steinbrugge, Bill Steele, Tim Walsh, Pat Pringle, Karl Wegmann, David Oppenheimer, Brian Atwater, Alan Nelson, and David Wald of the U.S. Geological Survey, and Pat Williams (of Lawrence Berkeley Laboratory). Original figures for this edition were drafted by Kristi Weber. The color slide collection of the National Oceanic and Atmospheric Administration, available from the National Geophysical Data Center, was the source of several photographs. Jack Ohman allowed me to use his perceptive cartoon that appeared in the Oregonian after the Scotts Mills earthquake in 1993, and Morika Tsujimura and Chris Scholz permitted the use of their cartoon in Chapter 7.

The second edition got its start as a result of my invitation by Ken Creager of the Department of Earth and Space Sciences of the University of Washington

to assist him in an earthquake outreach class in the spring of 2003. This gave me the opportunity to talk to the large community of earthquake professionals in the Seattle area and to consider the impact of the Nisqually Earthquake of 2001, which struck after the publication of the first edition and tested the earthquake preparedness of the Seattle, Tacoma, and Olympia metropolitan areas.

Thorough and constructive edits of the entire first-edition manuscript were provided by the late George Moore of Oregon State University and my wife, Angela, who pointed out my scientific jargon that got in the way of communicating to a lay readership. Jo Alexander of the OSU Press edited the final manuscript and carried both editions through to completion.

Ultimately, the success of this book will be measured after the next large earthquake, when we ask ourselves, “Were we ready?”

Robert S. Yeats  
Corvallis, Oregon

---

### *Suggestion for Further Reading*

Yeats, R. S., 2003. Seismology and society: A course in why it all matters. *Seismological Research Letters*, v. 74, p. 625-27.

# Preface to the Third Edition

I was asked by Tom Booth, Associate Director of the Oregon State University Press, if I was interested in publishing an online version of *Living with Earthquakes in the Pacific Northwest*, to be made available to students and the general public without charge. The two print editions, published in 1998 and 2004, have been used in classes as part of OSU's Baccalaureate Core Curriculum, showing how science and technology have contributed to our society. The book has also been a source of information on how people of the Northwest should prepare themselves for the next, inevitable earthquake.

The idea of a free online book appealed to me, because students would not have to worry about selling the book back to the bookstore but could keep it as a resource if they remained in the Northwest. An online edition allows me to include color photographs and maps, which I could not do in the earlier editions except for the book cover. In addition, this third edition includes earthquake-related animations graciously supplied by Jenda Johnson, an OSU graduate in geology, and Dr. Robert Butler of the University of Portland. These videos have further references to videos by the Incorporated Research Institutions in Seismology

(IRIS), which have been made in cooperation with Jenda Johnson and Bob Butler. You are urged to view these yourself and persuade your friends and family to view them also, because the videos stress the need for preparedness against the next catastrophic Cascadia Subduction Zone earthquake.

The study of the Cascadia Subduction Zone continues to advance, from its first recognition as a seismic hazard in the 1980s to the development by Chris Goldfinger of a paleoseismic earthquake history over the past 10,000 years, the longest subduction-zone record on Earth. The magnitude 9 earthquake and accompanying tsunami that we are expecting in the Northwest happened first in northeast Japan on March 11, 2011; the effects that were indicated based on geological evidence, such as sudden coseismic subsidence of the coast, were actually observed and photographed in Japan. This gave us new information on our own Cascadia earthquake, still in the not-too-distant future.

The Japanese are the best prepared society on Earth when it comes to earthquakes, but they underestimated the size of the accompanying tsunami, which resulted in the deaths of nearly sixteen thousand people in 2011. Let's hope this does not happen to us.

Another development was an assessment of the cost of doing nothing, or of taking only token steps toward earthquake preparedness. Scientists still are unable to predict the time, place, and magnitude of the next damaging earthquake, and this has given society and

its decision-makers an excuse not to spend the money that is needed to prepare for the next one. Some legislators, particularly those representing citizens living on the coast, were concerned about this and wanted to know what the cost would be of not taking steps in advance. Both Oregon and Washington authorized resilience surveys in which the effects of a large earthquake were calculated by working groups of structural engineers, earth scientists, planners, and general citizens. These working groups found that many buildings, including schools, hospitals, and command centers for local government, are likely to collapse during the next earthquake, with the loss of thousands of lives—this would be the greatest catastrophe in the two centuries that the Northwest has been under settlement by people of European descent. Their findings are summarized in a report by the Cascadia Regional Earthquake Workgroup (CREW). The legislature has authorized a continuation of their surveys under the leadership of Scott Ashford, Dean of Engineering at OSU.

In addition to losses incurred during such an earthquake, including the destruction of businesses and critical facilities like hospitals, the resilience surveys show that western Oregon and Washington would take many months to recover to pre-earthquake conditions. Businesses, particularly those on the coast, would be forced to relocate, taking jobs and the tax base with them. The comparison would be with New Orleans after Hurricane Katrina, devastated after the

failure of levees along the Mississippi River and flooding of populated areas such as the Ninth Ward. Years after Hurricane Katrina, the population and economy of New Orleans still have not recovered. This is likely to be the situation in the Northwest, especially along the coast, except on a much larger scale. Recovery in the affected states (and the Canadian province of British Columbia) would require the expenditure of large amounts of money over a period of many years. How will this be paid for?

My objective is for you to use this book as a guide to preparation for the next earthquake, a far more important goal than just taking the baccalaureate core course. The information in this book should provide the arguments you need to become an advocate for major strengthening of our society against the coming earthquake. The future of the Northwest will depend on a society that has prepared itself to survive the earthquake. The book is being published online, which will permit us to update it as new information becomes available.

On behalf of the people responsible for preparing the Northwest for the next subduction-zone earthquake, I express my gratitude to the Oregon State University Press for selecting this book to be published in an online edition that will be available free to students taking our earthquake class, and especially to the larger community of residents of the Northwest and British Columbia who will be able to use this book in preparing

our region against the arrival of the inevitable catastrophic subduction-zone earthquake.





## PART I

# PART I:

# INTRODUCTION

We are not used to the idea of earthquakes near my home in the Pacific Northwest. Earthquakes are a threat to California, Japan, and Alaska, but surely not to Seattle, Spokane, Portland, and Vancouver. That was certainly my own view in 1977, when I moved to Corvallis, Oregon, even though I had been studying earthquakes for many years—in California, of course. My neighbor said, “Earthquakes? Bob, you gotta be kidding!”

On the other hand, the Pacific Northwest is flanked by a huge offshore active fault more than seven hundred miles long at the base of the continental slope: the *Cascadia Subduction Zone*. Subduction zones are where masses of crust collide, and a block of oceanic crust is forced down deep into the Earth’s interior. Subduction zones around the Earth produce most of the world’s great earthquakes. Unlike most of the other subduction zones, the Cascadia Subduction Zone has not suffered an earthquake since local written records have been kept. Modern seismographs show very little microearthquake activity on this subduction zone. I assumed, as did most of my scientific colleagues, that subduction in the Pacific Northwest is nonviolent, and

that the oceanic crust somehow eases beneath the major cities of the Northwest without building up strain that would be released by earthquakes.

But in 1983, I heard a presentation by John Adams, a young New Zealand geologist transplanted to the Geological Survey of Canada. Adams stated that there *might* be an earthquake hazard in the Pacific Northwest. He had learned that a little-known federal agency, the National Geodetic Survey, routinely re-levels U.S. highway survey markers, and he decided to compare old level lines with more recent ones. Changes in the relative elevation of survey monuments and benchmarks along Pacific Northwest highways could provide evidence of the slow buildup of tectonic strain, ultimately leading to an earthquake.

If there were no warping of the Earth's crust, re-leveling highway markers would be a pretty boring job. Each survey would be exactly like the previous one. But the re-leveling done by the National Geodetic Survey in the Pacific Northwest was not the same between surveys. It showed an ominous change. The highways crossing the Coast Range are being tilted slowly toward the Willamette Valley in Oregon and Puget Sound in Washington. Could this mean an increase of strain in the Earth's crust, like a diving board being bent, and possibly a future rupture and earthquake?

As a student of natural disasters, I worry about needlessly alarming the public. What would be the reaction of people in major cities like Seattle, Tacoma, and Portland to such bad news? "Cool it, John," I said.

Good scientist that he is, Adams ignored my advice and published his results anyway. What was the result? Nothing! For the average person, the idea was too far-fetched. The media did not pick up on the story, and Adams' research paper was read only by other scientists. I breathed a sigh of relief, but I also began to worry that my early assumption of a slippery subduction zone might be wrong. So I waited for scientific confirmation from other sources.

Evidence was not long in coming. In 1984, Tom Heaton and Hiroo Kanamori, two seismologists from the California Institute of Technology (Caltech), published a comparison of the Cascadia Subduction Zone with others around the world. They knew that Cascadia was unusually quiet, but otherwise the geologic setting was the same as that of other subduction zones that had experienced catastrophic earthquakes, like those off the coasts of Chile and Alaska. The oceanic crust in the Cascadia Subduction Zone is relatively young, which means that it has cooled from the molten state only a few million years ago (a short time for a geologist). Because it is hotter than other oceanic crust, it is also lighter and more buoyant, meaning that it is not likely to slide smoothly beneath the continent. (The comparison I use is that of trying to stuff an air mattress beneath a floating raft.) Other subduction zones similar to Cascadia have been visited in this century by earthquakes of magnitudes greater than 8. Could it be that the reason for the lack of seismic activity here is that this subduction zone is

*completely locked?* Maybe the time during which records have been kept, less than two hundred years, is too short for us to conclude that the Pacific Northwest is not earthquake country.

At the same time, Jim Savage and his colleagues at the U.S. Geological Survey (USGS) were re-surveying geodetic benchmarks and finding evidence of horizontal contraction of the crust of western Washington, which could be explained as a response to the eastward driving of the oceanic plate beneath the continent, further evidence that the Cascadia Subduction Zone is locked but building up strain.

Two years after Heaton and Kanamori published their model of a locked subduction zone, Brian Atwater of the USGS in Seattle was paddling his kayak up the Niawiakum Estuary of Willapa Bay, in southwestern Washington. The purpose of his trip was to examine soft sediment along the banks of the estuary, which he was able to observe only at very low tide. This young sediment, only a few hundred years old, might contain evidence to support or refute the ideas that were being advanced about earthquakes.

There Atwater made an astonishing observation. Just beneath the marsh grass is gray clay containing microscopic marine fossils, evidence that it had once been deposited beneath the surface of the sea. Below the gray clay is a soil and peat layer from an older marsh, together with dead cedar stumps from an ancient forest. These stumps had been covered by the marine gray clay, in which the present marsh grass had

grown. Why are the fossil forest and the fossil marsh overlain by clay with marine fossils? Atwater concluded that the old marsh flat and the coastal western redcedar forest had suddenly dropped down and been covered by Willapa Bay. Not *gradually, but instantly!* What could have caused this?

Atwater talked about his discovery to George Plafker, also of the USGS. Plafker told him that the same thing had happened after great subduction-zone earthquakes in southern Chile in 1960 and in the Gulf of Alaska in 1964. Coastal areas had subsided and had been inundated permanently by the sea, drowning forests and marshes. Atwater made the comparison and thought the unthinkable. The marshes and coastal forests of the Pacific Northwest had been downdropped during a great earthquake!

The evidence for earthquakes that I had been looking for was falling into place, and the news wasn't good. At this point, Don Hull, the State Geologist of Oregon, and I decided to hold a scientific workshop the evening before the Oregon Academy of Sciences meeting in Monmouth in February 1987, to address the question: *Is there a major earthquake hazard in Oregon or not?* We invited John Adams, Tom Heaton, and Brian Atwater, as well as other scientists, including skeptics who had previously advocated the idea that no earthquake hazard exists on the Cascadia Subduction Zone.

Everybody agreed to come, and the atmosphere was electric. The *Oregonian* newspaper got wind of the meeting, and their science writer, Linda Monroe,

wanted to cover it. I was nervous about having the press there because I wanted the scientists to be completely candid, not worrying about a front-page doomsday quote in a major newspaper. But Monroe asked me to trust her, and I did. Her coverage was responsible, and her presence did not detract from the give-and-take of the meeting.

As it turned out, Linda Monroe had a scoop. There was no argument, no controversy! Most of the scientists at the meeting were so impressed with the results presented by Adams, Heaton, and Atwater that the no-earthquake opposition retreated to the sidelines. The meeting marked a *paradigm change*, a fundamental change in our thinking about earthquakes in the Northwest. Attendees at the Oregon Academy meeting and readers of the *Oregonian* got the word the next day. Oregon, as well as the rest of the Pacific Northwest, is indeed Earthquake Country! None of us felt as safe after that day as we thought we had been the day before.

The third edition, updated nearly three decades later, tells the earthquake story of the Pacific Northwest. (This includes the west coast of Canada, and perhaps from a Canadian perspective, it should be the Pacific Southwest.) The book presents the evidence for earthquakes, the location of major faults, the danger from tsunamis, the importance of ground conditions, and what we as individuals and as taxpayers and voters can do to make our homes and our communities safer from earthquakes. There are lessons from the

Northwest experience to be learned elsewhere in the United States, Canada, and other parts of the world where the earthquake threat is greater than that perceived by the general public.

In 2013, encouraged by legislators representing coastal communities, state agencies convened a different set of meetings to address the question: what is the cost of doing nothing, or of taking only modest steps? The meetings included engineers, emergency managers, scientists, planners, political leaders, and members of the general public. These meetings led to appraisals of our area's *resilience* against the next subduction-zone earthquake. The results were published by the Cascadia Regional Earthquake Workgroup (CREW, 2013) and by the geological surveys of British Columbia, Oregon, and Washington.

This analysis showed that the costs of doing little or nothing would be catastrophic, with tens of thousands of deaths and many billions of dollars in damages. Areas struck by the next Cascadia earthquake would be devastated to the extent that some parts, particularly coastal regions, could take as long as a generation to recover. This would be a catastrophe unmatched in the history of the United States or Canada.

A major purpose of this book is to alert enough people so that this doomsday scenario doesn't happen. You, the reader, must be part of the solution.

We cannot prevent earthquakes, but we can learn to live with them and to survive them. When the inevitable earthquake strikes, we can be ready.

But today, we are not.

---

### *Suggestions for Further Reading*

Cascadia Regional Earthquake Workgroup, 2013, Cascadia Subduction Zone earthquakes: A magnitude 9.0 earthquake scenario and update, 2013, 23 p. Also available as Washington Division of Geology and Earth Resources Information Circular 116, Oregon Department of Geology and Mineral Industries Open-File Report O-13-22, and British Columbia Geological Survey Information Circular 2013-3.



# PART II

## PART II: TECTONIC PLATES, GEOLOGIC TIME, AND EARTHQUAKES

No one doubts that the Earth is the most hospitable planet in the solar system. We have a breathable atmosphere, and the temperature, as Goldilocks said about the porridge, is “just right.” Venus is too hot, Mars is too cold, and the Moon and Mercury have no atmosphere at all to speak of.

But in terms of earthquakes, the other planets could be considered safer places to live than the Earth. That’s because the Earth’s outer shell is broken up into great slabs called plates that jostle and grind against one another like huge ice floes. In the process, all that crunching between *plates* forces parts of the crust up to create mountains, causing earthquakes in the process. In contrast, the crust of the other inner planets consists entirely of massive rock that experienced most of its mountain-building activity billions of years ago, soon after the planets were formed. Now the crustal movements on these planets

have been stilled. There is no grinding of plates against one another to cause them to shake.

But the Earth has active volcanoes and earthquakes, which are geologic phenomena, and to understand them we need a brief introduction to their geologic setting. This requires us to stretch our minds to think about moving masses of rock that are extremely large, many tens of miles thick and hundreds of miles wide. We also must think of great lengths of time. Just as an astronomer asks us to think of great distances of hundreds of billions of miles, a geologist asks us to think about thousands, even millions of years. An earthquake may happen in less than thirty seconds, but it is a response to the slow motion of massive tectonic plates on the surface of the Earth, building up strain over many thousands of years.

How do we study earthquakes? We can see the effects of past earthquakes in fault ruptures on the Earth's surface. We can learn about earthquakes as they happen by the squiggles they make on a seismograph record. We can think about future earthquakes by measuring the slow buildup of tectonic strain in the Earth, using orbiting satellites and the Global Positioning System (GPS).

# I. A Concept of Time

*“What is time? The shadow on the dial, the striking of the clock, the running of the sand, day and night, summer and winter, months, years, centuries—these are but arbitrary and outward signs, the measure of time, not time itself.”*

Henry Wadsworth Longfellow, *Hyperion*

*“All moons, all years, all days, all winds, take their course and pass away.”*

Mayan proverb

The Earth’s crust seems pretty quiet most of the time. Although we now know that the Puget Sound region is seismically active, you and I can drive from Portland, Oregon, to Vancouver, B.C., along Interstate 5 and never feel an earthquake.

I was a graduate student at the University of Washington in the 1950s, and I never thought about earthquakes. If I had arrived in Seattle a half-dozen years earlier, I would have experienced a magnitude 7.1 earthquake in 1949 that did a lot of damage and caused loss of life. And if I had stuck around a few years longer, I would have been shaken by the Seattle Earthquake of 1965, which produced more damage and fatalities. Even though I didn’t feel anything during the short time I lived in Seattle, the Seattle area was experiencing

normal seismic activity during that time. Modern seismicity maps of the Puget Sound show lots of black dots, although most identify earthquakes that are too small to be felt by anything other than sensitive seismographs.

How long is a long time to a geologist? Look at Table 1, which shows a series of time scales, each encompassing a longer period of time than the last. The first scale is historical, the time of recordkeeping, starting with the arrival of Western explorers two centuries ago. The next two scales are in thousands rather than hundreds of years; the written history of the Pacific Northwest spans only a brief part of the Late Quaternary time scale. The Late Cenozoic scale is in millions of years, and the Older Earth History scale covers four and a half *billion* years.

OK, I'm a geologist, and I am supposed to think in these great lengths of time. But I still consider it a long time when I'm stuck in traffic on Interstate 5. When I was growing up, I thought it was an unacceptably long time until Christmas or my birthday. You may agree that it is a very long time before you graduate from college, or get your kids raised, or retire, and so it is probably tough to envision even the two hundred years people have been keeping records in the Northwest.

Now that I am older, I have learned to take a somewhat longer view of time (except when I'm stuck on the freeway). I knew both my grandfathers, who told me stories about the horse-and-buggy days. I enjoy reading about the early settlers in the Willamette Valley

and Puget Sound 150 years ago, and that, to me, seems an unbelievably long time ago.

But in fact, our recorded history in the Northwest (Historical Time Scale, Table 1) is short. The stretch of the coast from Alaska to California was the last region of the Pacific Rim to receive settlers willing to record their history, a fact that will become significant when we consider the great Cascadia Earthquake of A.D. 1700.

Spanish explorers reached the southern Oregon coast around A.D. 1600, and a Greek adventurer, Ioánnis Phokás, known by his name in Spanish, Juan de Fuca, may or may not have discovered the strait that bears his name. Captain George Vancouver and Spanish sea captains visited Puget Sound in the late 1700s, followed by Meriwether Lewis and William Clark, who arrived for a winter layover in 1806, complained about the rain, and went home. But they did blaze the trail, and fur traders set up posts at Fort Vancouver and Astoria. Soon after, many settlers from the eastern United States came to Oregon (which, as the Oregon Territory, included at that time most of the Pacific Northwest south of Canada). New towns were established west of the Cascade Mountains, and along with towns and farms, people built roads, established land claims, and started newspapers. By the 1840s, less than two centuries ago, people were keeping written records more or less continuously throughout the area west of the Cascades. This means that we know only that the Pacific Northwest has been free of great earthquakes since

that time. To a geologist, that is not a very long time, not at all.

Native Americans were here long before that, of course, but they did not keep written records. Their rich oral traditions are another matter, though, and some of their stories document great earthquakes and earthquake-induced waves from the sea.

To a geologist, two centuries is like the blinking of an eye. The Earth is more than four and a half billion years old. The evidence from the rocks shows that the Pacific Northwest is much younger than that, and only in northeastern Washington and adjacent Idaho and British Columbia do we find rocks that are more than a billion years old. Most of the rocks in western Washington and Oregon are less than sixty million years old. But that is still an incredibly long time. A geologist can easily *talk* about sixty million years, but it is just as hard for a geologist to *imagine* such a long period of time as it is for anybody else.

If the length of time that geologic processes have operated in the Northwest is unimaginably long, the rates of these processes are incredibly slow, about as fast as your fingernails grow.

**Table 1. Time Scales**

---

**HISTORICAL**

|         |   |
|---------|---|
| 2000    | Age of computers, logging cutbacks, decline in state services, increased population, Nisqually Earthquake in 2001                               |
| 1980    | Mt. St. Helens erupted. Space exploration and men on the Moon; Vietnam War  |
| 1960    | U.S. interstate highway network. End of World War II atmospheric testing of nuclear weapons   |
| 1940    | Roaring Twenties followed by the Great Depression and World War II  |
| 1914-18 | World War I   |
| 1900    | Extensive logging and development of farmland; autos replaced horses  |
| 1880    | Development of rail network   |
| 1860    | U.S. Civil War; present U.S.-Canada border established after the Pig War in the San Juan Islands  |
| 1840    | Pioneers headed west to Oregon; settlement of Willamette Valley, Puget Lowland, Fraser Delta, southern Vancouver Island, newspapers established |
| 1820    | Astoria and Fort Vancouver fur trade centers established  |
| 1800    | Native Americans were in charge, but left no written records. Lewis and Clark expedition began great westward migration                         |
| 1780    | Explorers reached coasts of British Columbia, Washington, and Oregon  |
| 1700    | Cascadia Subduction Zone Earthquake recorded by tsunami in Japan  |
| 1600    | Spanish explorers reached southern Oregon coast   |

## LATE PREHISTORIC

- 2000 Today. Last great subduction-zone earthquake  
Jan. 26, 1700
- 1500 Columbus discovered America but not the Pacific  
Northwest
- 1000 Large earthquake(s) on Seattle Fault around A.D.  
900
- 500 Three subduction-zone earthquakes between A.D.  
500 and 1000. Long interval with no earthquakes  
between B.C. 500 and A.D.500

## LATE QUATERNARY

B.P., which used to mean “Before the Present” before  
nuclear fallout messed up our dating scales, now means  
“Before A.D. 1950”

- A.D.  
2000 Today.
- 5,000  
B.P. Same as B.C. 3000; 5,000 years before A.D. 1950.  
Sea level approached present position; Mt.  
Mazama erupted to form Crater Lake
- 11,700 End of Pleistocene and beginning of Holocene. Sea  
level rising. Eighteen subduction-zone  
earthquakes during the Holocene. Great Missoula  
floods 15,000 to 12,000 years ago
- 15,000 Ice caps retreating and sea level rising rapidly
- 20,000 Glacial ice as far south as Olympia and Spokane,  
Washington; shorelines nearly 400 feet lower than  
today

## LATE CENOZOIC (Age, in thousands of years)

- 0 Today. Sea level is 20 feet lower today than  
124,000 years ago
- 500 500,000 years. Several ice advances and retreats.  
Earth’s magnetic field reversed at 780,000 years;  
previously, compass needle pointed south



|       |   |
|-------|---|
| 1,000 | More glacial advances and retreats  |
| 2,600 | Beginning of Pleistocene <u>2,600,000 years ago</u>   |
| 2,000 | Pliocene Epoch  |
| 2,500 | First major ice age started about 2,400,000 years ago. Still in the Pliocene, which started about 5,300,000 years ago |

**OLDER EARTH HISTORY** (Age, in millions of years)

|       |   |
|-------|---|
| 0     | Today   |
| 2.4   | Beginning of Ice Ages   |
| 15-17 | Great eruptions of Columbia River Basalt                        |
| 66    | Asteroid slammed into southern Mexico, dinosaurs became extinct |
| 245   | Greatest mass extinction in the history of the Earth            |
| 570   | Beginning of trilobites and shelly fossils                      |
| 4,570 | Age of the Earth, 4,570,000,000 years                           |

---

When I talk about the motion of the oceanic plate northeastward toward Oregon, Washington, and Vancouver Island, and I say that the motion is a little more than an inch and a half per year, I sometimes lose my audience. Here we're talking about increasing the speed limit on Oregon freeways, and this guy is worried about speeds of an inch and a half a year? Give us a break! But this rate is faster than the rate of a little more than an inch per year at which coastal California is grinding past the rest of North America on the San Andreas Fault. Even with that slow rate of travel, the San Andreas Fault has had great earthquakes in 1812,

1857, and 1906. If you continue this slip rate for five million years, coastal California will move northwest more than eighty miles. Keep that up long enough, and—hold your breath—Los Angeles will become part of the Pacific Northwest!

Let's suppose that one gigantic earthquake ruptured the entire Cascadia Subduction Zone in 1700 AD, prior to the start of record keeping in the region, and caused displacement of 65 feet, which many scientists believe is possible. And let's suppose also that this earthquake relieved all the strain that had been slowly building up at a rate of 1.6 inches per year. Dividing 1.6 inches per year into 65 feet, you find that it would take almost five hundred years for the crust to recover that strain, so that the subduction zone could rupture again in the next earthquake. Now that's a long time, about two and a half times our recorded history in the Pacific Northwest since the expedition of Lewis and Clark.

But we've already used up more than two hundred years of recorded history with no monster earthquake, and, as will be shown below, there is geologic evidence from Brian Atwater's subsided marshes and historical evidence from a tsunami in Japan in 1700 AD that we have already used up more than three hundred years. Should we forget about it, inasmuch as we still might have two hundred years to go?

Unfortunately not, because the repeat time of earthquakes can be highly variable. In southern California, a section of the San Andreas Fault ruptured in 1812 and again in 1857, just forty-five years later. Yet

more than one hundred and fifty years have gone by without another major earthquake along that same section of the fault. The southernmost part of the San Andreas fault has not had a major rupture in more than 300 years. The Cascadia Subduction Zone could have much longer than two hundred years to go, or we could have the next great Cascadia earthquake much sooner, maybe in our lifetime, maybe tomorrow.

Another reason that we can't laugh at 1.6 inches per year is the massive amount of rock that is building up strain. The oceanic slab that is forcing its way under the edge of the North American continent is about 40 miles thick and 740 miles long, extending from Vancouver Island to northern California. So, even though the movement rate is slow, the bodies of rock that are being strained are titanic in size.

Because the times for geologic processes to work are so ponderously long, geologists have devised time scales (see Table 1), analogous, perhaps, to historians referring to the Middle Ages or the Renaissance. At first, this was done using fossils, because organisms have changed through time by evolution, and distinctive shells or bones of species that had become extinct were used to characterize specific time intervals called *periods* and *epochs*. In the past few decades, it has become possible to date rocks directly, based on the extremely regular rate of decay of certain radioactive isotopes of elements such as uranium. These atomic clocks enable us to date the age of the Earth at about four and a half billion years and, in addition, to date the

age of trilobites, of dinosaurs, and of other dominant groups of organisms that are now extinct.

In our study of earthquakes, we do not need to be concerned about most of the geologic periods and epochs, including the ages of trilobites and dinosaurs. We do need to know about those times when the geologic processes that produce today's earthquakes have been operating: the Tertiary and Quaternary periods, together known as the Cenozoic Era. We need to know something about the geologic history of the later part of the Tertiary Period, but we are most concerned about the Quaternary, which started 2.6 million years ago (Table 1). We divide the Quaternary into the Pleistocene and the Holocene epochs, with the boundary between the two dated at about eleven thousand years ago. The Pleistocene Epoch, covering most of the Ice Ages, saw much of the evolution of human beings, as well as saber-tooth tigers, mastodons, and great cave bears.

But it is the Holocene, the last 11,700 years, that concerns us most. During the latest Pleistocene and early Holocene, the great ice caps of North America and Europe melted away, and the addition of all that meltwater to the world's oceans caused sea level to rise hundreds of feet. During the last half of the Holocene, civilizations arose in Mesopotamia, Egypt, and China, and written records began to be kept.

If geologists can show that a fault sustained an earthquake during the Holocene, it is placed in a special category of *hazard*. If it ruptured that recently, it is

likely to rupture again, and it is called an *active fault*. This classification based on the time of most recent activity is written into law in some states and into regulations by federal agencies such as the U.S. Nuclear Regulatory Commission and the U.S. Army Corps of Engineers.

To learn the age of an earthquake, we have written records only for the last part of the Holocene, and for the Pacific Northwest, the historical record only slightly longer than two hundred years. But we can use one of the nuclear clocks to date formerly living organisms for the last twenty to thirty thousand years. This is *radiocarbon dating*, based on the natural decay of a radioactive isotope of carbon (carbon 14) into stable carbon (carbon 12). Carbon 14 starts off as ordinary nitrogen, which makes up the greater part of the atmosphere. The stable isotope of nitrogen, nitrogen 14, is bombarded by cosmic rays from outer space, changing it to carbon 14, which is radioactive and unstable. Organisms, including you and I, take up both the radioactive and stable isotopes of carbon in the same proportions as in the atmosphere. After the organism dies, carbon 14 decays to carbon 12 at a precise rate, so that half of the carbon 14 is gone in 5,730 years. In another 5,730 years, half of what's left decays to carbon 12, and half of *that* decays in another 5,730 years, until finally there is too little radioactive carbon 14 to measure. We say that 5,730 years is the *half-life* of the radioactive decay of carbon 14 to carbon 12.

Unfortunately, the radiocarbon clock is not as precise as we would like. Radiocarbon dating cannot get us to the exact year, but only to within a few decades of the actual age. An example of a radiocarbon age is  $5,300 \pm 60$  radiocarbon years, an expression of the laboratory precision in counting the atoms of carbon 14 relative to carbon 12. Radiocarbon years are not the same as “calendar” years because the cosmic radiation that creates carbon 14 is not constant, but has changed over the years. Minze Stuiver and his colleagues at the University of Washington designed a conversion scale that changes radiocarbon years to calendar years, and in most reports today, this conversion has already been made, using a computer program. A radiocarbon age or a calendar age of, say, 5,300 years is stated as 5,300 years B.P., meaning Before Present. But “Present” is not really today, because the atmospheric fallout from nuclear weapons testing after World War II completely messed up our dating. To get around that, we refer to “present” as A.D. 1950.

In addition, the geologist or archaeologist must ensure that the carbon sample being dated (charcoal, shell fragment, bone fragment) is the same age as the deposit in which it is found. The charcoal in a deposit may have been washed in from a dead tree that is hundreds of years older. Or the charcoal may be part of a root from a much younger tree that grew and died long after the deposit was buried by other sediment.

Finally, the ratio of carbon 14 to carbon 12 in lakes and in parts of the ocean may not be the same as it

is in the atmosphere. To accurately date the remains of organisms that died in these environments, it is necessary to figure out what the carbon isotope ratios are under these conditions and make a *reservoir correction*.

To conclude our discussion of time, we need to think of earthquakes in two ways. On the one hand, an earthquake takes place in a matter of seconds, almost (but not quite) instantaneously. But on the other hand, an earthquake marks the release of strain that has built up over periods of hundreds, thousands, even tens of thousands of years. We use radiocarbon dating to learn how long it has taken strain to build up enough to break a large mass of rock in an earthquake over the last thirty thousand years. We can also use tree rings to determine within one year when a particular tree growing in a coastal forest was suddenly buried below sea level.

To understand the earthquake hazard, it is not enough to figure out *what* will happen in a future earthquake. To make progress in forecasting earthquakes, we need to know *how long* it takes a fault to build up enough strain to rupture in an earthquake, and *how large* that earthquake is likely to be. When? Where? How big? On the answers to those questions rests our ability to respond to the earthquake danger and to survive it.

## *Suggestions for Further Reading*

- Levin, H. L., 1999. *The Earth Through Time*, Sixth Edition. New York: Saunders College Publishing, 568 p., 7 appendices.
- Pellegrino, C. R. 1985. *Time Gate: Hurling Backward through History*. Blue Ridge Summit, PA: TAB Books, Inc., 275 p. An explanation of the vastness of time by looking backward through ever-increasing time spans to the very beginning; written for the lay person. Table 1 is based on this idea.
- Wicander, R., and J.C. Monroe, 2012, *Historical Geology*, 7th Edition. CENGAGE Learning, print or ebook.
- Yeats, R. S., K. E. Sieh, and C. R. Allen. 1997. *The Geology of Earthquakes*. New York: Oxford University Press, Chapter 6, p. 116-38.



## 2. Plate Tectonics

*“Plate motions have built the topography that has induced the weather that has brought the fire that has prepared the topography for city-wrecking flows of rock debris. Plate motions are benign, fatal, eternal, causal, beneficial, ruinous, continual, and inevitable.”*

John McPhee, 1994, *New Yorker*  
after the Northridge Earthquake

### I. The Earth’s Crust: Not Very Well Designed

As an engineered structure, the Earth’s crust is not up to code. From time to time, its design problems cause it to fail, and the result is an earthquake.

The principal cause of crustal weakness is geothermal heat. Isotopes of radioactive elements within the Earth decay to other isotopes, producing heat that is trapped beneath the surface. Because of this trapped heat, the crust is warmer with increasing depth, as anyone knows who has ever descended into a deep mine. Geothermal heat warms the City of Klamath Falls, Oregon, heats the hot springs of the

Pacific Northwest, and, on rare occasion, causes the eruption of great volcanoes like Mt. St. Helens.

Just as iron becomes malleable in a blast furnace, or hot silica glass becomes soft enough for a glassblower to produce beautiful bowls, rock becomes weak, like saltwater taffy, when the temperature gets high enough (Figure 2-1). Rock that is soft and weak under these conditions is said to be *ductile*. At lower temperatures, rock is *brittle*, meaning it deforms by shattering, accompanied by earthquakes.

Increased temperature tends to weaken rock, but, on the other hand, increased *pressure* tends to *strengthen* it. With increasing depth, rock is subjected to conditions that work in opposite directions. The strengthening effect of increased pressure dominates at low temperatures within ten to twenty miles of the Earth's surface, whereas the weakening effect of higher temperature kicks in rather abruptly at greater depth, depending on the type of rock. The strength of rock, then, increases gradually with increasing depth, and the strongest rock is found just above the depth where temperature weakening takes over (Figure 2-1), a depth called the *brittle-ductile transition*.

Think about a bridge with a layer of asphalt and concrete overlying a framework of strong steel. If the bridge collapses, it will be because the steel frame fails, not the weaker layers of concrete or asphalt on top. So it is with the Earth's crust. The crust fails when its strongest layer breaks, just above the brittle-ductile transition where temperature begins to weaken its

minerals. Earthquakes tend to originate in this strongest layer. When this layer fails, shallower and deeper rock fails, too.

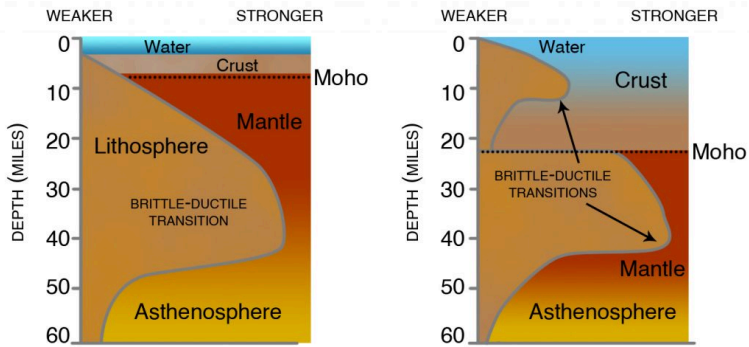

Figure 2-1. Strength of continental lithosphere (crust and upper mantle, above right) compared to oceanic lithosphere (above left). As rocks get buried, they get hotter due to the Earth's geothermal gradient. They also get stronger—down to a point, where temperature takes over, and they abruptly get weaker, at a level called the brittle-ductile transition. The Mohorovičić discontinuity (Moho for short) marks the boundary between the crust, made up of granite and basalt, and the mantle, made up of peridotite. Temperature softens granite at a much shallower depth than peridotite, so that the lower continental crust is a soft, squishy layer between the brittle upper crust and the brittle upper mantle. Earthquakes are limited to the brittle layers of continental crust, and they tend to nucleate where the crust is strongest, just above the brittle-ductile transition to soft, plastic lower crust. For oceanic lithosphere, the Moho is so shallow that there is no soft layer. The hard lithosphere makes up the tectonic plates. The base of the lithosphere is where peridotite in the mantle becomes soft at high temperature. The soft stuff beneath is the asthenosphere. From Yeats et al. (1997), with permission

## 2. Continents and Ocean Basins

Unlike the other inner planets, the surface of the Earth is at two predominant levels, one averaging 2,750 feet (840 m) above sea level, making up the continents, where we all live, and the other averaging 12,100 feet (3,700 m) below sea level, making up the ocean basins (Figure 2-2). If you were able to look at the Earth with the water removed, the continents, together with their submerged continental shelves, would appear as gigantic plateaus, with steep slopes down to the ocean basins below (Figure 2-3a, b, 2-4). With the seawater removed, the dry land of the North American continent would appear as a high plateau relative to the deep-sea floor.

Figure 2-3a shows the Earth with the water removed. Continents are large plateaus above sea level, and ocean basins, in blue, show *oceanic spreading centers* in very light blue and *trenches*, marking subduction zones, in very dark blue. Figure 3b shows the Earth divided into tectonic plates, with subduction zones marked by heavy black lines and *ocean spreading centers* by narrower lines. Large earthquakes are shown as red dots. Note the Pacific Ring of Fire. Figure 2-4 shows the Gorda Plate with the water removed, with narrow lines marking the present and former position of the Gorda spreading center. Most earthquake energy is released along these plate boundaries, although the spreading centers are also marked by earthquakes (Figure 2-5).

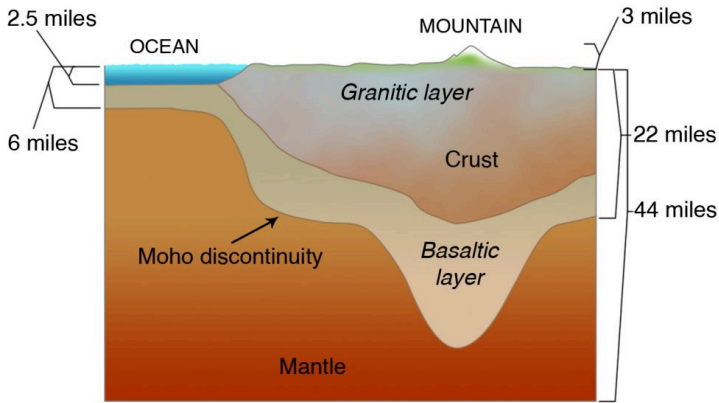

Figure 2-2. Cross section of oceanic crust (left) and continental crust (center and right). Continent is composed of granitic rock which is lighter, thicker, and more buoyant than oceanic crust, which is underlain by heavier basaltic rock. Both continental and oceanic crust overlie the mantle, composed of peridotite. The top of the mantle is the Moho. The continent stands high with respect to the ocean basin, and for it to be in balance, it's underlain by a deep root of lighter crust. Mountain ranges stand above the continent and are underlain by still deeper roots. From Yeats et al. (1997), with permission

Imagine yourself flying northward along the northern California coast with all the seawater removed (Figure 2-4). You would look westward from the Oregon and northern California Coast Range to a narrow continental shelf, which, indeed, was dry land at the height of the ice ages when sea level was nearly four hundred feet lower than it is today. Beyond that, the land slopes downward for thousands of feet to the present deep ocean floor, part of the Gorda Plate

(Figure 2-6). North of the Columbia River, the deep slope off the coast of Washington is cut by a series of twisting canyons rivaling the Grand Canyon in size. The Strait of Juan de Fuca is a broad valley separating the Olympic Peninsula from Vancouver Island, which is itself connected to the mainland by a series of islands. Puget Sound is another valley, similar to the Willamette Valley. But it is the steep slope between the continental shelf and the deep ocean floor that dominates the scene. It's as though people living on the Pacific coast were in Tibet, looking down to the plains of India far below (figures 2-3a, 2-4).

The reason for the different levels is that the continents and ocean basins are made up of different kinds of rock. Continental rocks are rich in the light-colored minerals quartz and feldspar, which combine to make up the principal kind of rock in the continent, which is *granite* (Figure 2-2). You can find good exposures of light-colored granitic rocks in the Coast Mountains of British Columbia, the North Cascades of Washington, including the Alpine Lakes Wilderness Area east of Seattle, the Wallowa Mountains of Oregon, and the Sierra Nevada of California (which John Muir, because of their light color, called “The Mountains of Light”).

Ocean-basin rock, on the other hand, is predominantly *basalt*, which contains the light-colored mineral feldspar but is dark brown to black, because its color is dominated by dark minerals like pyroxene and magnetite. The mountains on the east side of the

Olympic Peninsula, visible from Seattle on a clear day, are composed of basalt, with most of it deposited on an ancient ocean floor about fifty-five million years ago. Basalt lava flows also characterize the Columbia Plateau and Columbia Gorge, although these rocks were formed on the continent, not in an ocean basin. Basaltic rocks are common on other planets, whereas continental granitic rocks are not.

A third type of rock called *peridotite* underlies both the continents and the ocean basins, and this is made up of dense minerals such as pyroxene and olivine. This dark rock has no feldspar and thus it is heavier than either basalt or granite. Peridotite is also brittle and strong at much higher temperatures than either basalt or granite, a fact that will become significant when we consider in Chapter 5 the environment of deep earthquakes beneath the Puget Sound region.

Peridotite does not form naturally at the Earth's surface. It is found at the surface only in special circumstances where great tectonic forces have raised it up to view. As it comes to the surface, it absorbs water, and the green streaky rock that results is called *serpentine*, which has been designated the state rock of California. Serpentine and peridotite are found at various places in the North Cascades of Washington, the Blue Mountains of Oregon, and the Klamath Mountains of Oregon and northern California. From a distance, terrain underlain by peridotite or serpentine may appear a weathered reddish brown, and it does not support as much vegetation as other types of rock.

The Twin Sisters range east of Bellingham, Washington, is made up almost entirely of olivine, one of the minerals in peridotite, and the mountains south and west of Mt. Stuart, in the North Cascades north of Ellensburg, Washington, are made up of peridotite.

During the four and a half billion years of Earth history, convection currents sweeping at extremely slow speeds through the Earth's interior have resulted in the gradual accumulation of granite and basalt near the surface, much like scum floating on the top of a large pot of slowly boiling soup. Granite and basalt float on top because they are lower in density than peridotite.

Basalt and granite make up the *crust*, and the underlying heavy peridotite makes up the *mantle*, which extends all the way down to the top of the molten outer core of the Earth at 1,800 miles (2,900 kilometers) depth. The boundary between the crust and the mantle is called the *Moho* (Figures 2-1 and 2-2), shorthand for the name of the Croatian seismologist, Andrija Mohorovičić, who discovered it in 1909. The Moho beneath the continents is commonly at depths of 20 to 40 miles (35 to 70 kilometers), deepest beneath mountain ranges, whereas the Moho beneath ocean basins may be no more than 6 miles beneath the sea floor.

The continents, made up of granite, which has relatively low density, stand higher than the ocean basins underlain by basalt and peridotite for the same reason that icebergs float on the ocean, or ice cubes



float in a glass of ice tea. And if you look at the ice cubes in your tea, you will see that there is quite a lot of ice below the surface of the tea. This ice of lower density beneath the surface balances and buoys up the ice that sticks up above the water. For the same reason, the granitic crust of the continents extends to depths in the Earth much greater than the basaltic crust of the ocean basins (Figure 2-2). The basaltic crust beneath ocean basins is relatively thin, and its relation to the mantle is more like the water freezing on the surface of a pond.

But how can we use ice and water as a comparison with solid rock? Water is a liquid, and the crust and mantle are solids.

This comparison is valid for two reasons. First, rock at great depth is weak because it is subjected to blast-furnace temperatures beneath the brittle-ductile transition. Second, the tectonic processes that cause continents to rise above ocean basins are extremely slow. We know from experiments that if the temperature is high enough, rock can flow as a solid, although it does so very slowly, fractions of an inch per year. This process, well known in metalworking, is called *hot creep*.

We have seen that earthquakes occur in the brittle upper crust, but not in the hot, plastic lower crust which is too weak to store strain energy that could be released as earthquakes. The reason for this is the abundance in the crust of the light-colored minerals quartz and feldspar, minerals that become soft and

weak at relatively low temperature, about 575° F. For this reason, the upper crust beneath the continents is strong, but the lower crust is soft and weak. Oceanic crust, on the other hand, is so thin (Figure 2-2) that *all* of it is strong, and so is the upper mantle. Peridotite, the rock of the mantle, is made up of olivine and pyroxene, minerals that are still very strong at temperatures that prevail below the Moho, as high as 1,400-1,500°F. These temperatures are reached at depths that may be as much as sixty miles (one hundred kilometers).

The part of the outer Earth that is brittle and strong is called the *lithosphere*, and the weak part below is called the *asthenosphere*. Beneath the ocean basins, the lithosphere includes the thin crust and part of the upper mantle. Beneath the continents, the upper crust is brittle, but the lower crust is not. Below the Moho, the upper mantle may also be brittle and form the lowest layer of continental lithosphere. So the continental crust can be compared to peanut butter between two crackers; both crackers are crunchy (brittle), but the peanut butter is soft (ductile lower crust). For oceanic lithosphere, you don't have any peanut butter, and the crunchy cracker is a lot thicker.

The flow of solid rock in the asthenosphere produces strain in the strong lithosphere. It is the response of the lithosphere to this strain that causes earthquakes. All earthquakes occur within the lithosphere, including slabs of oceanic lithosphere that

have been forced downward hundreds of miles into the asthenosphere.

### 3. The Dance of the Plates: We Know the Beat, but Not the Tune

The dominant cause of the tectonic activity that takes place at the Earth's surface is the extremely slow flow of rock in the mantle that is solid, yet ductile. This leads us now to a discussion of *plate tectonics*.

We would have no earthquake problem if the lithosphere, 60 miles thick, completely encircled the Earth without any breaks, as it does on the other inner planets. Unfortunately, though, the 60-mile thickness of the lithosphere on the “third rock from the sun” is not enough to withstand the stresses coming from the slow, roiling currents of the asthenosphere below. The lithosphere is broken up into gigantic *tectonic plates* (Figure 2-3a, 2-3b, 2-4) that grind against one another, producing earthquakes and volcanic eruptions in the process. Most of these plates are of continental size. The Pacific Northwest is part of the North American Plate, which extends all the way across the United States and Canada to the middle of the Atlantic Ocean (Fig. 2-3b). Most of the Pacific Ocean is underlain by the Pacific Plate, the world's largest, which reaches to Alaska, Japan, and New Zealand (figure 2-3b). Other

plates are smaller, like the Juan de Fuca Plate off the Pacific Northwest coast, which is a little smaller than Washington and Oregon taken together (Fig. 2-4b).

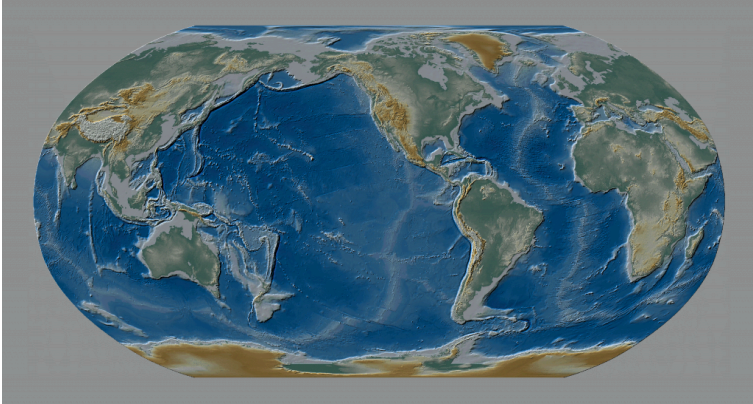

Figure 2-3a. World map with oceans removed. Ocean floor in shades of blue; lightest bands show oceanic spreading centers (Mid-Atlantic Ridge, East Pacific Rise) and very dark bands show trenches, the boundaries of subduction zones. Light band at west edge of North America locates continental slope, at base of which is Cascadia Subduction Zone.

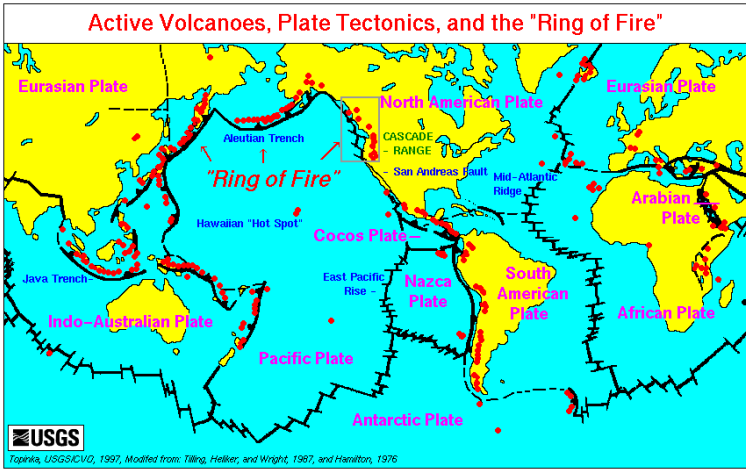

Figure 2-3b. Earth's surface divided into tectonic plates. Thickest boundaries: subduction zones; thinner lines: spreading centers. Red dots locate active volcanoes, largest adjacent to subduction zones. Note location of Ring of Fire, of which Cascadia (open rectangle) is a part.

Running down the center of the floor of the Atlantic Ocean, like the seam on a baseball, the Mid-Atlantic Ridge (Figures 2-3a, b) is formed by the upwelling of hot material from the asthenosphere, which broke up the granite supercontinent of Pangea, starting about one hundred and eighty million years ago. North and South America, fragments of Pangea, sailed away from Africa and Eurasia like great granitic ice floes in a basaltic sea, and the deep Atlantic Ocean floor of basalt began to grow in the widening rift welling up between the continents. The Atlantic Ocean Basin is still widening at a rate slightly less than an inch per

year. The Mid-Atlantic Ridge is a ridge (lighter blue, Figure 2-3a) because the newly formed oceanic lithosphere is hotter and thus lighter and more buoyant than older oceanic lithosphere closer to the continents. There are hot springs along the ridge, called *black smokers* (first discovered by marine scientists from OSU), and new basaltic lava flows erupt on the ocean floor at the ridge. All of the ocean floor of the Atlantic has been created as basaltic lava in the past one hundred and eighty million years.

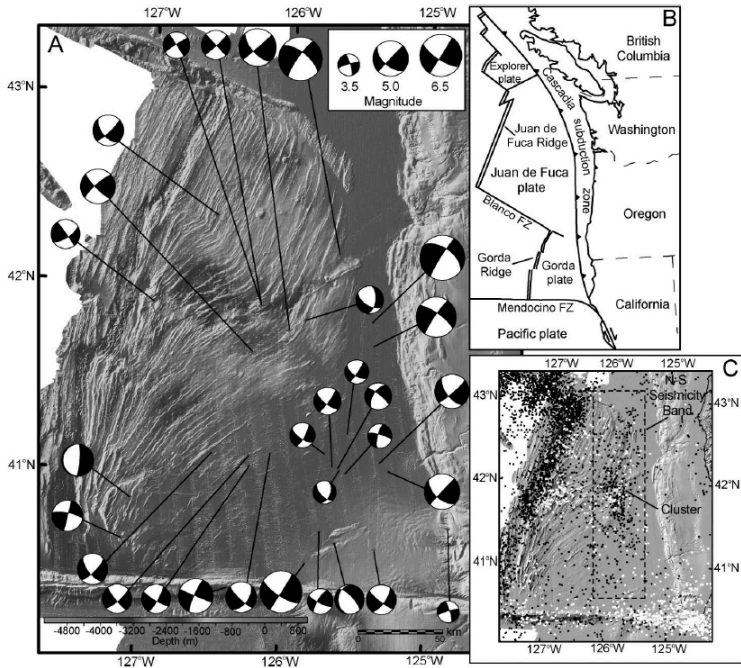

Figure 2-4. A sonar image of Gorda Plate, in which lines represent former positions of the Gorda Ridge spreading center, the current location of which is at the lower left. At bottom, east-west ridge is Mendocino Fracture Zone (FZ) between Gorda and Pacific plates. At upper left is Blanco Fracture Zone. Cascadia Subduction Zone is at far right, between Gorda Plate and North American Plate. Circles (beach balls) represent fault-plane solutions, described in Chapter 3; see Fig. 3-19. B. Plate tectonic map of Cascadia. C. Dots locate microearthquakes measured by seismographs and hydrophone arrays.

There is also a ridge in the Pacific Ocean called the East Pacific Rise, but this ridge is not at the center of the ocean, like the Mid-Atlantic Ridge. Instead, it lies

toward the eastern margin of the Pacific (Figures 2-3a, b). But its origin is the same: oceanic crust rises to the surface and solidifies at the East Pacific Rise, then it moves away to the east and west. That part moving toward the west becomes part of the great Pacific Plate. That part moving toward the east becomes part of several smaller plates off the west coast of North and South America, including the Juan de Fuca Plate off the Pacific Northwest (Figure 2-4b, 2-6), and the Cocos Plate off Mexico and Central America (Figure 2-3b). These plates drive against and beneath the American continents.

But if new crust is being made, then old crust must be destroyed at the same rate somewhere else, because the Earth has remained the same size through time. The destruction of crust takes place at *subduction zones*, where oceanic lithosphere sinks down into the asthenosphere. Most subduction zones are found around the edges of the Pacific Ocean, which leads to the name *Pacific Ring of Fire* (Figure 2-3b) because of the abundance of active volcanoes and earthquakes, including the largest earthquakes experienced on Earth. The greatest depths in the oceans, nearly seven miles, are found in deep-sea trenches in the western Pacific (Figure 2-4, 2-5), where oceanic lithosphere is being subducted beneath the Philippines and beneath the Marianas Islands and the island of Guam. Volcanoes are erupted through the lithosphere of the plate on top.

One of these subduction zones, the *Cascadia*



*Subduction Zone*, lies off the Pacific Northwest, including northern California, where the Juan de Fuca, Gorda, and Explorer plates are being driven beneath the North American continent (Figures 2-4, 2-5, 2-6). Mt. Baker, Mt. Rainier, Mt. St. Helens, Mt. Hood, Mt. Shasta, and Mt. Lassen are products of the subduction of the Juan de Fuca and Gorda plates. The Cascadia Subduction Zone is discussed further in Chapter 4.

At some plate boundaries, lithosphere is neither created at a mid-ocean ridge nor destroyed at a subduction zone. Instead, two plates crunch and grind past each other, producing earthquakes in the process. These boundaries are called *transform faults*, and on the ocean floor, they are called *fracture zones*. The best known transform fault on Earth is the San Andreas Fault of California (lower right corner of Figure 2-4b, Figure 2-6), where the Pacific and North American plates grate past each other. Off the Pacific Northwest, part of the boundary between the Juan de Fuca-Gorda and Pacific plates is the Blanco Fracture Zone, separating the Gorda and Juan de Fuca ridges (Figures 2-4c, 2-6, 2-7). Both the San Andreas Fault and the Blanco Fracture Zone are major sources of earthquakes.

Scientists are able to determine the rates at which the plates move with respect to one another. This is done by observing changes in the Earth's magnetic field preserved in oceanic crust (Figure 2-6) and by drilling core holes in the deep-ocean floor to determine the age of the oldest sediment overlying the

basaltic crust in various parts of the oceans. In the last few years, these rates have been confirmed by direct measurements using space satellites through the Global Positioning System (GPS) and by the relative motion of radio telescopes with respect to quasar signals from outermost space (discussed further in Chapter 3). All our information about relative plate motion can be fed into a computer model that tells us the motion of any given plate with respect to any other. We can even predict with some confidence the plate configuration of the Earth millions of years from now, which allows us to forecast that coastal California, including Los Angeles, is moving slowly but inexorably toward Alaska (video, Fig. 2-8).

However, we have no underlying theory that explains *why* the plates move as they do, which leads to our description of the dance of the plates: we know the beat, but we don't know the tune.

## World Seismicity 1977-1992

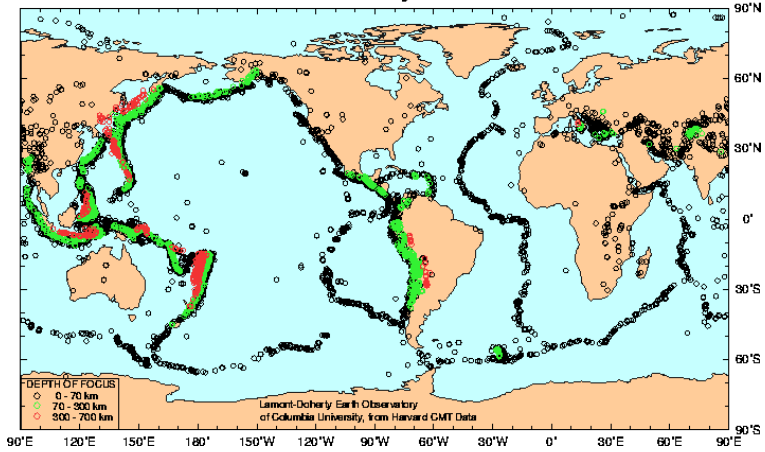

Figure 2-5. World map of seismicity, showing larger earthquakes. Most (but not all) earthquakes follow plate boundaries. Colors adjacent to subduction zones show earthquake focal depths: green for depths 70-300 kilometers, red for deeper earthquakes to 700 km. No color indicates earthquakes shallower than 70 km.

Near the tiny settlement of Petrolia in northern California, the Pacific, North America, and Gorda plates come together in a seismically active place called the *Mendocino Triple Junction* (Fig. 2-7). North of the triple junction, the Gorda Plate is driving beneath the North American continent (Figures 2-4 and 2-8). Southeast of the junction, North America is sliding southeast against the Pacific Plate along the San Andreas Transform Fault. West of the junction, the Pacific Plate is sliding westward against the Gorda Plate along an oceanic transform fault called the

Mendocino Fracture Zone (Figures 2-4, 2-6, and 2-7). We know the rates at which these processes are taking place, and so we can reconstruct the plate tectonic history of western North America backward for the past thirty million years.

## **4. A Brief Thirty-Million-Year History of Western North America**

Using sophisticated computer models, it is fairly straightforward to work out the plate-tectonic history of the Earth for hundreds of millions of years. This is illustrated in five stages in Figure 2-7, based on a copyrighted video created by Prof. Tanya Atwater of the University of California Santa Barbara through its Educational Multimedia Visualization Center and shown here as Figure 2-8. For an explanation in greater depth, see Atwater (1989).

What did the Pacific Northwest look like thirty million years ago?

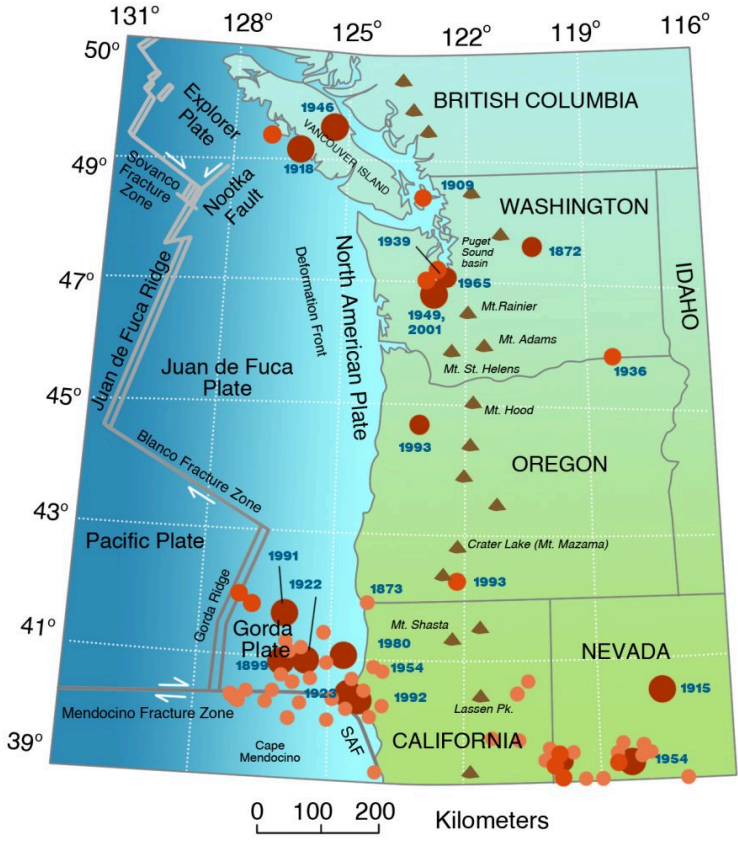

Figure 2-6a. Plate tectonics of the Pacific Northwest. Oceanic crust is formed at the Juan de Fuca Ridge and Gorda Ridge and a ridge west of the Explorer Plate (double lines), adding to the size of the Pacific Plate to the west and the Gorda, Juan de Fuca, and Explorer plates to the east. The plates east of the spreading center are carried beneath North America at the Cascadia Subduction Zone (see Figure 2-5) at the deformation front. Beneath the continent, they give rise to the Cascade volcanoes (shaded triangles). Shaded circles locate larger earthquakes (see also Appendix A). Offshore earthquakes on Blanco Fracture Zone and in and around the Explorer Plate not shown. SAF, San Andreas Fault. Modified from USGS.

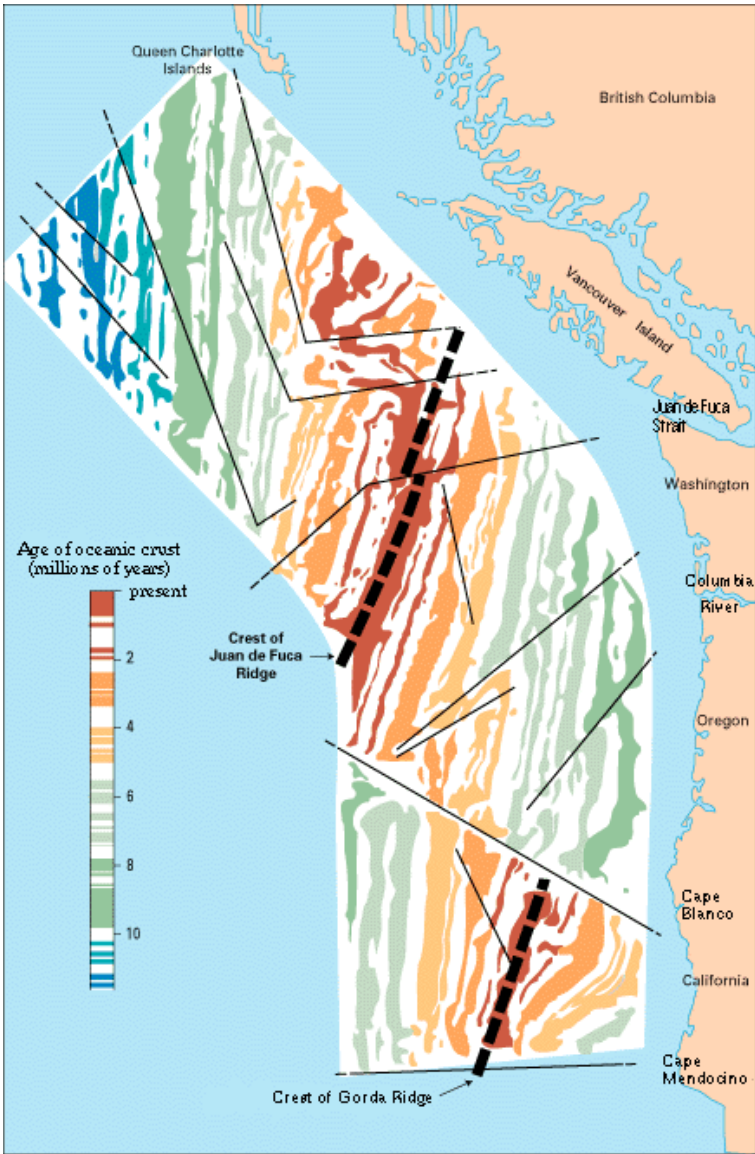

Figure 2-6b. Magnetization map of Cascadia. Colored bands show oceanic crust of normal polarity (magnetic needle points north), and colorless bands show crust of reversed polarity (needle points south). Because we know the age of boundaries of

*bands by dating volcanic rocks and the age of sediments directly overlying oceanic crust, we can determine the rate of separation of the Juan de Fuca and Gorda ridges. Compare this image with Figure 2-4, which shows the topography of the Gorda Plate.*

At that time, the oceanic crust west of North America formed part of the Farallon Plate, not the Pacific Plate (Figure 2-7, 2-8), and the Farallon Plate was being subducted beneath North America. The Farallon Plate and Pacific Plate were separated by the East Pacific Rise, part of the world-encircling mountain system that marks where new oceanic crust is formed (Figure 2-3) and spreads away, and by the Mendocino Transform Fault, which at that time was west of what would later become Los Angeles (Figures 2-7, 2-8). The Baja California peninsula was part of the Mexican mainland, with no Gulf of California in between.

Sea-floor spreading on the Mid-Atlantic Ridge had been forcing North America westward, away from Europe and toward the East Pacific Rise (Figure 2-3b). The Farallon Plate was being slowly subducted beneath North America, and active volcanoes erupted through the Cascades, the California Coast Range, and Baja California. The lofty cones of these old volcanoes were eroded away, and only the roots of the volcanoes are preserved in the deeply eroded mountains. As the Farallon Plate continued to be slowly consumed, the Pacific Plate came into contact with the North America Plate. But the Farallon Plate had been moving eastward, toward the continent, whereas the

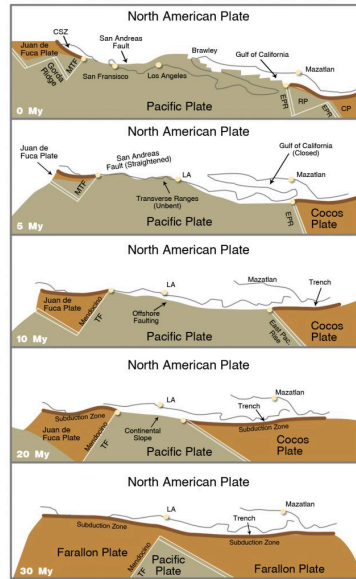

Figure 2-7. At 30 m.y., the oceanic Farallon Plate was subducting under the North America Plate. The double line marks the East Pacific Rise, where the Pacific and Farallon plates were moving apart by sea-floor spreading. The single line at left marks the Mendocino Transform Fault (MTF), which at that time was west of the future location of Los Angeles (LA). The Pacific Plate was moving northwest at the same time that North America was being driven westward by sea-floor spreading on the Mid-Atlantic Ridge. By 20 m.y., the Pacific and North America plates had met at a transform fault at the base of the continental slope.



Pacific Plate was moving northwest, parallel to the continental edge. So, after the plates came into contact, the Pacific Plate moved northwest past North America along a new transform fault at the base of the continental slope, a forerunner to the San Andreas Fault (Figure 2-7, 20 My and 10 My). The Mendocino Triple Junction moved northwest, too, and the San Andreas ancestor grew in length as the former Farallon Plate broke up into the Juan de Fuca Plate off northern California, Oregon, Washington, and Vancouver Island, and the Cocos Plate off Mexico and Central America. Lavas continued to be spewed out in the Pacific Northwest and in Mexico even as they stopped along the transform fault in California.

About 4.5 million years ago, the transform fault shifted inland to its present position within the

*This transform fault widened with time (10 m.y., 5 m.y.) as more and more of the Pacific Plate came into contact with North America. (The Queen Charlotte Fault, off British Columbia and southeast Alaska, is a modern-day example of a transform fault at the base of the continental slope; see Figure 2-3.) The Mendocino Transform Fault moved northward relative to California. Between 5 m.y. and today, the transform fault at the base of the continental slope shifted position inland, slicing off Baja California and part of Alta California as part of the Pacific Plate. Since then, this continental slice has been moving past the rest of North America, accompanied by large earthquakes. The San Andreas Fault is a transform fault because it separates spreading centers at the Gorda and Juan de Fuca ridges from the spreading centers in the Gulf of California and Imperial Valley. CP, Cocos Plate; RP, Rivera Plate.*

continent as the San Andreas Fault, and Baja California broke away from the rest of Mexico, leaving the Gulf of California in its wake. The Gulf of California is an ocean basin in the making, like the Atlantic Ocean one hundred and eighty million years ago, when the Americas were close to Europe and Africa. Baja California began to drift off to the northwest, taking coastal Alta California along with it and leaving new ocean floor in its wake. The deep parts of the Gulf are mini-ocean basins called *spreading centers*. Basalt lava and hot springs are found in them, just as they are in the Mid-Atlantic Ridge and East Pacific Rise. The northernmost spreading center, oddly enough, is in the Imperial Valley, where continental crust is being pulled apart at the same time that, and the gap is being filled by sediments of the Colorado River.

The Juan de Fuca Plate is breaking off the Gorda Plate along the Blanco Transform Fault (Figure 2-4b, 2-7), and the Rivera Plate (RP in the top map of Figure 2-7), part of the former Cocos Plate, has appeared at the mouth of the Gulf of California. Subduction still continues today in the Pacific Northwest and in Mexico south of the Gulf, accompanied by active volcanoes.

Visualization of these examples of plate tectonics stretches the imagination until we recall that this has taken thirty million years, a length of time that overwhelms our ability to understand it. We are forced to put our imagination of natural processes into ultra-high speed, so that lifetimes flash by in a couple of

seconds, and there is a plate-boundary subduction-zone earthquake at Cascadia every fifteen seconds. Even at that rate, the disappearance of the Farallon Plate would seem extraordinarily slow. If you were watching it as you would a movie, bring lots of popcorn.



A video element has been excluded from this version of the text. You can watch it online here:

<https://open.oregonstate.education/earthquakes/?p=41>

---

## *Suggestions for Further Reading*

Atwater, Tanya, 1989, Plate tectonic history of the northeast Pacific and western North America, in Winterer, E., Hussong, D., and Decker, R., eds., *The Eastern Pacific Ocean and Hawaii: Geological Society of America Decade of North American Geology v. N*, p. 21-72.

Glen, W., 1982. *The Road to Jaramillo*. Stanford, CA: Stanford University Press. An account of the plate tectonics revolution.

Kearey, P., and F. J. Vine. 1990. *Global Tectonics*. London: Blackwell Scientific Publications, 302 p.

Kious, W. J., and R. I. Tilling. 1996. *This Dynamic Earth*:

the Story of Plate Tectonics: U.S. Geological Survey.  
Out of print, but on the web at

[http://pubs.usgs.gov/publications/text/  
dynamic.html](http://pubs.usgs.gov/publications/text/dynamic.html)

Lillie, R. J. 1999. Whole-Earth Geophysics. Englewood  
Cliffs, N.J.: Prentice-Hall, 361 p.

# 3. Earthquake Basics

## 1. Introduction

The problem is that earthquakes start out many miles beneath the surface, too deep for us to observe them directly. So we study them from afar by (1) observing the geological changes at the ground surface, (2) analyzing the symphony of earthquake vibrations recorded on seismographs, and (3) monitoring the tectonic changes in the Earth's crust by surveying it repeatedly, using land survey techniques for many years and now using satellites. In addition, we have laboratory experimental results on how rocks behave at the depths and temperatures where earthquakes form, which helps us understand what happens during an earthquake. One of the important things to recognize is that rocks, like rubber bands, are elastic.

## 2. Elastic Rocks: How They Bend and Break

---



A video element has been excluded from this version of the text. You can watch it online here:

<https://open.oregonstate.education/earthquakes/?p=65>

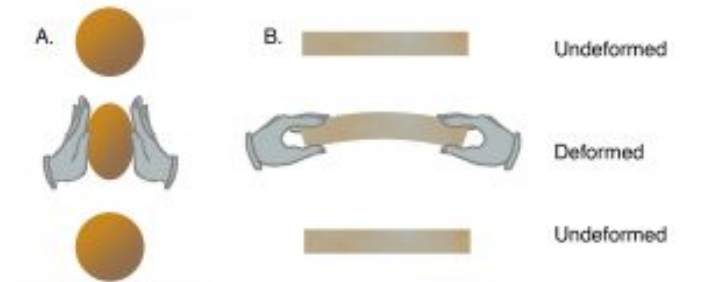

Figure 3-1. Elasticity. (a) An inflated balloon is squeezed between two hands, changing its shape. If the hands are removed, the balloon returns to its earlier shape. (b) A thin board is bent into a curved shape. If the hands bending the board are removed, the board returns to its original shape. The balloon and board are both elastic.

---



A video element has been excluded from this version of the text. You can watch it online here:

<https://open.oregonstate.edu/earthquakes/?p=65>

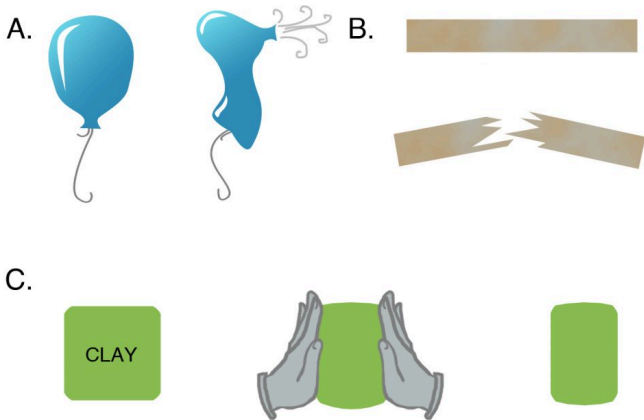

Figure 3-2. (a) When the balloon is squeezed too hard, it pops. (b) When the board is bent too much, it breaks. These are examples of brittle fracture. (c) When a piece of bubble gum or Silly Putty is squeezed between two hands, it deforms. When the hands are removed, it stays in the same deformed shape. This is called ductile deformation.

If you blow up a balloon, the addition of air causes the balloon to expand. If you then squeeze the balloon with your hands (Figure 3-1, left), the balloon will change its shape. Removing your hands causes the balloon to

return to its former shape (Figure 3-1, left). If you take a thin board and bend it with your hands (Figure 3-1, right), the board will deform. If you let the board go, it will straighten out again. These are examples of a property of solids called *elasticity*. When air is blown into the balloon, or when the balloon is squeezed, or when the board is bent, strain energy is stored up inside the rubber walls of the balloon and within the board. When the balloon is released, or the board is let go, the strain energy is released as balloon and board return to their former shapes.

But if the balloon is blown up even further, it finally reaches a point where it can hold no more air, and it bursts (Figure 3-2, upper left). The strain energy is released in this case, too, but it is released abruptly, with a pop. Instead of returning to its former size, the balloon breaks into tattered fragments. In the same way, if the small board is bent too far, it breaks with a snap as the strain energy is released (Figure 3-2, upper right).

It is not so easy to picture rocks as being elastic, but they are. If a rock is squeezed in a laboratory rock press, it behaves like a rubber ball, changing its shape slightly. When the pressure of the rock press is released, the rock returns to its former shape, just as the balloon or the board does, as shown in Figure 3-1. But if the rock press continues to bear down on the rock with greater force, ultimately the rock will break, like the balloon or the board in Figure 3-2.

This elastic behavior is characteristic of most rocks



in the brittle crust, shallower than the brittle-ductile transition, as shown in Figure 2-1. Rocks at greater depths commonly do not break by brittle fracture but deform like bubble gum or like the geologist's favorite toy, Silly Putty. When a piece of Silly Putty is squeezed together, it deforms permanently; it does not return to its original shape after the squeezing hands are removed (Figure 3-2, bottom).



A video element has been excluded from this version of the text. You can watch it online here:

<https://open.oregonstate.education/earthquakes/?p=65>

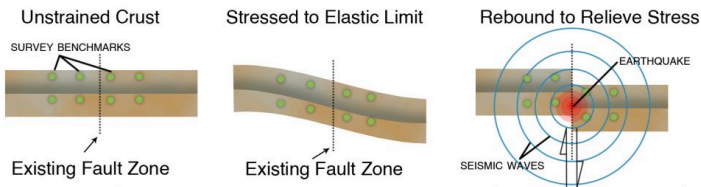

Figure 3-3. Illustration of elastic rebound theory of Harry F. Reid. Strain is building up.



A video element has been excluded from this version of the text. You can watch it online here:

<https://open.oregonstate.education/earthquakes/?p=65>

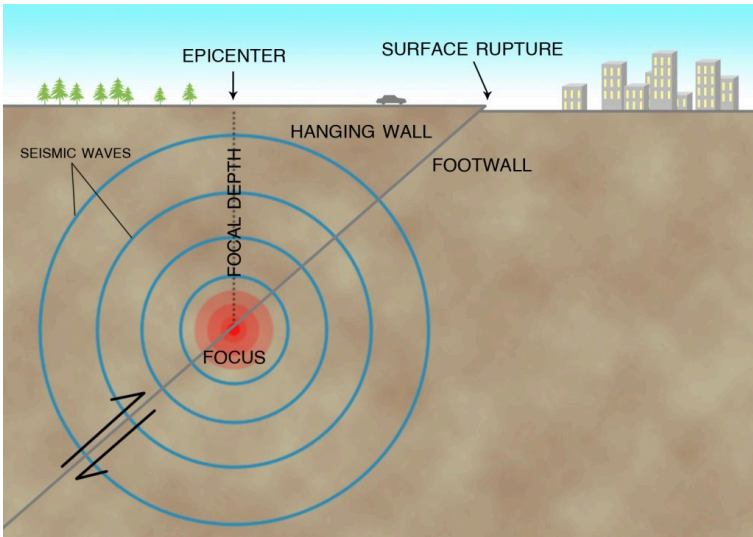

Figure 3-4. A cross section of the Earth's crust.

After the great San Francisco Earthquake of 1906 on the San Andreas Fault, Professor Harry F. Reid of Johns Hopkins University, a member of Andrew Lawson's State Earthquake Investigation Commission, compared two nineteenth-century land surveys on both sides of the fault (Figure 3-3, left and center) with a new survey taken just after the earthquake (Figure 3-3, right). These survey comparisons showed that widely separated survey benchmarks on opposite sides of the fault had moved more than 10 feet (3.2 meters) with respect to each other even *before* the earthquake, and this slow movement was in the same direction as the sudden movement *during* the earthquake. Based on

these observations, Reid proposed his *elastic rebound theory*, which states that the Earth's crust acts like the bent board mentioned earlier. Strain accumulates in the crust until it causes the crust to rupture in an earthquake, like the breaking of the board and the bursting of the balloon.

Another half-century would pass before we would understand *why* the strain had built up in the brittle crust before the San Francisco Earthquake. We know now that it is due to plate tectonics. The Pacific Plate is slowly grinding past the North America Plate along the San Andreas Fault. But the San Andreas Fault, where the two plates are in contact, is stuck, and so the crust deforms elastically, like bending the board. The break is along the San Andreas Fault because it is relatively weak compared to other parts of the two plates that have not been broken repeatedly. A section of the fault that is slightly weaker than other sections gives way first, releasing the plate-tectonic strain as an earthquake.

If we knew the crustal strengths of various faults, and if we also knew the exact rate at which strain is building up in the crust at these faults, we could then forecast when the next earthquake would strike, an idea that occurred to Harry Reid. We are beginning to understand the rate at which strain builds up on a few of our most hazardous faults, like the San Andreas Fault. But we have very little confidence in our knowledge of the crustal strength that must be overcome to produce an earthquake. The crust is stronger in some places along the fault than others, and crustal strengths are

probably different on the same part of a fault at different times in its history. This makes it difficult to forecast when the next earthquake will strike the San Andreas Fault, even though we know more about its earthquake history than any other fault on Earth.



*Figure 3-5a. Right-lateral strike-slip fault. Aerial view of San Andreas Fault in Carrizo Plain, California. Fault is marked by a linear zone that can be traced from left to right across photo. Two streams crossing the fault have been deflected to right. The most recent rupture was during the Fort Tejon Earthquake of 1857. Photo credit: University of Colorado, as reproduced in NASA Natural Hazards Slide Set: Earthquakes in Southern California 1979-1989. Photo by USGS*

### 3. A Classification of Faults

Most damaging earthquakes form on faults at a depth of five miles or more in the Earth's crust, too deep to be observed directly. But most of these faults are also exposed at the surface where they may be studied by geologists. Larger earthquakes may be accompanied by surface movement on these faults, damaging or destroying human-made structures under which they pass.



Figure 3-5b. Right-lateral strike-slip fault. Offset furrows in a cultivated field near El Centro, California, during an earthquake on October 15, 1979.

Some faults are vertical, so that an earthquake at 10 miles depth is directly beneath the fault at the surface where rupture of the ground can be observed. Other faults dip at a low angle, so that the fault at the surface may be several miles away from the point on the Earth's surface directly above the earthquake (Figure 3-4). Where the fault has a low dip or inclination, the rock above the fault is called the *hanging wall*, and the rock below the fault is called the *footwall*. These are terms that were first coined by miners and prospectors.

Valuable ore deposits are commonly found in fault zones, and miners working underground along a fault zone find themselves standing on the footwall, with the hanging wall over their heads.

If the hanging wall moves up or down during an earthquake, the fault is called a *dip-slip fault* (Figure 3-4). If the hanging wall moves sideways, parallel with the Earth's surface, as shown in Figure 3-3, 3-5, and 3-6, the fault is called a *strike-slip fault*.

There are two kinds of strike-slip fault, *right-lateral* and *left-lateral*. If you stand on one side of a right-lateral fault, objects on the other side of the fault appear to move to your right during an earthquake (Figure 3-5a, b). The San Andreas Fault is the world's best-known example of a right-lateral fault (Figure 3-5a). At a left-lateral fault, objects on the other side of the fault appear to move to your left (Figure 3-6). Some of the faults off the coast of Oregon and Washington are left-lateral faults (Figure 4-1, following chapter).



*Figure 3-6. Road displaced to the left during an earthquake in 1990 on a left-lateral strike-slip fault on the Island of Luzon in the Philippines.*



Figure 3-7. Normal fault scarp at margin of Pleasant Valley, south of Winnemucca, Nevada, formed suddenly during an earthquake in 1915 raising the hills on the left with respect to the terrain on the right. Fault dips (slopes) toward the right. Truck is parked on hanging wall of fault; left skyline is part of footwall. Photo by Robert Wallace, USGS

If the hanging wall of a dip-slip fault moves down with respect to the footwall, it is called a *normal fault* (Figure 3-7). This happens when the crust is being pulled apart, as in the case of faults bordering Steens Mountain in southeastern Oregon, or at sea-floor spreading centers. If the hanging wall moves up with respect to the footwall, it is called a *reverse fault* (Figure 3-8). This happens when the crust is jammed together. The Cascadia Subduction Zone, where the Juan de Fuca and Gorda oceanic plates are driving beneath the continent,



is a very large-scale example of a reverse fault. The 1971 Sylmar Earthquake ruptured the San Fernando Reverse Fault, buckling sidewalks and raising the ground, as shown in Figure 3-8a. The 1999 Chi-Chi, Taiwan, Earthquake was accompanied by surface rupture on a reverse fault, including the rupture across a running track at a high school (Figure 3-8b). The Seattle Fault, extending east-west through downtown Seattle, is a reverse fault. Where the dip of a reverse fault is very low, it is called a *thrust fault*.



Figure 3-8a. Reverse fault in the San Fernando Valley, California, formed during the Sylmar Earthquake of February 9, 1971. Fault extends from left to right. Buckling of sidewalk indicates compression; fault dips away from viewer. Hanging wall (in background) was at same level as footwall (in foreground) before the earthquake. Ruined building in left background was part of a convalescent home in which several people died.



*Figure 3-8b. Reverse fault across a running track at Kuangfu High School in central Taiwan, formed by Chelungpu reverse fault during Chi-Chi earthquake. Photo by Robert Yeats for both 3-8 a and b.*

The 1983 Coalinga Earthquake in the central Coast Ranges and the 1994 Northridge Earthquake in the San Fernando Valley, both in California, were caused by rupture on reverse faults, but these faults did not reach the surface. Reverse faults that do not reach the surface are called *blind faults*, and if they have low dips, they



Figure 3-9. Ventura Avenue Anticline in oil field north of Ventura, California. Folded rock layers were formerly horizontal, deposited on the floor of the ocean. Folding is controlled by displacement on a deeply buried reverse fault called a *blind thrust*.

are called *blind thrusts*. In many cases, such faults are expressed at the Earth's surface as folds in rock. An upward fold in rock is called an *anticline*(Figure 3-9), and a downward fold is called *syncline*. Before these two earthquakes, geologists thought that anticlines and synclines form slowly and gradually and are not related to earthquakes. Now it is known that they may hide blind faults that are the sources of earthquakes. Such folds cover blind faults in the linear ridges in the Yakima Valley of eastern Washington.

Figure 3-10a is a summary diagram showing the four types of faults that produce earthquakes: left-lateral strike-slip fault, right-lateral strike-slip fault, normal fault, and reverse fault. Figure 2-10b shows a blind reverse fault, the special type of reverse fault that does

not reach the surface but is manifested at the surface as an anticline or a warp.



A video element has been excluded from this version of the text. You can watch it online here:

<https://open.oregonstate.edu/earthquakes/?p=65>

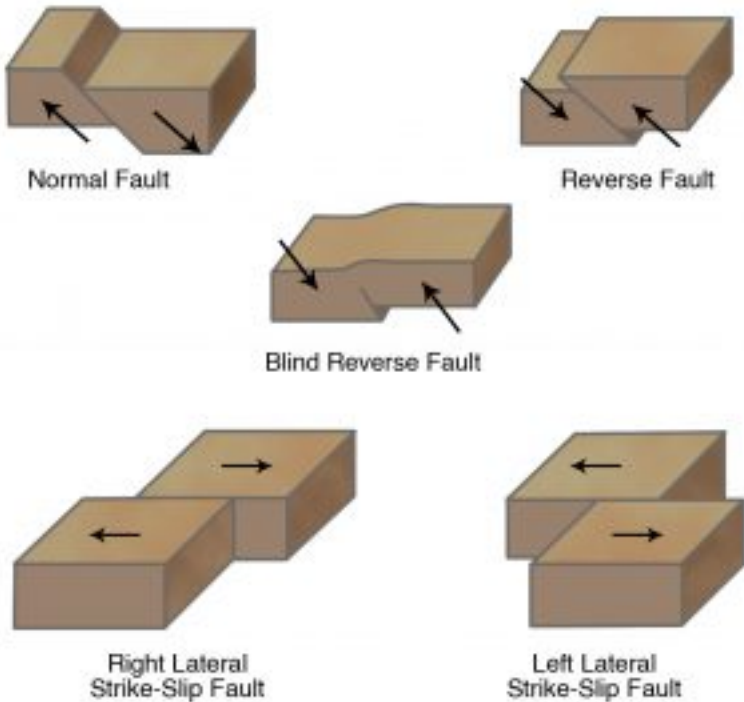

Figure 3-10a. A classification of faults. Top, dip-slip faults. Left, normal fault. Right, reverse fault. Middle, left-lateral and right-lateral strike-slip faults. Bottom, oblique-slip fault, with a component of dip slip and strike slip.

Figure 3-10a. A classification of faults. Top, dip-slip faults. Left, normal fault. Right, reverse fault. Middle, left-lateral and right-lateral strike-slip faults. Bottom, oblique-slip fault, with a component of dip slip and strike slip.

## 4. Paleoseismology: Slip Rates and Earthquake Recurrence Intervals

Major earthquakes are generally followed by aftershocks, some large enough to cause damage and loss of life on their own. The aftershocks are part of the earthquake that just struck, like echoes, but last for months and even years. But if you have just suffered through an earthquake, the aftershocks may cause you to ask: when will the next earthquake strike? I now restate this question: when will the next large earthquake (as opposed to an aftershock) strike *the same section of fault*?

The San Fernando Valley in southern California had an earthquake in 1994, twenty-three years after it last experienced one in 1971. But these earthquakes were on different faults: the 1971 earthquake had surface rupture, the 1994 earthquakes did not. That is not the question I ask here. To answer my question, the geologist tries to determine the *slip rate*, the rate at which one side of a fault moves past the other side over many thousands of years and many earthquakes. This is done by identifying and then determining the age of a feature like a river channel that was once continuous across the fault but is now offset by it, like the examples in Figure 3-5a.

It is also necessary for us to identify and determine the ages of earthquakes that struck prior to our recorded history, a science called *paleoseismology*. For

example, in central California, Wallace Creek is offset 420 feet (130 meters) across the San Andreas Fault. Sediments deposited in the channel of Wallace Creek prior to its offset are 3,700 years old, based on radiocarbon dating of charcoal in the deposits. The slip rate is the amount of the offset, 420 feet, divided by the age of the channel that is offset, 3,700 years, a little less than 1.4 inches (35 millimeters) per year.

Wallace Creek crosses that part of the San Andreas Fault where strike-slip offset during the great Fort Tejon Earthquake of 1857 was 30-40 feet. How long would it take for the fault to build up as much strain as it released in 1857? To find out, divide the 1857 slip, 30-40 feet, by the slip rate, 1.4 inches per year, to get 260 to 340 years, which is an estimate of the *average earthquake recurrence interval* for this part of the fault. (I round off the numbers because the age of the offset Wallace Creek, based on radiocarbon dating, and the amount of its offset are not precisely known.) Paleoseismologic investigation of backhoe trench excavations shows that the last earthquake to strike this part of the fault prior to 1857 was around the year 1480, an interval of 370 to 380 years, which agrees with our calculations within our uncertainty of measurement. This is reassuring because the lowest estimate of the recurrence interval, 260 years, won't end until after the year 2100.

Crustal faults in the Pacific Northwest have much slower slip rates, and so the earthquake recurrence times are much longer. Say that we learned that a

reverse fault has a slip rate of 1/25 inch (1 millimeter) per year, and we conclude from a backhoe trench excavation across the fault that an earthquake on the fault will cause it to move 10 feet (120 inches). The return time would be three thousand years. Could we use that information to forecast when the next earthquake would occur on that fault?

Unfortunately, this question is not easy to answer because the faults and the earthquakes they produce are not very orderly. For example, the 1812 and 1857 earthquakes on the same section of the San Andreas Fault ruptured different lengths of the fault, and their offsets were different. Displacements on the same fault during the same earthquake differ from one end of the rupture to the other. The recurrence intervals differ as well. We were reassured by the recurrence interval of 370 to 380 years between the 1857 earthquake and a prehistoric event around A.D. 1480, but the earthquake prior to A.D. 1480 struck around A.D. 1350, a recurrence interval of only 130 years. For a fault with an average recurrence interval of three thousand years, the irregularity in return times could be more than a thousand years, so that the average recurrence interval would have little value in forecasting the time of the next earthquake on that section of fault.

We can give a statistical likelihood of an earthquake striking a given part of the San Andreas Fault in a certain time interval after the last earthquake (see Chapter 7), but we can't nail this down any closer because of the poorly understood variability in strength



of fault zones, variability in time as well as position on the fault. Another difficulty is in our use of radiocarbon dating to establish the timing of earlier earthquakes. Charcoal may be rare in the faulted sediments we are studying. And radiocarbon doesn't actually date an earthquake. It dates the youngest sediments cut by a fault and the oldest unfaulted sediments overlying the fault, assuming that these sediments have charcoal suitable for dating.

## 5. What Happens During an Earthquake?

Crustal earthquakes start at depths of five to twelve miles, typically in that layer of the Earth's crust that is strongest due to burial pressure, just above the brittle-ductile transition, the depth below which temperature weakening starts to take effect (Figure 2-1). Slab earthquakes like the Nisqually Earthquake of 2001 start in the Juan de Fuca Plate underlying the continent, at greater depths but still in brittle rock. These depths are too great for us to study the source areas of earthquakes directly by deep drilling, and so we have to base our understanding on indirect evidence. We do this by studying the detailed properties of seismic waves that pass through these crustal layers, or by subjecting rocks to laboratory tests at temperatures

and pressures expected at those depths. And some ancient fault zones have been uplifted and eroded in the millions of years since faulting took place, allowing us to observe them directly at the surface and make inferences on how ancient earthquakes may have occurred on them.



A video element has been excluded from this version of the text. You can watch it online here:

<https://open.oregonstate.education/earthquakes/?p=65>

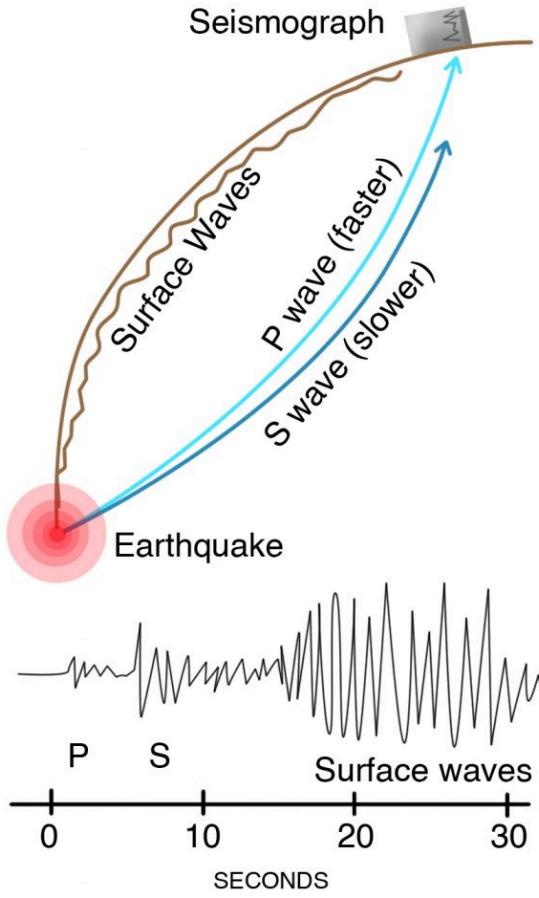

Figure 3-11. An earthquake produces P waves, or compressional waves, that travel faster and reach the seismograph first, and S waves, or shear waves, that are slower. Both are transmitted within the Earth and are called body waves. Even slower are surface waves that run along the surface of the earth and do a lot of the

*damage. The earthquake focus is the point within the Earth where the earthquake originates. The epicenter is a point on the surface directly above the focus. The diagram below is a seismogram, reading from left to right, showing that the P wave arrives first, followed by the S wave and then by surface waves.*

---

An earthquake is most likely to rupture the crust where it previously has been broken at a fault, because a fault zone tends to be weaker than unfaulted rock around it. The Earth's crust is like a chain, only as strong as its weakest link. Strain has been building up elastically, and now the strength of the faulted crust directly above the zone where temperature weakening occurs is reached. Suddenly, this strong layer fails, and the rupture races sideways and upward toward the surface, breaking the weaker layers above it, and even downward into crust that would normally behave in a ductile manner. The motion in the brittle crust produces friction, which generates heat that may be sufficient to melt the rock in places. In cases where the rupture only extends for a mile or so, the earthquake is a relatively minor one, like the 1993 Scotts Mills Earthquake east of Salem, Oregon. But in rare instances, the rupture keeps going for hundreds of miles, and a great earthquake like the 1906 San Francisco Earthquake or the 2002 Denali, Alaska, Earthquake is the result. At present, scientists can't say why one earthquake stops after only a small

segment of a fault ruptures, but another segment of fault ruptures for hundreds of miles, generating a giant earthquake.

The rupture causes the sudden loss of strain energy that the rock had built up over hundreds of years, equivalent to the snap of the board or the pop of the balloon. The shock radiates out from the rupture as seismic waves, which travel to the surface and produce the shaking we experience in an earthquake (Figure 3-11). These waves are of three basic types: *P waves* (primary waves), *S waves* (secondary or shear waves), and *surface waves*. P and S waves are called *body waves* because they pass directly through the Earth, whereas surface waves travel along the Earth's surface, like the ripples in a pond when a stone is thrown into it.

P and S waves are fundamentally different (Figure 3-12). A P wave is easily understood by a pool player, who “breaks” a set of pool balls arranged in a tight triangle, all touching. When the cue ball hits the other balls, the energy of striking momentarily compresses the next ball elastically. The compression is transferred to the next ball, then to the next, until the entire set of pool balls scatters around the table. The elastic deformation is parallel to the direction the wave is traveling, as shown by the top diagram in Figure 3-12. P waves pass through a solid, like rock, and they can also pass through water or air. When earthquake waves pass through air, sometimes they produce a noise.

An S wave can be imagined by tying one end of a rope to a tree. Hold the rope tight and shake it rapidly

from side to side. You can see what looks like waves running down the rope toward the tree, distorting the shape of the rope. In the same fashion, when S waves pass through rock, they distort its shape. The elastic deformation is at right angles to the direction the wave travels, as shown by the bottom diagram in Figure 3-12. S waves cannot pass through liquid or air, and they would not be felt aboard a ship at sea.



A video element has been excluded from this version of the text. You can watch it online here:

<https://open.oregonstate.education/earthquakes/?p=65>



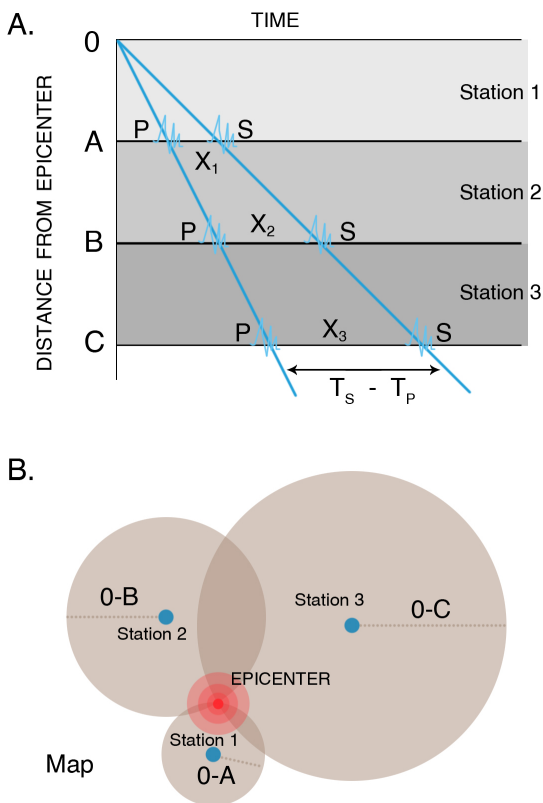

Figure 3-12. Two views of (a) P waves and (b) S waves, all moving from left to right. A P wave moves by alternately compressing and dilating the material through which it passes, somewhat analogous to stop-and-go traffic on the freeway during rush hour. An S wave moves by shearing the material from side to side, analogous to flipping a rope tied to a tree. Note the illustration of wavelength for P and S waves and amplitude for S waves. The number of complete wavelengths to pass a point in a second is the frequency.

Because S waves are produced by sideways motion, they are slower than P waves, and the seismologist uses this fact to tell how far it is from the seismograph to the earthquake (Figure 3-13). The seismogram records the P wave first, then the S wave. If the seismologist knows the speed of each wave, then by knowing that both waves started at the same time, it is possible to work out how far the earthquake waves have traveled to reach the seismograph. If we can determine the distance of the same earthquake from several different seismograph stations, we are able to locate the *epicenter*, which is the point on the Earth's surface directly above the earthquake *focus*. The focus or *hypocenter* is the point beneath the Earth's surface where the crust or mantle first ruptures to cause an earthquake (Figure 3-4). The depth of the earthquake below the surface is called its *focal depth*.

A modern three-component seismograph station provides more information about an earthquake source than a single-component seismograph because it consists of three separate seismometers, one measuring motion in an east-west direction, one measuring north-south motion, and one measuring up-down motion. An east-west seismometer, for example, can tell if the wave is coming from an easterly or westerly direction, and a seismograph in Seattle could distinguish an earthquake on the Cascadia Subduction Zone to the west from an earthquake in the Pasco Basin east of the Cascades.

The surface waves are more complex. After reaching

the surface, much earthquake energy will run along the surface, causing the ground to go up and down, or sway from side to side. Some people caught in an earthquake have reported that they could actually see the ground moving up and down, like an ocean wave, but faster.

An earthquake releases a complex array of waves, with great variation in *frequency*, which is the number of waves to pass a point in a second. A guitar string vibrates many times per second, but it takes successive ocean waves many seconds to reach a waiting surfer. The ocean wave has a low frequency, and the guitar string vibrates at a high frequency. An earthquake can be compared to a symphony orchestra, with cellos, bassoons, and bass drums producing sound waves that vibrate at low frequencies, and piccolos, flutes, and violins that vibrate at high frequencies. It is only by use of high-speed computers that a seismologist can separate out the complex vibrations produced by an earthquake and begin to read and understand the music of the spheres.



A video element has been excluded from this version of the text. You can watch it online here:

<https://open.oregonstate.education/earthquakes/?p=65>

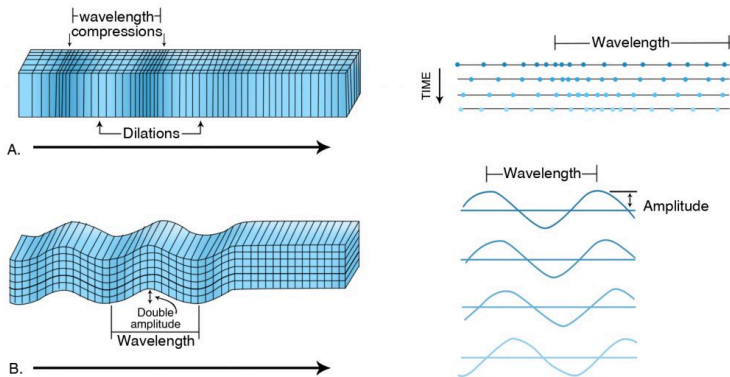

Figure 3-12. Two views of (a) P waves and (b) S waves, all moving from left to right. A P wave moves by alternately compressing and dilating the material through which it passes, somewhat analogous to stop-and-go traffic on the freeway during rush hour. An S wave moves by shearing the material from side to side, analogous to flipping a rope tied to a tree. Note the illustration of wavelength for P and S waves and amplitude for S waves. The number of complete wavelengths to pass a point in a second is the frequency. Low-frequency body waves of large earthquakes travel on a curving path through the Earth for thousands of miles to reach seismographs around the world (Figure 3-11). I pointed out earlier that only the outermost parts of the Earth are elastic. How can the mantle, which is capable of the slow plastic flow that drives plate tectonics, also behave as an elastic solid when earthquake body waves pass through it?

To explain this, I return to my piece of Silly Putty (Figure 3-2). Silly Putty can be stretched out like bubble gum when it is pulled slowly. Hang a piece of Silly Putty over the side of a table, and it will slowly drip to the floor under its own weight, like soft tar (ductile flow).

Yet it has another, seemingly contradictory, property when it is deformed rapidly. It will bounce like a ball, indicating that it can be elastic. If Silly Putty is stretched out suddenly, it will break, sometimes into several pieces (brittle fracture).

The difference is whether the strain is applied suddenly or slowly. When strain is applied quickly, Silly Putty will absorb strain elastically (it will bounce), or it will shatter, depending on whether the strain takes it past its breaking point. Earthquake waves deform rock very quickly, and like Silly Putty, the rock behaves like an elastic solid. If strain is applied slowly, Silly Putty flows, almost like tar. This is the way the asthenosphere and lower crust work. The internal currents that drive the motion of plate tectonics are extremely slow, inches per year or less, and at those slow rates, rock flows.

Furthermore, when a fault ruptures the brittle crust just above the brittle-ductile transition, the fault rupture may propagate downward into crust that behaves in a brittle fashion because the fault rupture is generated at high speed, in contrast to its response to the slow deformation of plate tectonics. We will return to this subject in Chapter 4, where we consider the behavior of the Cascadia Subduction Zone, in which the plate boundary consists of material closer to the surface that is elastic or subject to brittle fracture under all conditions, a deeper layer that is ductile under all conditions, and an intermediate, or transitional, layer that is ductile when stress is applied slowly, at the rates of plate tectonics, but is brittle when stress

is applied rapidly as an earthquake-generating fault propagates downward. But even the deepest layer is elastic to the propagation of seismic body waves.

## 6. Measuring an Earthquake

### a. Magnitude

The chorus of high-frequency and low-frequency seismic waves that radiate out from an earthquake indicates that no single number can characterize an earthquake, just as no single number can be used to describe a Yakima Valley wine or a sunset view of Mt. Rainier or Mt. Hood.

The size of an earthquake was once measured largely on the basis of how much damage was done. This was unsatisfactory to Caltech seismologist Charles Richter, who wanted a more quantitative measure of earthquake size, at least for southern California. Following up on earlier work done by the Japanese, Richter in 1935 established a *magnitude* scale based on how much a seismograph needle is deflected by a seismic wave generated by an earthquake about sixty miles (a hundred kilometers) away (Figure 3-14). Richter used a seismograph specially designed by seismologist Harry Wood and astronomer John Anderson to record local

earthquakes in southern California. This seismograph was best suited for those waves that vibrated with a frequency of about five times per second, which is a bit like measuring how loud an orchestra is by how loud it plays middle C. Nonetheless, it enabled Richter and his colleagues to distinguish large, medium-sized, and small earthquakes in California, which was all they wanted to do. Anderson was an astronomer, and the seismograph was built at the Mt. Wilson Observatory, which may account for the word *magnitude*, a word that also expresses how bright a star is.

Complicating the problem for the lay person is that Richter's scale is logarithmic, which means that an earthquake of magnitude 5 would deflect the needle of the Wood-Anderson seismograph ten times more than an earthquake of magnitude 4 (Figure 3-14). And an increase of one magnitude unit represents about a thirty-fold increase in release of stored-up seismic strain energy. So the Olympia, Washington, Earthquake of 7.1 on April 13, 1949, would be considered to have released the energy of more than thirty earthquakes the size of the Klamath Falls, Oregon, Earthquake of September 20, 1993, which was magnitude 6.



A video element has been excluded from this version of the text. You can watch it online here:

<https://open.oregonstate.education/earthquakes/?p=65>

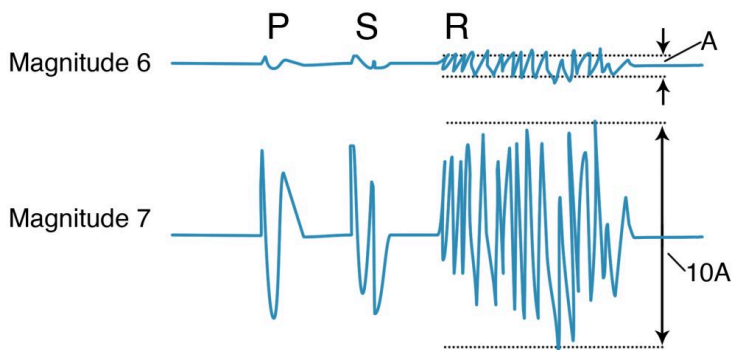

Figure 3-14. Richter's concept of magnitude. The delay between the P wave and the S wave is the same in both seismograms, so the two earthquakes are the same distance from the seismograph. The larger magnitude has a greater amplitude of deflection of the seismic waves. Richter used those earthquake waves with a frequency of about five wavelengths per second. In the figure, A is twice the amplitude. The magnitude 7 earthquake has a value of A ten times that of the magnitude 6 earthquake.

Richter never claimed that his magnitude scale, now called *local magnitude* and labeled ML, was an accurate measure of earthquakes. Nonetheless, the Richter magnitude scale caught on with the media and the general public, and it is still the first thing that a reporter asks a professional about an earthquake: “How big was it on the Richter scale?” The Richter magnitude scale works reasonably well for small to moderate-size earthquakes, but it works poorly for very large earthquakes, the ones we call great earthquakes. For these, other magnitude scales are necessary.

To record earthquakes at seismographs thousands of



miles away, seismologists had to use long-period (low-frequency) waves, because the high-frequency waves recorded by Richter on the Wood-Anderson seismographs die out a few hundred miles away from the epicenter. To understand this problem, think about how heavy metal music is heard a long distance away from its source, a live band or a boom box. Sometimes when my window is open on a summer evening, I can hear a faraway boom box in a passing car, but all I can hear are the very deep, or low-frequency, tones of the bass guitar, which transmit through the air more efficiently than the treble (high-frequency) guitar notes or the voices of the singers. In this same way, low-frequency earthquake waves can be recorded thousands of miles away from the earthquake source, so that we were able to record the magnitude 9 Tohoku-oki earthquake in Japan on our seismograph in Corvallis, Oregon. Low-frequency body waves pass through the Earth and are used to study its internal structure, analogous to X-rays of the human body. A body-wave magnitude is called  $m_b$ .

A commonly used earthquake scale is the *surface wave magnitude scale*, or MS, which measures the largest deflection of the needle on the seismograph for a surface wave that takes about twenty seconds to pass a point (which is about the same frequency as some ocean waves).

The magnitude scale most useful to professionals is the *moment magnitude scale*, or MW, which comes closest to measuring the true size of an earthquake,

particularly a large one. This scale relates magnitude to the area of the fault that ruptures and the amount of slip that takes place on the fault. For many very large earthquakes, this can be done by measuring the length of the fault that ruptures at the surface and figuring out how deep the zone of aftershocks extends, thereby calculating the area of the rupture. The amount of slip can be measured at the surface as well. The seismologist can also measure MW by studying the characteristics of low-frequency seismic waves, and the surveyor or geodesist (see section 7 of this chapter) can measure it by remeasuring the relative displacement of survey benchmarks immediately after an earthquake to work out the distortion of the ground surface and envisioning a subsurface fault that would produce the observed distortion (see below).

For small- to intermediate-size earthquakes, the magnitude scales are designed so that there is relatively little difference between Richter magnitude, surface-wave magnitude, and moment magnitude. But for very large earthquakes, the difference is dramatic. For example, both the 1906 San Francisco Earthquake and the 1964 Alaska Earthquake had a surface-wave magnitude of 8.3. However, the San Francisco Earthquake had a moment magnitude of only 7.9, whereas the Alaska Earthquake had a moment magnitude of 9.2, which made it the second-largest earthquake of the twentieth century. The surface area of the fault rupture in the Alaska Earthquake was the size of the state of Iowa!

## b. Intensity

Measuring the size of an earthquake by the energy it releases is all well and good, but it is still important to measure how much damage it does at critical places (such as where you or I or our loved ones happen to be when the earthquake strikes). This measurement is called earthquake *intensity*, which is measured by a Roman numeral scale (Table 3-1). Intensity III means no damage, and not everybody feels it. Intensity VII or VIII involves moderate damage, particularly to poorly constructed buildings, while Intensity IX or X causes considerable damage. Intensity XI or XII, which fortunately is rare, is characterized by nearly total destruction.

Earthquake intensities are based on a post-earthquake survey of a large area. Damage is noted, and people are questioned about what they felt. An intensity map is a series of concentric lines, irregular rather than circular, in which the highest intensities are generally (but not always) closest to the epicenter of the earthquake. For illustration, an intensity map is shown for the 1993 Scotts Mills Earthquake in the Willamette Valley of Oregon (Figure 3-15). High intensities were recorded near the epicenter, as expected. But intensity can also be influenced by the characteristics of the ground. Buildings on solid rock tend to fare better (and thus are subjected to lower intensities) than buildings on thick soft soil. The Intensity VI contour bulges out

around the capital city of Salem, and the Intensity V contour bends south to include the city of Albany. Both are along the Willamette River (dotted line in Figure 3-15), where soft river deposits increased strong shaking. The effect of soft soils is discussed further in Chapter 8.

---

## Modified Mercalli Intensity Scale

---

### I

Not felt except by a very few, under especially favorable circumstances.

### II

Felt only by a few persons at rest, especially on upper floors of buildings. Delicately suspended objects may swing.

### III

Felt quite noticeably indoors, especially on upper floors of buildings, but many people do not recognize it as an earthquake. Standing automobiles may rock slightly. Vibrations like the passing of a truck.

### IV

During the day, felt indoors by many, outdoors by few. At night, some awakened. Dishes, windows, doors disturbed; walls make creaking sound. Sensation like heavy truck striking building. Standing automobiles rocked noticeably.

### V

Felt by nearly everyone; many awakened. Some dishes, windows, etc. broken; cracked plaster in a few places; unstable objects overturned. Disturbance of trees, poles, and other tall objects sometimes noticed. Pendulum clocks may stop.

**Figure 3-15. Intensity map of the March 25, 1993, Scotts Mills Earthquake. The star marks the epicenter. If you felt this earthquake, find your location on the map, note the intensity, and compare your own observations with those expected with the intensity shown in Table 3-1. (1 km = 0.62 miles) From Gerald Black, Oregon Department of Geology and Mineral Industries.**

## VI

Felt by all, many frightened and run outdoors. Some heavy furniture moved; a few instances of fallen plaster and damaged chimneys. Damage slight; masonry D cracked.

## VII

Everybody runs outdoors. Damage negligible in buildings of good design and construction; slight to moderate in well-built ordinary structures; considerable in poorly built or badly designed structures (masonry D); some chimneys broken. Noticed by persons driving cars.

## VIII

Damage slight in specially designed structure; no damage to masonry A, some damage to masonry B, considerable damage to masonry C with partial collapse. panel walls thrown out of frame structures. Fall of chimneys, factory stacks, columns, monuments, walls. Frame houses moved off foundations if not bolted. Heavy furniture overturned. Sand and mud ejected in small amounts. Changes in well water. Persons driving cars disturbed.

## IX

Damage considerable in specially designed structures; well-designed frame structures thrown out of plumb; great in substantial buildings, with partial collapse. Masonry B seriously damaged, masonry C heavily damaged, some with partial collapse, Masonry D destroyed. Buildings shifted off foundations.  
Ground cracked conspicuously. Underground pipes broken.

## X

Some well-built wooden structures destroyed; most masonry and frame structures destroyed with foundations; ground badly cracked. Rails bent. Landslides considerable from river banks and steep slopes.  
Shifted sand and mud. Water splashed over banks.

## XI

Few, if any, masonry structures remain standing. Bridges destroyed. Broad fissures in ground. Underground pipelines completely out of service.

Earth slumps and land slips in soft ground. Rails bent greatly.

## XII

Damage total. Waves seen on ground surface. Lines of sight and level distorted. Objects thrown into the air.

### **Masonry A**

Good workmanship, mortar, and design; reinforced, especially laterally, and bolted together using steel, concrete, etc.

#### **Masonry B**

Good workmanship and mortar, reinforced, but not designed in detail to resist lateral forces.

#### **Masonry C**

Ordinary workmanship and mortar, no extreme weakness like failing to tie in at corners, but neither reinforced nor designed against horizontal forces.

#### **Masonry D**

Weak materials such as adobe; poor mortar, low standards of workmanship, weak horizontally.

---

In the Pacific Northwest, creating an intensity map by the use of questionnaires is now done on the Internet. You can contribute to science. If you feel an earthquake, go to <http://www.ess.washington.edu> and click on Pacific Northwest Earthquakes, which will take you to the Pacific Northwest Seismograph Network. Click on Report an Earthquake. This brings up the phrase, *Did*

*You Feel It?* Click on your state and you can fill out a report and submit it electronically. The resulting map shows intensity in color, by zip code, and is called the Community Internet Intensity Map (CIIM). Figure 3-16 shows the CIIM for the 2001 Nisqually Earthquake. An earthquake of M 3.7 near Bremerton, Washington, on May 29, 2003, drew more than one thousand responses in the first twenty-four hours.

Figure 3-17 relates earthquake intensity to the maximum amount of ground acceleration (peak ground acceleration, or PGA) that is measured with a special instrument called a strong-motion accelerograph. Acceleration is measured as a percentage of the Earth's gravity. A vertical acceleration of one g would be just enough to lift you (or anything else) off the ground. Obviously, this would have a major impact on damage done by an earthquake at a given site. Peak ground velocity (PGV) is also routinely measured.

In the Pacific Northwest, creating an intensity map by use of questionnaires is now done on the Internet. If you feel an earthquake, go to <http://www.ess.washington.edu> and click on Pacific Northwest Earthquakes, which will take you to the Pacific Northwest Seismograph Network. Click on Report an Earthquake. This brings up the phrase, *Did You Feel It?* Click on your state and you can fill out a report and submit it electronically. The map that results shows intensity by zip code and is called the Community Internet Intensity Map (CIIM). Figure 3-16 shows the CIIM for the 2001 Nisqually Earthquake. An



earthquake of M 3.7 near Bremerton, Washington, on May 29, 2003, drew more than one thousand responses in the first twenty-four hours.

The Internet-derived intensity map is not generated fast enough to be of use to emergency managers, who need to locate quickly the areas of highest intensity, and thus the areas where damage is likely to be greatest. What resources must be mobilized, and where should they be sent? The *TriNet Project* was developed for southern California by the U.S. Geological Survey (USGS), Caltech, and the California Geological Survey with support from the Federal Emergency Management Agency (FEMA), taking advantage of the large number of strong-motion seismographs in the state, a detailed knowledge of active faults of the region, and of soil types likely to result in high accelerations. After the Northridge Earthquake of 1994, this project developed *ShakeMap*, which takes the calculated magnitude, depth, causative fault, direction of rupture propagation, and soil types to produce an intensity map within five minutes of the earthquake. The *ShakeMap* software was installed at the Pacific Northwest Seismograph Network at the University of Washington in January 2001, one month before the Nisqually Earthquake, and was still in test mode when that earthquake struck. The *ShakeMap* for this earthquake, which was made available to the public one day after the earthquake, is shown as Figure 3-17. You can access a *ShakeMap*, even for smaller earthquakes, through

<http://www.trinet.org/shake> or through the Pacific Northwest Seismograph Network website.

Community Internet Intensity Map (10 miles NNE of Lacey, Washington)  
 ID:2281854 10:54:33 PST FEB 28 2001 Mag=6.8 Latitude=N47.15 Longitude=W122.73

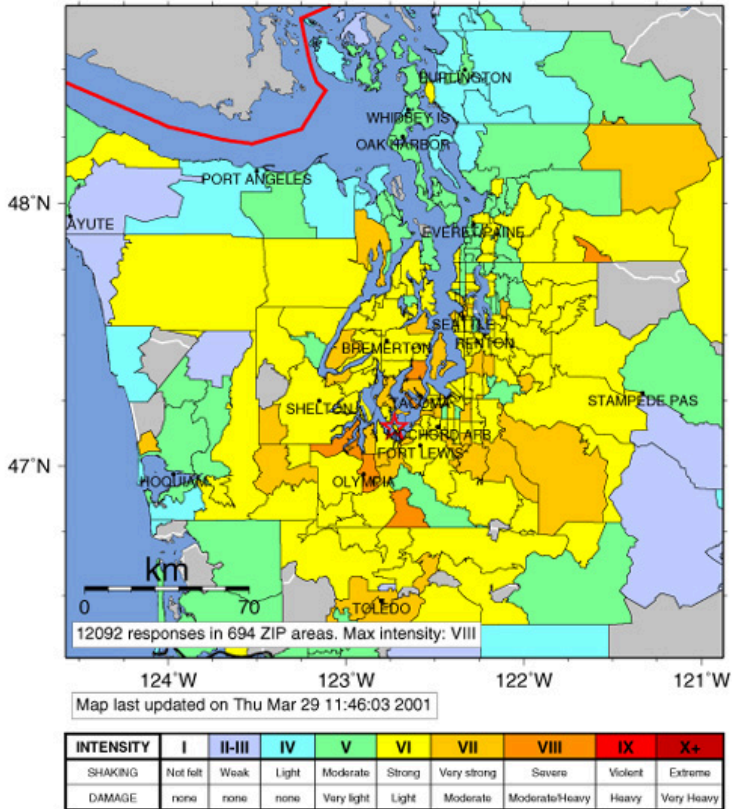

Figure 3-16. Community Internet Intensity map (CIIM) for the 2001 Nisqually Earthquake. Epicenter is the white star. Go to <https://earthquake.usgs.gov/data/dyfi/> on the USGS Web site or to the PNSN website, which brings up “Did You Feel It?” along with a brief questionnaire. Log on and complete the questionnaire, which includes your ZIP code. The figure shows the result of 12,092 responses from 694 ZIP code areas. The lightest shading is intensity VI; darker shade close to epicenter is intensity VII and VIII. From USGS Fact Sheet 030-01.

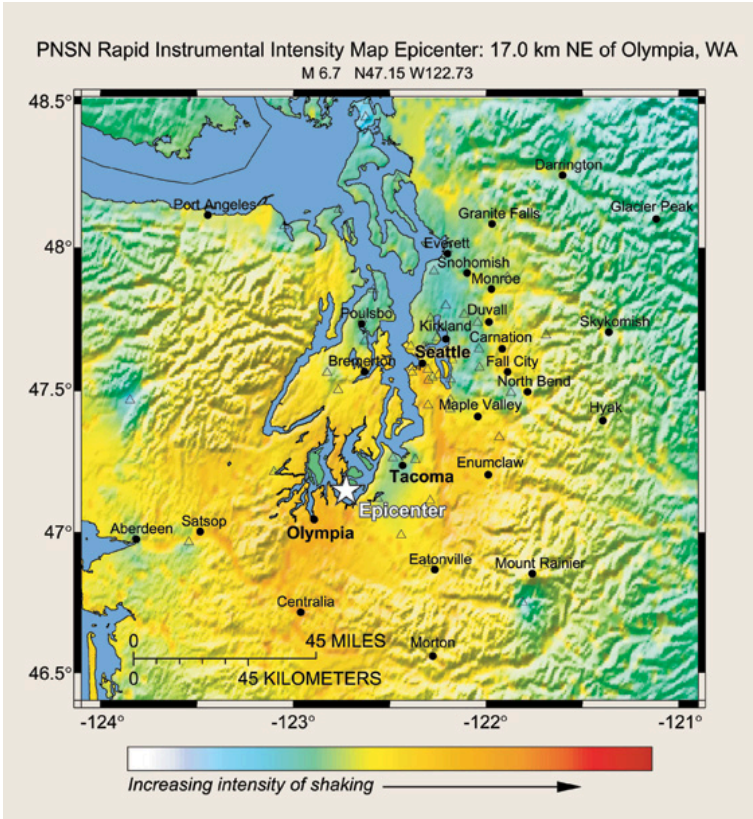

Figure 3-17. Experimental ShakeMap for Nisqually Earthquake based on forty-nine strong-motion seismograms (triangles), sixteen of which recorded peak accelerations greater than 10 percent  $g$  and two greater than 25 percent  $g$ . Map takes into account ground conditions and is generated automatically. Darker areas around epicenter (filled star) have accelerations greater than 9.2 percent  $g$ . Accelerations greater than 18 percent  $g$  are found in a linear band extending from Seattle toward Eatonville and patches south of Olympia and west of Interstate 5 as well as east of Olympia. The lighter patch in and southwest of Tacoma represents accelerations lower than 9 percent  $g$ . The objective of ShakeMap is to locate areas quickly enough to direct emergency services to the areas of strongest shaking. From the Pacific Northwest Seismograph Network.

As pointed out above, Intensities VII and VIII may result in major damage to poorly constructed buildings whereas well-constructed buildings should ride out those intensities with much less damage. This points out the importance of earthquake-resistant construction and strong building codes, discussed further in Chapters 11 and 12. Except for adobe, nearly all buildings will ride out intensities of VI or less, even if they are poorly constructed. For the rare occasions when intensities reach XI or XII, many buildings will fail, even if they are well constructed. But for the more common intensities of VII through X, earthquake-resistant construction will probably mean the difference between collapse of the building, with loss of life, and survival of the building and its inhabitants.

Measurements of intensity are the only way to estimate the magnitudes of historical earthquakes that struck before the development of seismographs. Magnitude estimates based on intensity data have been made for decades, but these were so subjective that magnitude estimates and epicenter locations made in this way were unreliable. For example, the epicenter of the poorly understood earthquake of December 14, 1872 has been placed at many locations in northeastern Washington and even in southern British Columbia, with magnitude estimates as high as M 7.4. Can these estimates be made more quantitative, and thereby more useful in earthquake hazard estimates?

Bill Bakun and Carl Wentworth of the USGS figured out a way to do it. First, they had to cope with the

behavior of seismic waves passing through parts of the Earth that react to seismic waves in different ways. Seismic waves die out (*attenuate*) more rapidly in some parts of the Earth than in others. It's like hitting a sawed log with a hammer and listening for the sound at the other end. If the wood is good, the hammer makes a clean sound. If the wood is rotten, however, the hammer goes "thunk". By measuring the attenuation ("thunkiness") and wave speeds of more recent earthquakes that have had magnitudes determined by seismographs, Bakun and Wentworth were able to calibrate the behavior of the Earth's crust in the vicinity of pre-instrumental earthquakes in the same region. The magnitude measured in this way is called *intensity magnitude*, or MI.

Bakun teamed with several colleagues, including Ruth Ludwin of the University of Washington and Margaret Hopper of the USGS, who had already done a study of the 1872 earthquake, and analyzed twentieth-century earthquakes with instrumentally determined magnitudes both east and west of the Cascades to take into account the different behavior of the Earth's crust in western as compared to eastern Washington. They compared the intensities from these modern earthquakes with the intensities reported from the 1872 earthquake at seventy-eight locations to find the epicenter and magnitude that best matched the pattern of intensity observed in 1872. The earthquake, they determined, was located south of Lake Chelan with MI

estimated as 6.8. (This earthquake is discussed further in Chapter 6.)

### c. Fault-Plane Solutions

In the early days of seismography, it was enough to locate an earthquake accurately and to determine its magnitude. But seismic waves contain much more information, including the determination of the type of faulting. The seismogram shows that the first motion of an earthquake P-wave is either a push toward the seismograph or a pull away from it. With the modern three-component networks in the Northwest and adjacent parts of Canada, it is possible to determine the push or pull relationship at many stations, leading to information about whether the earthquake is on a reverse fault, a normal fault, or a strike-slip fault (as illustrated in Figure 3-18, which indicates the earthquake was on a normal fault in which the earthquake wave pushed outward horizontally from the hypocenter, similar to the 1993 Klamath Falls Earthquake). Most earthquakes are not accompanied by surface faulting, so the *fault-plane solutions* are the best evidence of the type of fault causing the earthquake. The fault generating the September 1993 Klamath Falls, Oregon, Earthquake did not rupture the surface, but their fault-plane solutions showed that they were caused by rupture of a normal fault striking

approximately north-northwest, in agreement with the local geology (for further discussion, see Chapter 6). Seismic waves recorded digitally on broadband seismographs are able to record many frequencies of seismic waves. These can be analyzed to show that an earthquake may consist of several ruptures within a few seconds of each other, some with very different fault-plane solutions.



*A video element has been excluded from this version of the text. You can watch it online here:*

<https://open.oregonstate.education/earthquakes/?p=65>

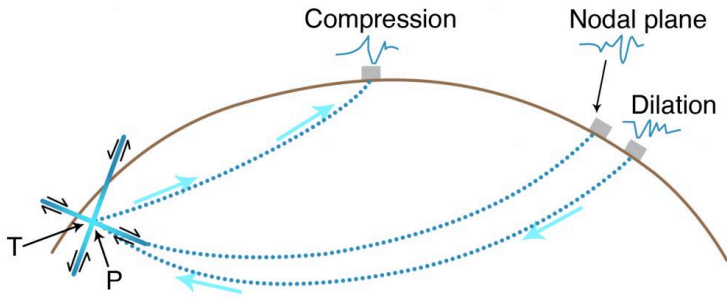

Figure 3-18. Use of first motion of seismic wave at several seismographs (open boxes) to determine mode of earthquake faulting. One seismogram shows a compression (first wave goes up, reading from left to right), indicating that the first motion was away from the source. Another shows a dilation (first wave goes down), indicating that the first motion was toward the source. A third is indeterminate, suggesting that it is on the boundary between compression and dilation. From this, we can determine that the earthquake was on a normal fault, even though we don't know which of the two planes is the true fault plane. Lines are curved because of different speeds of seismic waves in the Earth. Modified from Yeats et al. (1997), with permission of Oxford University Press.

## 7. Measuring Crustal Deformation Directly: Tectonic Geodesy

As stated at the beginning of this chapter, Harry F. Reid based his elastic rebound theory on the displacement of survey benchmarks relative to one another. These benchmarks recorded the slow elastic deformation of



the Earth's crust prior to the 1906 San Francisco Earthquake. After the earthquake, the benchmarks snapped back, thereby giving an estimate of tectonic deformation near the San Andreas Fault independent of seismographs or of geological observations. Continued measurements of the benchmarks record the accumulation of strain toward the next earthquake. If geology records past earthquakes and seismographs record earthquakes as they happen, measuring the accumulation of tectonic strain says something about the earthquakes of the future.

Reid's work means that a major contribution to the understanding of earthquakes can be made by a branch of civil engineering called *surveying*: land measurements of the distance between survey markers (*trilateration*), the horizontal angles between three markers (*triangulation*), and the difference in elevation between two survey markers (*leveling*).

Surveyors need to know about the effects of earthquakes on property boundaries. Surveying normally implies that the land stays where it is. But if an earthquake is accompanied by a ten-foot strike-slip offset on a fault crossing your property, would your property lines be offset, too? In Japan, where individual rice paddies and tea gardens have property boundaries that are hundreds of years old, property boundaries are offset. A land survey map of part of the island of Shikoku shows rice paddy property boundaries offset by a large earthquake fault in A.D. 1596.

The need to have accurate land surveys leads to the

science of *geodesy*, the study of the shape and configuration of the Earth, a discipline that is part of civil engineering. *Tectonic geodesy* is the comparison of surveys done at different times to reveal deformation of the crust between the times of the surveys.

Following Reid's discovery, the U.S. Coast and Geodetic Survey (now the National Geodetic Survey) took over the responsibility for tectonic geodesy, which led them into strong-motion seismology. For a time, the Coast and Geodetic Survey was the only federal agency with a mandate to study earthquakes (see Chapter 13).

After the great Alaska Earthquake of 1964, the USGS began to take an interest in tectonic geodesy as a way to study earthquakes. The leader in this effort was a young geophysicist named Jim Savage, who compared surveys before and after the earthquake to measure the crustal changes that accompanied the earthquake. The elevation changes were so large that along the Alaskan coastline, they could be easily seen without surveying instruments: sea level appeared to rise suddenly where the land went down, and it appeared to drop where the land went up. (Of course, sea level didn't actually rise or fall, the land level changed.)

Up until the time of the earthquake, some scientists believed that the faults at deep-sea trenches were vertical. But Savage, working with geologist George Plafker, was able to use the differences in surveys to show that the great subduction-zone fault that had generated the earthquake dips gently northward, underneath the Alaskan landmass. Savage and Plafker

then studied an even larger subduction-zone earthquake that had struck southern Chile in 1960 (Moment Magnitude  $M_w$  9.5, the largest earthquake ever recorded) and showed that the earthquake fault in the Chilean deep-sea trench dipped beneath the South American continent. Seismologists, using newly established high-quality seismographs set up to monitor the testing of nuclear weapons, confirmed this by showing that earthquakes defined a landward-dipping zone that could be traced hundreds of miles beneath the surface. These became known as *Wadati-Benioff zones*, named for the seismologists who first described them. All these discoveries were building blocks in the emerging new theory of plate tectonics.

In 1980, Savage turned his attention to the Cascadia Subduction Zone off Washington and Oregon. This subduction zone was almost completely lacking in earthquakes and was thought to deform without earthquakes. But Savage, resurveying networks in the Puget Sound area and around Hanford Nuclear Reservation in eastern Washington, found that these areas were accumulating elastic strain, like areas in Alaska and the San Andreas Fault. Then John Adams, a young New Zealand geologist transplanted to the Geological Survey of Canada, remeasured leveling lines across the Coast Range and found that the coastal region was tilting eastward toward the Willamette Valley and Puget Sound, providing further evidence of elastic deformation. These geodetic observations were critical in convincing scientists that the Cascadia

Subduction Zone was capable of large earthquakes, like the subduction zones off southern Alaska and Chile (see Chapter 4).

At the same time, the San Andreas fault system was being resurveyed along a spider web of line-length measurements between benchmarks on both sides of the fault. Resurveys were done once a year, more frequently later in the project. The results confirmed the elastic-rebound theory of Reid, and the large number of benchmarks and the more frequent surveying campaigns added precision that had been lacking before. Not only could Savage and his coworkers determine how fast strain is building up on the San Andreas, Hayward, and Calaveras faults, they were even able to determine how deep within the Earth's crust the faults are locked.

After an earthquake in the San Fernando Valley near Los Angeles in 1971, Savage relevelled survey lines that crossed the surface rupture. He was able to use the geodetic data to map the source fault dipping beneath the San Gabriel Mountains, just as he had done for the Alaskan Earthquake fault seven years before. The depiction of the source fault based on tectonic geodesy could be compared with the fault as illuminated by the distribution of aftershocks and by the surface geology of the fault scarp. This would be the wave of the future in the analysis of California earthquakes.

Still, the land survey techniques were too slow, too cumbersome, and too expensive. A major problem was that the baselines were short, because the surveyors

had to see from one benchmark to the other to make a measurement.

The solution to the problem came from space.

First, scientists from the National Aeronautical and Space Administration (NASA) discovered mysterious, regularly spaced radio signals from quasars in deep outer space. By analyzing these signals simultaneously from several radio telescopes as the Earth rotated, the distances between the radio telescopes could be determined to great precision, even though they were hundreds of miles apart. And these distances changed over time. Using a technique called Very Long Baseline Interferometry (VLBI), NASA was able to determine the motion of radio telescopes on one side of the San Andreas Fault with respect to telescopes on the other side. These motions confirmed Savage's observations, even though the radio telescopes being used were hundreds of miles away from the San Andreas Fault.

Length of baseline ceased to be a problem, and the motion of a radio telescope at Vandenberg Air Force Base could be compared to a telescope in the Mojave Desert, in northeastern California, in Hawaii, in Japan, in Texas, or in Massachusetts. Using VLBI, NASA scientists were able to show that the motions of plate tectonics measured over time spans of hundreds of thousands of years are at the same rate as motions measured for only a few years—plate tectonics in real time.

But there were not enough radio telescopes to equal Savage's dense network of survey stations across the

San Andreas Fault. Again, the solution came from space, this time from a group (called a *constellation*) of NAVSTAR satellites that orbit the Earth at an altitude of about twelve thousand miles. This developed into the Global Positioning System, or GPS.

GPS was developed by the military so that smart bombs could zero in on individual buildings in Baghdad or Belgrade, but low-cost GPS receivers allow hunters to locate themselves in the mountains and fishing boats to be located at sea. You can install one on the dashboard of your car to find where you are in a strange city. GPS is now widely used in routine surveying. In tectonic geodesy, it doesn't really matter where we are *exactly*, but only where we are *relative to the last time we measured*. This allows us to measure small changes of only a fraction of an inch, which is sufficient to measure strain accumulation. Uncertainties about variations in the troposphere high above the Earth mean that GPS does much better at measuring horizontal changes than it does vertical changes; leveling using GPS is less accurate than leveling based on ground surveys.

NASA's Jet Propulsion Lab at Pasadena, together with scientists at Caltech and MIT, began a series of survey campaigns in southern California in the late 1980s, and they confirmed the earlier ground-based and VLBI measurements. GPS campaigns could be done quickly and inexpensively, and, like VLBI, it was not necessary to see between two adjacent ground survey points. It

was only necessary for all stations to lock onto one or more of the orbiting NAVSTAR satellites.

In addition to measuring the long-term accumulation of elastic strain, GPS was able to measure the release of strain in the 1992 Landers Earthquake in the Mojave Desert and the 1994 Northridge Earthquake in the San Fernando Valley. The survey network around the San Fernando Valley was dense enough that GPS could determine the size and orientation of the source fault plane and the amount of displacement during the earthquake. This determination of magnitude was independent of the fault source measurements made using seismography or geology.

In addition to measuring the long-term accumulation of elastic strain, GPS was able to measure the release of strain in the 1992 Landers Earthquake in the Mojave Desert and the 1994 Northridge Earthquake in the San Fernando Valley. The survey network around the San Fernando Valley was dense enough that GPS could determine the size and orientation of the source fault plane and the amount of displacement during the earthquake. This determination of magnitude was independent of the fault source measurements made using seismography or geology.

By the time of the Landers Earthquake, tectonic geodesists recognized that campaign-style GPS, in which teams of geodesists went to the field several times a year to remeasure their ground survey points, was not enough. The measurements needed to be more frequent, and the time of occupation of individual sites

needed to be longer, to increase the level of confidence in measured tectonic changes and to look for possible short-term geodetic changes that might precede an earthquake. So permanent GPS receivers were installed at critical localities that were shown to be stable against other types of ground motion unrelated to tectonics, such as ground slumping or freeze-thaw. The permanent network was not dense enough to provide an accurate measure of either the Landers or the Northridge earthquake, but the changes they recorded showed great promise for the future.

After Northridge, geodetic networks were established in southern California, the San Francisco Bay Area, and the Great Basin area including Nevada and Utah. In the Pacific Northwest, a group of scientists including Herb Dragert of the Pacific Geoscience Centre in Sidney, B.C., and Meghan Miller, then of Central Washington University in



*Figure 3-19. Global Positioning System (GPS) survey, part of the Pacific Northwest Geodetic Array (PANGA), of a rock outcrop on the Snow Dome on the north side of Mount Olympus, Olympic National Park. Photo by Spencer Reeder, Central Washington University*

Ellensburg, organized networks for the Pacific Northwest called the Pacific Northwest Geodetic Array (PANGA) and Western Canada Deformation Array, building on the ongoing work of Jim Savage and his



colleagues at the USGS. Figure 3-19 shows a GPS receiver being used to measure coseismic deformation within the PANGA network, in this case in Olympic National Park, where on eif the early GPS studies in the Northwest was done under the direction of Jim Savage. The permanent arrays are still augmented by GPS campaigns to obtain more dense coverage than can be obtained with permanent stations. The PANGA array shows that the deformation of the North American crust is relatively complicated, including clockwise rotation about an imaginary point in northeasternmost Oregon and north-south squeezing of crust in the Puget Sound (Figure 3-20). This clockwise rotation was not recognized prior to GPS, but it is clearly an important first-order feature.

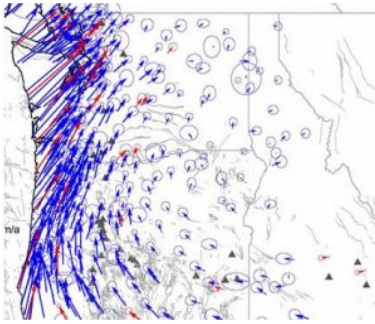

Fig. 3-20. Crustal motion of GPS stations relative to stable North America based on GPS surveys conducted by Pacific Northwest Geodetic Array and Western Canada Geodetic Array. Length of arrow relative to speed of station relative to North America; ellipses at arrow points represent measurement error. Map produced by Rob McCaffrey, Portland State University.

The Landers Earthquake produced one more surprise from space. A European satellite had been obtaining radar images of the Mojave Desert before the earthquake, and it took more images afterwards. Radar images are like regular aerial photographs, except that the image is based on sound waves rather than light waves. Using a computer, the before and after images were laid on top of each other, and

where the ground had moved during the earthquake, it revealed a striped pattern, called an *interferogram*. The displacement patterns close to the rupture and in mountainous terrain were too complex to be seen, but farther away, the radar interferometry patterns were simpler, revealing the amount of deformation of the crust away from the surface rupture. The displacements matched the point displacements measured by GPS, and as with GPS, radar interferometry provided still another independent method to measure the displacement produced by the earthquake. The technique was even able to show the

deformation pattern of some of the larger Landers aftershocks. Interferograms were created for the Northridge and Hector Mine earthquakes; they have even been used to measure the slow accumulation of tectonic strain east of San Francisco Bay and the swelling of the ground above rising magma near the South Sister volcano in Oregon.

## 8. Summary

Earthquakes result when elastic strain builds up in the crust until the strength of the crust is exceeded, and the crust ruptures along a fault. Some of the fault ruptures do not reach the surface and are detected only by seismograms, but many larger earthquakes are accompanied by surface rupture, which can be studied by geologists. Reverse faults are less likely to rupture the surface than strike-slip faults or normal faults. A special class of low-angle reverse fault called a blind thrust does not reach the surface, but does bend the rocks at the surface into a fold called an anticline. Paleoseismology extends the description of contemporary earthquakes back into prehistory, with the objective of learning the slip rate and the recurrence interval of earthquakes along a given fault.

In the last century, earthquakes have been recorded on seismograms, with the size of the earthquake, its magnitude, expressed by the amplitude of the

earthquake wave recorded at the seismograph station, and the distance the earthquake is from the seismograph station based on the delay in arrival time of slower shear (S) waves compared to compressional (P) waves. A problem with measuring earthquake size in this way is the broad spectrum of seismic vibrations produced by the earthquake orchestra. A better measure of the size of large earthquakes is the moment magnitude, calculated from the area of fault rupture and the fault displacement during the earthquake. In addition to magnitude, seismographs measure earthquake depth and the nature and orientation of fault displacement at the earthquake source.

Earthquake intensity is a measure of the degree of strong shaking at a given locality, important for studying damage. Information from a dense array of seismographs in urban areas, when combined with fault geology and surface soil types, permits the creation of intensity maps within five minutes of an earthquake, which is quick enough to direct emergency response teams to areas where damage is likely to be greatest. Based on the better knowledge of the Earth's crust in well-instrumented areas, it is even possible to determine the magnitude of earthquakes that struck in the pre-seismograph era.

Tectonic geodesy, especially the use of GPS, allows the measurement of long-term buildup of elastic strain in the crust and the release of strain after a major earthquake. If geology records past earthquakes and seismography records earthquakes as they happen,

tectonic geodesy records the buildup of strain toward the earthquakes of the future.

## 9. Cascadia Earthquake Sources

The next three chapters describe the three sources of earthquakes in the Pacific Northwest (Figure 3-21). Chapter 4 describes the first and largest source, the boundary between the Juan de Fuca-Gorda Plate and the North America Plate, known as the Cascadia Subduction Zone (solid red line in Figure 3-21). Chapter 5 describes deep earthquakes, largely onshore, within the downgoing Juan de Fuca Plate, called slab earthquakes. Chapter 6 describes earthquakes within the North America Plate, including the Seattle fault in Washington and two earthquakes in Oregon in 1993.

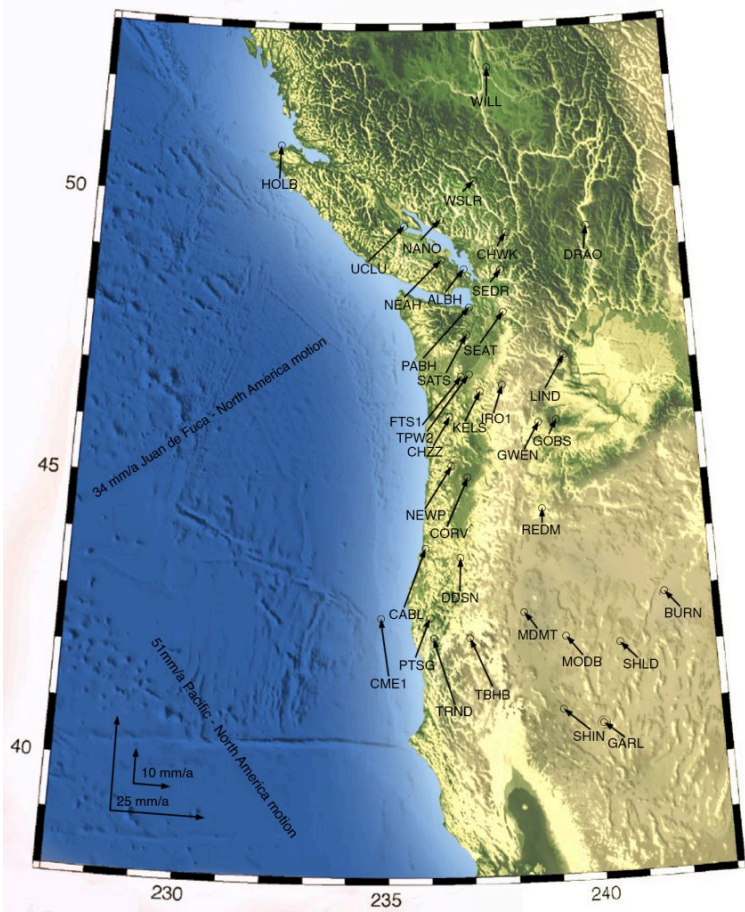

Figure 3-21. Cascadia earthquake sources. Red line shows Cascadia Subduction Zone, discussed in Chapter 4. Pink circles identify earthquakes in the subducting Juan de Fuca Plate, covered in Chapter 5, and yellow circles identify crustal earthquakes, including the Seattle fault that sustained an earthquake in about 900 AD, covered in Chapter 6.

## *Suggestions for Further Reading*

- Bakun, W. H., R. A. Haugerud, M. G. Hopper, and R. S. Ludwin. 2002. The December 1872 Washington State Earthquake: Bulletin of the Seismological Society of America, v. 92, p. 3239-58.
- Bakun, W. H., and C. M. Wentworth. 1997. Estimating earthquake location and magnitude from seismic intensity data: Bulletin of the Seismological Society of America, v. 87, p. 1502-21.
- Bolt, B. A. 2004. Earthquakes: 5th Edition: New York: W. H. Freeman & Co., 378 p. A more detailed discussion of seismographs and seismic waves, written for the lay person.
- Brumbaugh, D. S. 1999. Earthquakes: Science and Society. Upper Saddle River, NJ: Prentice-Hall. An in-depth coverage of earthquakes, instruments used in describing them, and personal safety and building construction standards.
- Committee on the Science of Earthquakes. 2003. Living on an Active Earth: Perspectives on Earthquake Science. Washington, D.C.: National Academy Press, 418 p., [www.nap.edu](http://www.nap.edu)
- Carter, W. E., and D. S. Robertson. 1986. Studying the earth by very-long-baseline interferometry: Scientific American, v. 255, no. 5, p. 46-54. Written for the lay person.
- Dixon, T. H. 1991. An introduction to the Global

- Positioning System and some geological applications: *Reviews of Geophysics*, v. 29, p. 249-76.
- Hough, S. E. 2002. *Earthshaking Science: What We Know (And Don't Know) About Earthquakes*. Princeton, NJ: Princeton University Press, 238 p. Written for the lay person.
- Iris Seismic Monitor. <http://www.iris.edu/seismon/> Monitor earthquakes around the world in near-real time, visit worldwide seismic stations. Earthquakes of M 6 or larger are linked to special information pages that explain the where, how, and why of each earthquake.
- Lee, W. H. K. 1992. *Seismology, observational*. Academic Press, *Encyclopedia of Physical Science and Technology*, v. 15, p. 17-45.
- Lillie, R. J. 1999. *Whole-Earth Geophysics*: Englewood Cliffs, NJ: Prentice-Hall, 361 p.
- Prescott, W. H., J. L. Davis, and J. L. Svarc. 1989. Global positioning system measurements for crustal deformation: Precision and accuracy. *Science*, v. 244, p. 1337-40.
- Richter, C. F., 1958, *Elementary Seismology*: San Francisco: W.H. Freeman and Co., 468 p. The classic textbook in earthquake seismology, still useful after more than forty years.
- Scholz, C. 2002. *Mechanics of Earthquakes and Faulting*, Second Edition. Cambridge University Press, 496 p. A technical treatment of how rocks deform and produce earthquakes.



- SCIGN website designed as a learning module for tectonic geodesy: <http://scign.jpl.nasa.gov/learn/>
- Wald, D. J., V. Quitoriano, T. Heaton, H. Kanamori, C. W. Scrivner, and C. W. Worden. 1999. TriNet ShakeMaps: Rapid generation of instrumental ground motion and intensity maps for earthquakes in southern California. *Earthquake Spectra*, v. 15, p. 537-55.
- Wald, D. J., C. B. Worden, and V. Quatoriano. 2002. ShakeMap: an update. *Seismological Research Letters*, v. 73, p. 255.
- Yeats, R. S., K. E. Sieh, and C. R. Allen. 1997. *The Geology of Earthquakes*. New York: Oxford University Press, 568 p., chapters 2, 3, 4, and 5, p. 17-113.

## 4. Cascadia Subduction Zone

*“Then there were lightning flashes, rumblings, and peals of thunder, and a great earthquake. It was such a violent earthquake that there has never been one like it since the human race began on Earth.”*

Book of Revelation 16:18

*“Earthquake said, ‘Well, I shall tear up the earth.’ Thunder said, ‘That’s why I say we will be companions, because I shall go over the whole world and scare them. ...’ So [Thunder] began to run, and leaped on trees and broke them down. Earthquake stayed still to listen to his running. Then he said to him, ‘Now you listen: I shall begin to run.’ He shook the ground. He tore it and broke it in pieces. . . All the trees shook; some fell.”*

Yurok legend told by Tskerkr of Espeu,  
recorded by A. L. Kroeber

## I. Discoveries Beneath the Sea

It is late summer of 1989. Chris Goldfinger and Bruce Appelgate, graduate students at Oregon State University, and electronics technician Kevin Redman of Williamson and Associates, are in the science lab of OSU's research ship *Wecoma*, looking on the TV monitor at side-scan sonar imagery taken as the *Wecoma* cruises above the base of the continental slope along the Cascadia Subduction Zone off central Oregon. The ship tows a "fish," an instrument gliding thousands of feet beneath the sea surface and emitting sound signals that echo back from the sea floor to the fish and are then transmitted to the lab aboard ship. On the video screen, these images look like aerial photos, showing the ocean floor in black and white in unprecedented clarity and detail. But these "photos" are created from reflected sound waves, not reflected light. The experience is like being in a balloon drifting slowly through the sky, and looking down at a hitherto-unseen landscape. It is late summer of 1989,

Suddenly Goldfinger sees a fault. Crossing the screen in a straight line, it offsets by strike slip a sea-floor channel and a landslide, and it buckles the sea floor into a low hill. The image of the faulted channel on the video screen looks oddly like a man with a guitar, so naturally it becomes known as "Elvis" (Figure 4-1). Unfortunately, that name doesn't stick, and it is formally named the *Wecoma* Fault for the ship that found it.

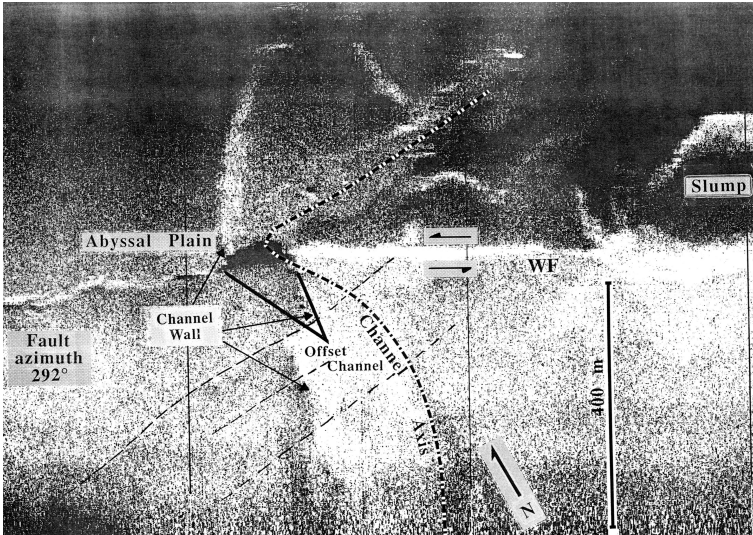

Figure 4-1. Elvis image, marking point of discovery of the Wecoma Fault, which offsets a deep-sea channel about one hundred meters (more than three hundred feet). Slip rate on this left-lateral strike-slip fault is about one inch every four years. Image acquired by SeaMarc 1A side-scan sonar, with sound coming from bottom of image. (Elvis's head and upper body, holding a guitar, are at top of image.) Image courtesy of Chris Goldfinger, College of Earth, Ocean, and Atmospheric Sciences, Oregon State University.

Later, the research submarine *Alvin* would descend to the pitch-black base of the continental slope, and scientists in the crowded cockpit of the sub would locate the fault zone in the glare of the headlights of the sub and sample it. The rocks are strongly sheared, with linear grooves, proof that this is a place where rock grinds against rock.

Using side-scan sonar imagery and topographic

mapping of the sea floor by the National Oceanic and Atmospheric Administration (NOAA), Goldfinger would find at least nine of these strike-slip faults off the Washington and Oregon coast, cutting both the Juan de Fuca Plate and the adjacent North American continental slope. He and Mary MacKay of the University of Hawaii would find active folds buckled up as the Juan de Fuca Plate drives beneath the North American continent (Figure 4-2). Their conclusion: the lower part of the North American continent close to the subduction zone is everywhere being crushed and deformed into faults and folds, like snow on the front of a snowplow blade. The source of the destruction: a much larger fault, previously hidden, which slopes gently landward beneath this highly deformed zone, as shown by a seismic-reflection profile similar to those acquired by the petroleum industry (Figure 4-2).

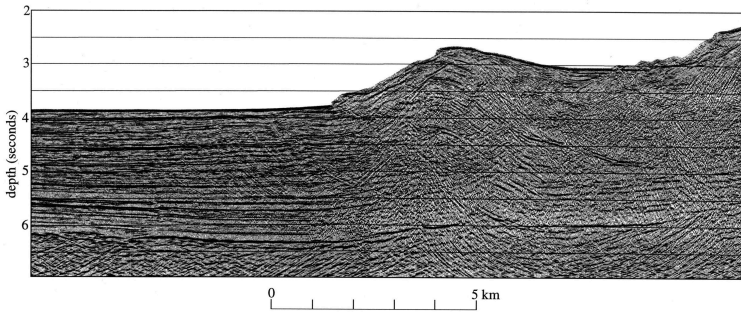

Figure 4-2. Seismic-reflection profile of the Cascadia Subduction Zone off central Oregon. West is to the left. Signals from a ship were bounced off the sea floor and off more deeply buried sediment layers, then echoed back to the ship, allowing a profile to be made that shows the geology beneath the sea floor. The flat sea floor on the left is the sediment-covered abyssal plain of the Juan de Fuca Plate. The Cascadia Subduction Zone has thrust highly deformed rocks of the North America Plate over the flat Juan de Fuca Plate. The fault slopes gently to the east. Sediment layers at the left are being forced under the edge of the continent and, in addition, dragged up against the edge of the continent as an accretionary wedge. Profile acquired in 1989 by Digicon for the National Science Foundation. Image courtesy of LaVerne D. Kulm and Chris Goldfinger, College of Earth, Ocean, and Atmospheric Sciences, Oregon State University.

In oceanographic expeditions criss-crossing the base of the continental slope, one of the world's great earthquake faults is slowly coming into view (Figure 4-3), a fault that carries the North American continent on its back as it crushes the deep-sea sediment of the Juan de Fuca Plate beneath it. For three decades after the first discovery that Cascadia is an active subduction zone, the fault itself could only be viewed by seismic-

reflection profiles (Figure 4-2) and by relatively crude depth soundings. With new technology developed by NOAA, the fault can be imaged at the base of the continental slope from Vancouver Island to northern California. On the west side of the fault is the broad sediment-covered plain of the Juan de Fuca Plate, marked only by long, meandering channels carved by sand-laden currents that flow along the sea floor (Figure 4-4). This plain stretches away westward to the Juan de Fuca Ridge (Figures 2-4, 4-5), where new oceanic crust is formed by volcanoes at rifts along the ridge axis.

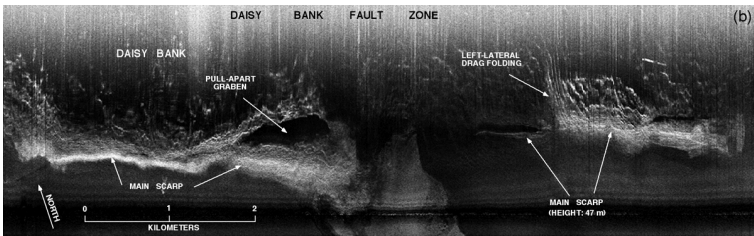

Figure 4-3a. Sidescan sonar image of Daisy Bank strike-slip fault west of Newport. These structures are similar to those on subaerial faults in California. Image from Chris Goldfinger.

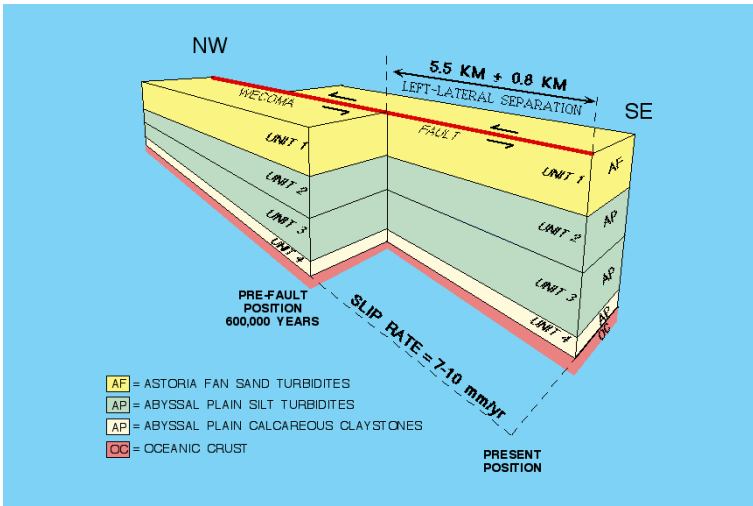

Figure 4-3b. 3D diagram showing how differences in thickness of faulted layers can be matched to give total strike slip on fault. If the age of the layers is known, the rate of slip on the fault may be determined. Based on work by Chris Goldfinger.

East of the subduction-zone fault, the continental slope rises as a rugged mountain wall, with fold ridges heaved up where the plates converge (Figures 4-4, 4-5). The lower part of the continental block is cut by west-northwest-trending strike-slip faults (Figures 4-1, 4-3a, b), formed because the Juan de Fuca Plate intersects North America obliquely, and North America is deformed like a stack of books on a shelf. Figure 4-3a shows the Daisy Bank fault west of Newport, showing structures similar to those formed by strike-slip faults in California. If the ages of sedimentary layers are known, the strike-slip rate on the fault may be



determined (Figure 4-3b). Landslides off southern Oregon, also related to subduction, are tens of miles across. Off Washington, the continental slope is carved into great submarine canyons, including the Astoria Canyon off the coast of northern Oregon, west of the mouth of the Columbia River (Figure 4-4). North of the Astoria Canyon is another canyon, then another and another, cutting deeply into the slope off Washington (Figure 4-5). At the top of the slope is the continental shelf, a flat surface carved during lower sea-levels of the Ice Ages. East of that, finally, is the shoreline itself (Figure 4-5).

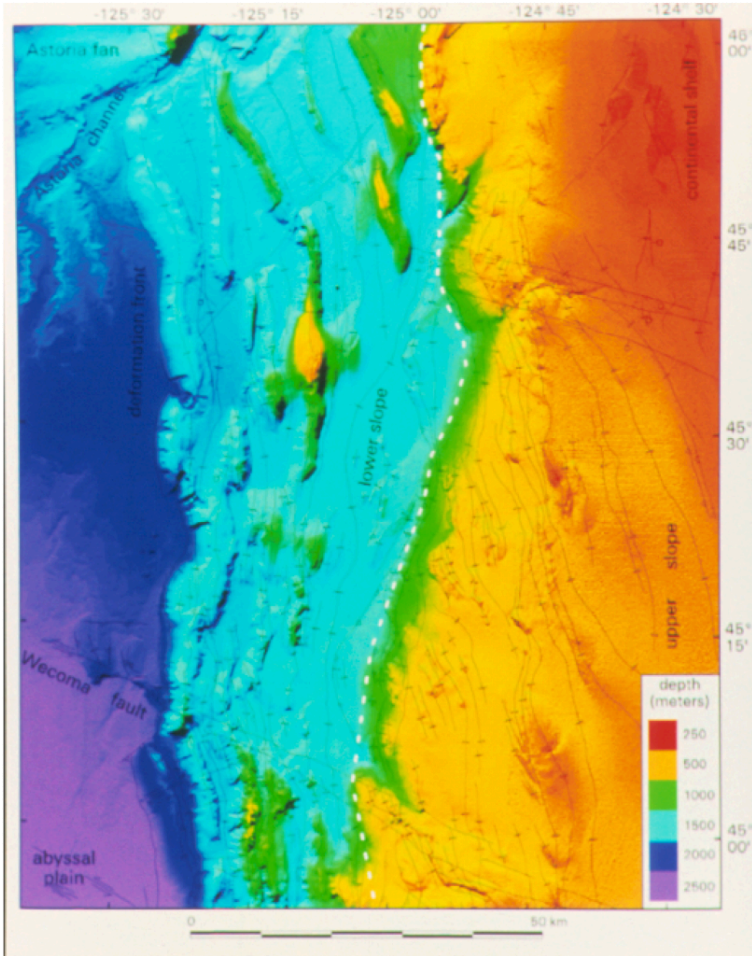

Figure 4-4. Computer-generated sea-floor image of the Oregon continental slope west of Seaside and Cannon Beach, based on sea floor topographic mapping by the National Oceanic and Atmospheric Administration. Elongate hills are anticlines formed by folding of sediment when plates collided at the Cascadia Subduction Zone (marked “deformation front”). The seaward end of the Astoria Submarine Canyon and Channel is seen at upper left. Canyons such as this contain turbidity-current deposits triggered by subduction-zone earthquakes. Image courtesy of Chris Goldfinger, College of Earth, Ocean and Atmospheric Sciences, Oregon State

University.

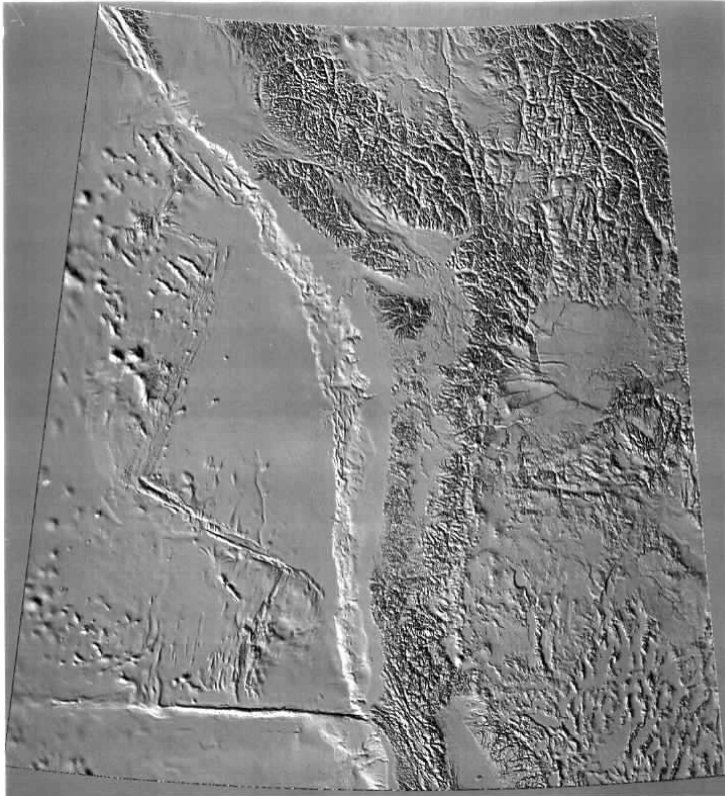

Figure 4-5. Computer-generated map (Digital Elevation Model or DEM) of Pacific Northwest, both on land and offshore. The continental slope is the boundary between the continental North American Plate and oceanic Juan de Fuca and Gorda plates, which is the Cascadia Subduction Zone. North of Vancouver Island, the boundary is the Queen Charlotte strike-slip fault. The Gorda and Juan de Fuca ridges and Blanco Fracture Zone are visible on the deep ocean floor. Note the Mendocino Fracture Zone at the southern end of the DEM, which is the boundary with the Pacific Plate to south.

These submarine canyons were not eroded by running water, as canyons on land are, because the continental slope was never above sea level. They were cut during the last few hundred thousand years, in the Pleistocene, by slurries of water and sand brought to the sea by the Columbia River, swollen with floodwater from melting ice sheets in British Columbia and the Rocky Mountains, and by other major rivers draining melting glaciers in Puget Sound and surrounding mountains and flowing west through the present Strait of Juan de Fuca and down a broad valley south of the Olympic Mountains of southwest Washington. The muddy and sandy water was heavier than clear seawater, so it churned violently down the continental slope like great snow avalanches, carving the submarine canyons in the process (Fig. 4-6). The avalanches traveled for hundreds of miles, far out onto the Juan de Fuca Abyssal Plain. When the currents finally stopped, the sediment settled out as *turbidites*, sand and mud deposits named for the turbid water that carried them.

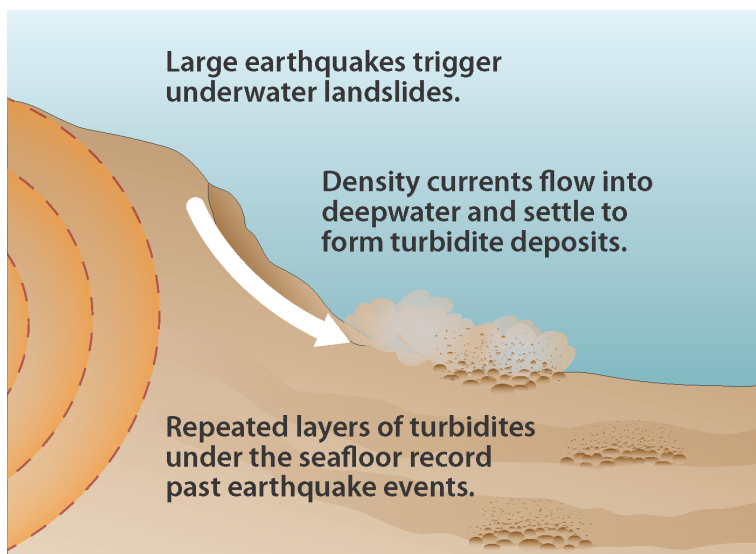

Figure 4-6. Diagrammatic representation of Cascadia turbidite sand avalanche triggered by a subduction-zone earthquake. Figure prepared by Kathleen Cantner, American Geosciences Institute, used with permission.

In the ten thousand years since the Pleistocene, the Columbia River floods have been smaller, more like they are today, and they no longer have the energy to generate the sediment avalanches that carved the submarine canyons and deposited the thick turbidite layers in the Pleistocene. However, Hans Nelson and Gary Griggs, when they were graduate students at OSU working under the direction of Professor LaVerne Kulm, found thinner turbidite layers deposited within the Pleistocene channels, even far out on the abyssal plain. Interspersed among these turbidites is a layer of ash

deposited on land by the cataclysmic eruption of Mt. Mazama to form Crater Lake 7,700 years ago (Figure 4-7), then washed into the Columbia River by its tributaries and carried out to sea. These turbidites were clearly not related to the melting of Pleistocene glaciers, so how could they have formed?

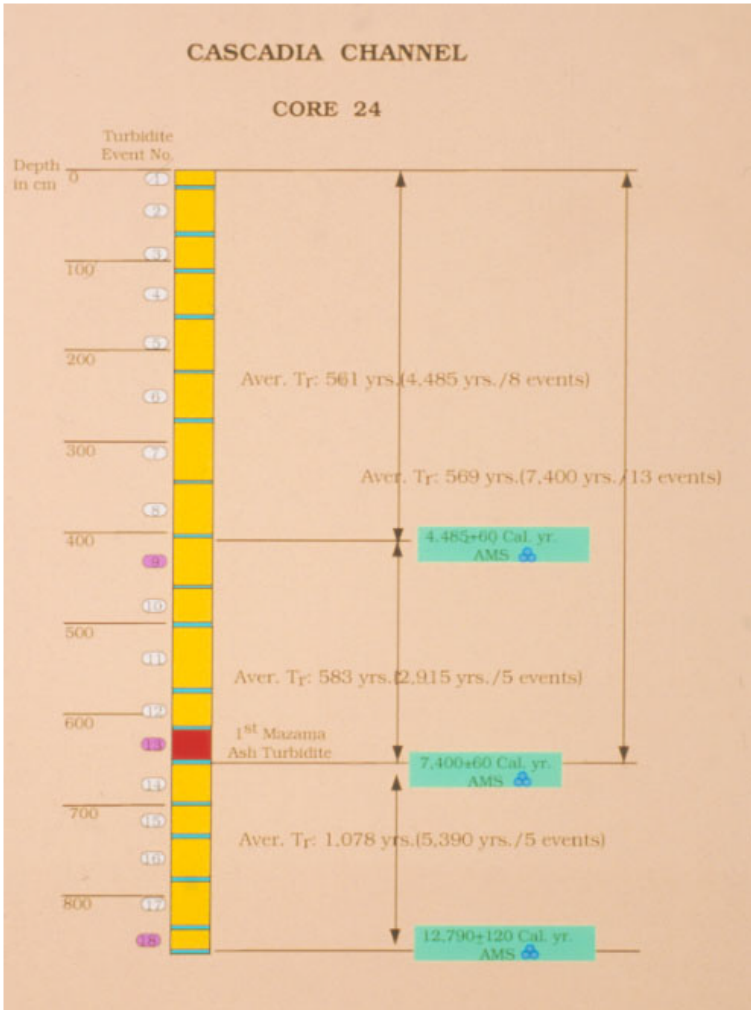

Figure 4-7. Ten thousand year record of Cascadia Subduction Zone earthquakes based on earthquake size. Strain builds up on subduction zone and is released in a great earthquake (vertical line). Time between earthquakes is variable, with the longest interval 1100 years (between 4800 and 5900 years before present) and the shortest interval less than 500 years (300-500 years before present). Size of earthquake is based on the turbidite record, with the largest earthquake 8800 years ago, much larger than the 1700 A.D. earthquake. From Chris

John Adams had been an invited guest at a meeting of the Oregon Academy of Sciences in 1987 debating the paradigm change of great earthquakes in the Pacific Northwest (discussed in the Introduction). After the meeting, Adams visited the core lab at OSU to study the cores that Kulm's students had taken many years before to test his hypothesis that these turbidites had been triggered by great earthquakes.

Adams found that three of the cores taken along the length of the Cascadia deep-sea channel contained thirteen turbidites deposited since the eruption of Mazama Ash (Figure 4-7). Other cores from Juan de Fuca submarine canyon, below the confluence of several submarine canyons carving the continental slope off Washington, had the same number of turbidites above the Mazama Ash as in these canyons upstream from the confluence (inset, Figure 4-5). If turbidites in the upper canyons had been deposited by local events limited to an individual stream flood, the Juan de Fuca Canyon should have contained a much larger number of turbidites because they would all have collected downstream past the confluence. This convinced Adams that the turbidites had not been triggered by a local event within a single canyon but a regional event that affected the entire Washington and Oregon offshore as far south as the Rogue River



submarine canyon (which also had thirteen turbidites above the Mazama Ash).

Chris Goldfinger and Hans Nelson continued the study of the turbidites, collecting additional cores and subjecting them to radiocarbon dating. They dated the shells of microscopic organisms within the layers of fine-grained sediment that rained down into the canyons, clay that was interrupted by each turbidite (Figure 4-8). As in other paleoseismological work, they could not date the turbidite directly, and thus the earthquake that generated it. The turbidite would be dated only as younger than one fine-grained sediment layer and older than another.

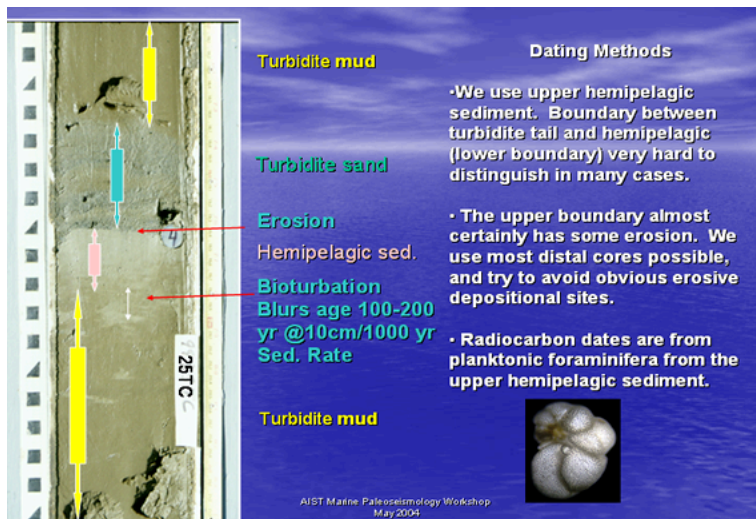

Figure 4-8. Earthquake-generated Cascadia turbidity-current deposit. The cores are dated using microfossils from the fine-grained hemipelagic layer, deposited between successive turbidites. Image courtesy Chris Goldfinger.

Because thirteen turbidites had accumulated in the 7,700 years since the eruption of Mt. Mazama in most of the submarine channels (some channels had fewer turbidite layers), Adams had been able to determine the average recurrence interval of Cascadia turbidites as about six hundred years. Goldfinger and Nelson were able to confirm this recurrence interval using the large number of radiocarbon dates they obtained and, in addition, to date older turbidites back to ten thousand years ago. Just as a consistent thirteen turbidites had accumulated since the Mazama Ash, eighteen turbidites (Figure 4-9) had been deposited in the past ten thousand years, a recurrence interval of more than five hundred and fifty years. The presence of thirteen post-Mazama turbidites in the Juan de Fuca, Cascadia, Willapa, Grays, Astoria, and Rogue canyons demonstrated to Goldfinger and Nelson that all turbidites had been deposited by events that had affected most, if not all, of the Cascadia Subduction Zone. The only trigger that made sense was a subduction-zone earthquake affecting the entire Washington and Oregon offshore.

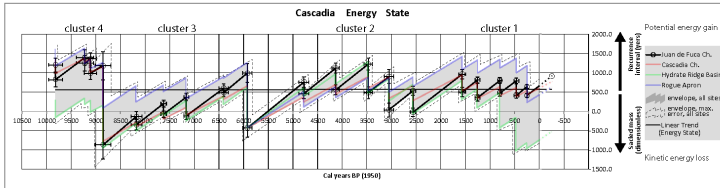

Figure 4-9. Ten thousand years of earthquakes on the Cascadia Subduction Zone. Vertical line represents size of earthquake based on the turbidite deposit formed by it. Horizontal position is based on radiocarbon ages of microfossils in fine-grained mud deposits overlying and underlying each turbidite. Note that some subduction-zone earthquakes were larger than the most recent earthquake in AD 1700.

Figure 4-9 identifies Cascadia earthquakes that have occurred in the past 10,000 years based on the turbidite evidence illustrated in Figures 4-6, 4-7 and 4-8. It is clear from Figure 4-9 that earthquake recurrence is not periodic, meaning that the earthquake history does not have value in predicting the next one except in a very general way. Earthquake recurrence intervals vary from 200 years to more than a thousand years. In addition, the earthquakes varied in magnitude, with the largest events 5900 and 8800 years ago, considerably larger than the magnitude 9 earthquake dated at 1700 A.D. (Figure 4-9) and described in greater detail below.

## 2. Earthquakes in the Estuaries



*Figure 4-10a. Niawiakum estuary in Willapa Bay, Washington, at very low tide, showing roots of a coastal forest drowned by sudden subsidence during earthquakes in 1700 AD and around 1600 years ago. Photo by Brian Atwater, USGS. b. Same exposure examined by paleoseismologist Jim McCalpin. Forest is similar to living forest in background. Photo by Robert Yeats.*



---

*with  
fossils  
was  
deposited  
on top.  
Photo by  
Brian  
Atwater,  
USGS.*

---



Figure 4-11. Dead forest of western red cedar sticking up through a brackish-water tidal marsh at Copalis River on the Washington coast. The forest was killed during rapid subsidence accompanying the most recent Cascadia Subduction Zone earthquake. Tree rings from the dead trees provide evidence that the trees died sometime after the end of the A.D. 1699 growing season and before the beginning of the A.D. 1700 growing season. This age is consistent with the date of this earthquake based on a Japanese tsunami, discussed below. The forest in the background is above the highest tides. Photo by Brian Atwater, USGS

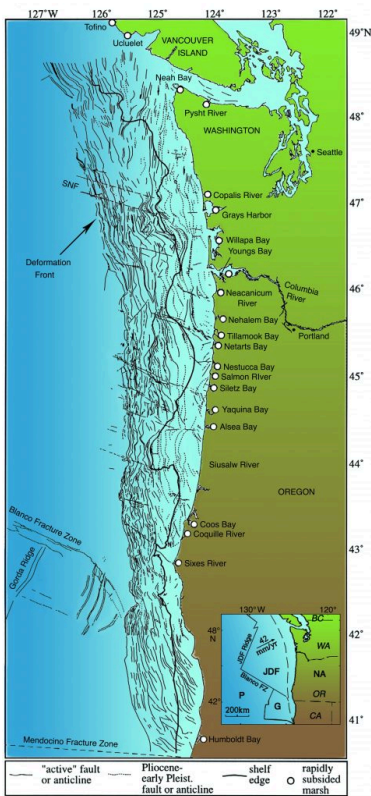

Figure 4-12. The Pacific Northwest coast locating sites of coseismic subsidence on the coast from Vancouver Island to northern California (open circles). From Sixes River to Vancouver Island, subsidence is due to subduction-zone earthquake. Subsidence at Humboldt Bay is related to crustal faulting (see Chapter 6). Active offshore faults and folds are also shown. Heavy line is the edge of the continental shelf. Image courtesy of Lisa

It was in the bays and estuaries along the coastline that the most conclusive evidence for great earthquakes was found by Brian Atwater and his American and Canadian colleagues, as stated in the Introduction (Figures 4-10a, b, 4-11). From Port Alberni, at the end of a deep fjord on the west coast of Vancouver Island, to Sixes River in southern Oregon, and at many bays and estuaries in between (Figure 4-12), the sediments give evidence of sudden drops in the land level. The marshes and forests were found to be overlain directly by gray clay with marine microfossils (Figure 4-10), which Atwater could explain only by sudden subsidence of the coastline. Some of these



McNeill of Southampton  
University and Chris  
Goldfinger of OSU.

drops appeared to have  
been accompanied by  
great waves from the sea  
that deposited sand on

the marsh deposits (Figure 8-12). The last of these waves struck about three hundred years ago. Atwater's explanation was the catastrophic explanation: great earthquakes on the subduction zone.

Scientists from Japan, England, and New Zealand, including specialists in the ecology of marshes and estuaries, critically scrutinized this evidence to look for defects in Atwater's earthquake hypothesis and to search for another, less apocalyptic, explanation. They were unable to find support for a non-seismic explanation for any of seven marsh soils buried at Willapa Bay in southwest Washington. For some of the buried marsh deposits, however, the evidence is ambiguous. These could have other origins such as gigantic Pacific storms or changes in the configuration of the estuary itself. But all soon agreed that the burial of marshes that took place three hundred and sixteen hundred years ago, at least, was caused by sudden submergences of the coast at the time of two great Cascadia earthquakes (Figure 4-10 and 4-11). Later, other burials would also be blamed on earthquakes.

### 3. The Bad News

The new discoveries went against the long-held view that the Cascadia Subduction Zone was not a seismic hazard. Most subduction zones around the world are shaken by frequent earthquakes, some of magnitude 9 or greater. But not Cascadia, which has been as seismically quiet as Kansas. At first, it was believed that the apparent absence of recorded earthquakes might be because the Juan de Fuca Plate is no longer subducting beneath North America. The eruption of Mt. St. Helens on May 18, 1980, was a dramatic demonstration that subduction is still going on.

Then it was suggested that the absence of recorded earthquakes is due to relatively few seismographs in the Pacific Northwest. But in the last thirty years, the University of Washington, the USGS, and the Geological Survey of Canada have deployed an extensive network of seismographs throughout the region. This sophisticated network recorded many earthquakes in the continental crust and within the subducting Juan de Fuca Plate, but almost none precisely on the subduction zone itself (Figure 4-13, left). Are land-based seismic network sensitive enough to record smaller earthquakes on the subduction zone?

In the past decade, the U. S. Navy has opened access to the hydrophone arrays it had established to monitor enemy submarines by recording the sound waves from their engines. These hydrophone arrays record not only

submarine-engine noise, but also record volcanic activity at sea-floor spreading centers, whale calls—and earthquakes. Research by Bob Dziak and his colleagues at NOAA shows that SOSUS arrays reveal unprecedented details about the seismicity of the Juan de Fuca spreading ridge and other sea floor features. But even at those listening levels, the subduction zone remains quiet (Figure 4-13, right). Why?

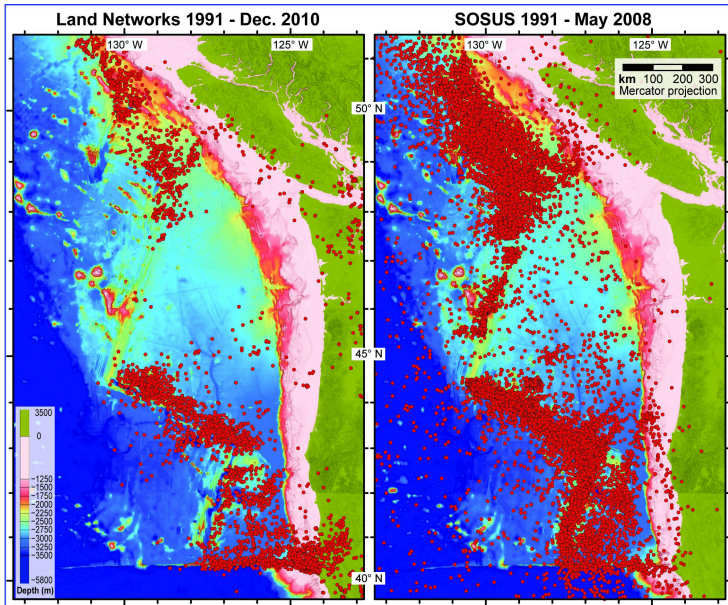

Fig. 4-13. Seismicity of the offshore Pacific Northwest and Vancouver Island based on land networks of seismographs (left) and a highly-sensitive hydrophone array (Sound Surveillance System, or SOSUS) that transmits sound through the water column (right). Even at this sensitivity, the Cascadia Subduction Zone is not generating earthquakes in the region between southern Vancouver Island and northern California. The large number of earthquake off northern Vancouver Island are on the Explorer Plate; much of the Gorda Plate is seismically active due to internal deformation. But not the subduction zone. From Bob Dziak, NOAA and OSU.

For a long time, it was thought (perhaps “hoped” is a better word) that the absence of earthquakes meant that the slippery subduction zone slides smoothly beneath the continent. Subduction without

earthquakes was still being suggested in a paper in a major scientific journal as recently as 1979. But in 1980, as mentioned in the preceding chapter, Jim Savage of the USGS and his colleagues began repeated measurements of networks of surveying benchmarks around Seattle, in Olympic National Park (Figures 3-19, 3-20), and the Hanford Nuclear Reservation. Their conclusion: these networks show that the crust is being slowly deformed in a way that is best explained by elastic strain building up in the crust, like the examples in Figures 3-2 and 3-3. The obvious source of this strain: the Cascadia Subduction Zone. The reason that there have been no earthquakes on the subduction zone is an ominous one: the subduction zone is locked. *Completely locked!* If this is the case, then strain must ultimately build up along the subduction-zone fault, inexorably, at 1.6 inches per year, until eventually the subduction zone will rupture in a massive earthquake.

At about the same time (as already reported in the Introduction), John Adams, then of Cornell University, was studying the resurveys of highway benchmarks and discovering that the coastal regions of Oregon and Washington are being slowly tilted eastward. A few years later, Heaton and Kanamori showed that the geophysical setting of Cascadia is like that of southern Chile, where the largest earthquake of the twentieth century struck in 1960. A short time after that, in 1986, Brian Atwater paddled up the Niawiakum River estuary in his kayak and discovered the submerged marshes and forests of Willapa Bay (located in Figure 4-10).

For about ten years, starting in the late 1970s, the argument raged among scientists about whether or not the Cascadia Subduction Zone poses an earthquake threat, triggered by a major economic and political issue: was it safe to build and operate nuclear power plants in western Washington and Oregon and northern California? Proponents of the big-earthquake hypothesis were led by scientists of the USGS, influenced by geodesists such as Jim Savage who were re-surveying benchmarks, and later by geologists like Brian Atwater. As described in the Introduction, it was only in 1987 that the controversy was finally resolved at the Oregon Academy of Sciences meeting in Monmouth, Oregon, where it was recognized that the paradigm change had occurred, at least among scientists. Most of the leading Cascadia earthquake researchers agreed at this meeting that the Cascadia Subduction Zone does indeed pose a major earthquake threat. When a paradigm change takes place, particularly for a topic that has such an impact on society, scientists take on a new mission: to inform the general public of the consequences and implications of this new discovery. This book is part of that mission.

Even though there was general agreement that there would be huge earthquakes on the Cascadia Subduction Zone, a new debate began over how big the expected earthquake would be. Would it be of magnitude 8 or 9? This difference is not, as some have suggested, analogous to being struck by a tractor-trailer or a compact car!

Although there is agreement that the absence of seismicity on the subduction zone cannot be used as evidence for an absence of subduction-zone earthquakes, the question arises: why does Cascadia lack any seismicity on the subduction zone itself? Figure 4-13 shows that the northern and southern ends of the subduction zone in the Explorer and Gorda plates have seismicity, probably due to internal plate deformation. In addition, the southern end of the subduction zone was struck by an earthquake of magnitude 7.1 on April 25, 1992. Only the central part between southern Vancouver Island and northern California lacks seismicity on the subduction zone. Ivan Wong, a consulting seismologist with Oregon roots, examined this problem and pointed out that the only part of the subduction zone that lacks earthquakes contains a huge slab of basalt crust many kilometers thick called Siletzia. This thick slab serves as an insulator against the high temperatures of young incoming crust of the Juan de Fuca Plate. Is this why there are no earthquakes on the subduction zone in this part of Cascadia? This problem needs further work, and I return to it later in the chapter.

## 4. Instant of Catastrophe or Decade of Terror?

After Atwater's discovery at Willapa Bay, other scientists found evidence of marshes buried by sudden subsidence accompanying earthquakes at South Slough near Coos Bay in southern Oregon, at Salmon River near Lincoln City, Oregon, at Nehalem Bay and Netarts Bay in northern Oregon, at the mouth of the Copalis River in Washington, and at Port Alberni and Ucluelet on the Pacific coast of Vancouver Island (Figure 4-12). Carbon from buried soils and from drowned tree trunks was sent to radiocarbon labs for dating. The result: the youngest marsh burial occurred about three hundred years ago at nearly all sites along the Cascadia Subduction Zone from British Columbia to southern Oregon. If this was caused by a single earthquake, as the similarity in radiocarbon ages would suggest, that earthquake would have a moment magnitude ( $M_w$ ) of 9, close to the size of the great Alaskan earthquake of 1964. It would rank among the largest ever recorded.

A common saying among geologists is that *what has happened, can happen*. If the earthquake three hundred years ago was a magnitude 9, the next subduction-zone earthquake could also be a 9. If this were to happen, what would be the impact on our society?

All of western Washington and Oregon, southwesternmost British Columbia, and Del Norte and Humboldt counties in north-coastal, California would



be devastated by a magnitude 9 earthquake, so that emergency response teams would have to come from inland cities or from central and southern California. Intense shaking from a magnitude 9 event would last two to three minutes or longer; a magnitude 8 event would have strong shaking for about half that time. A building might survive strong shaking lasting a minute, but not two or three times as long. For comparison, the strong shaking for the Kobe and Northridge earthquakes each lasted less than thirty seconds. Some of the shaking during these smaller earthquakes was as strong as that expected for a great subduction-zone earthquake; it just didn't last as long.

This shaking would trigger landslides throughout the Coast Range, Olympic Mountains, and Vancouver Island, in Puget Sound and the Willamette Valley, and even on the continental slope, where landslides could trigger tsunamis. For even a magnitude 8 event, large sand bars like those at Long Beach, Washington, or at the mouth of Siletz Bay, Oregon, could become unstable, as would low-lying islands in the tidal reaches of the lower Columbia River. The Pacific coastline would drop permanently, as shown in Figures 4-10 and 4-11, as much as two to four feet, inundating low-lying areas such as Coos Bay, Yaquina Bay, Siletz Bay, Tillamook Bay, Cannon Beach, Seaside, and Astoria, Oregon, and Long Beach and Grays Harbor in Washington.

Seismic sea waves, or tsunamis, could be as high as thirty to forty feet with a magnitude 9 earthquake, but

less than half that with an 8. Fifteen to thirty minutes after the mainshock had died away, the first of several tsunami waves would strike. In some cases, the water would first rush out to sea, exposing sea floor never before seen as dry land, but a short time later, a wall of water would rush inland, sweeping the sand from barrier bars inland, overwhelming beach houses and bayfront boutiques and restaurants as far as several blocks away from the sea. These destructive waves would be repeated several times.

The mainshock would be followed by aftershocks, some with magnitudes greater than 7, large earthquakes in their own right. These aftershocks would continue at a diminishing rate for many years. For a magnitude 8 earthquake, aftershocks would affect a limited part of the Pacific Northwest perhaps two to three hundred miles long, but for a magnitude 9 event, the entire Northwest from Vancouver Island to northern California would be shaken.

Because a magnitude 9 earthquake would devastate such a large area, it would have catastrophic effects on the economy of the Northwest, the ability of government to serve the people, and the ability of insurance companies to pay their claims. The economic effects of a magnitude 8 event would be great, but not as cataclysmic as those of a magnitude 9 because a much smaller area would be affected. If a magnitude 8 earthquake originated west of the mouth of the Columbia River, it would severely damage the Portland metropolitan area, but would have lesser effects on the

cities of Puget Sound or the southern Willamette Valley. Emergency response teams from those areas could come to the aid of Portland and adjacent communities in Oregon and Washington. There would be less damage, fewer insurance claims, less destructive effects on the overall economy of the United States and Canada than from a magnitude 9 earthquake. I return to the effects on society in a later chapter.

A diagram illustrating the buildup and release of strain in the next great Cascadia earthquake is shown as Figure 4-14.



*A video element has been excluded from this version of the text. You can watch it online here:*

<https://open.oregonstate.education/earthquakes/?p=94>

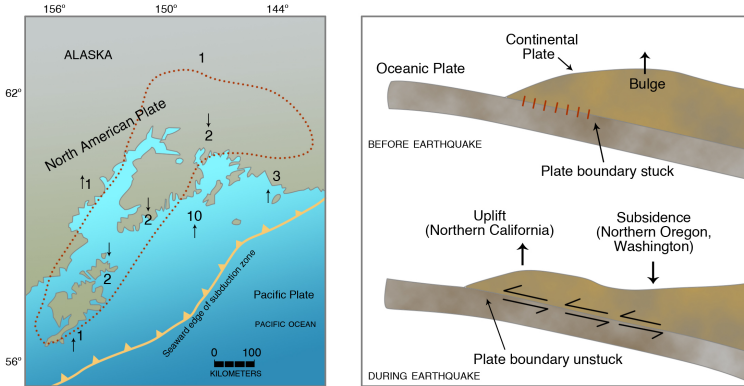

Figure 4-14. (Right) Cross section showing buildup of elastic strain in North American continental edge before an earthquake, then sudden release (elastic rebound) during earthquake, causing the outermost part of upper plate to go up and an inner part to go down. The Vancouver Island, Washington, and Oregon coast should go down and the northern California coast should go up, according to this model. Modified from Brian Atwater, U.SGS. (Left) Map of part of southern Alaska, showing parts of the crust that went down in the great 1964 earthquake (Mw 9.2) and parts that went up. Numbers show subsidence (down arrows) or uplift (up arrows) in meters. Uplift and subsidence accompanying this earthquake were used to model uplift and subsidence accompanying a Cascadia Subduction Zone earthquake. Images courtesy of Chris Goldfinger, College of Earth, Ocean, and Atmospheric Sciences, OSU.

How do we learn whether the last earthquake was a magnitude 8 or a 9? Radiocarbon dates can provide accuracy to within a few decades, which is not proof that all the marshes and estuaries were buried at the same time from Vancouver Island to southern Oregon. In southwest Japan, the Nankai Subduction Zone broke

in two magnitude 8 earthquakes, one in 1944, while Japan was in the throes of World War II, and one in 1946, when the country was trying to rebuild after the end of the war. If these earthquakes had not been recorded historically, radiocarbon dating could not have provided evidence that these were two separate earthquakes; the numbers could just as likely have documented one great earthquake rather than the two that actually occurred. Gary Carver of Humboldt State University points out the dilemma: one gigantic earthquake (“instant of catastrophe”) versus a series of smaller ones (“decade of terror”) about three hundred years ago.

Tree-ring dating can get closer to a true date than radiocarbon dating can (Figure 4-15. Gordon Jacoby of Columbia University and Dave Yamaguchi of the University of Washington compared the pattern of growth rings of trees killed in several estuaries in southwest Washington. Variations in the growth patterns of trees from year to year, related to unusual wet seasons or drought years, allowed these scientists to use radiocarbon dating to conclude that trees in four of these estuaries were inundated some time between August 1699 and May 1700, strong evidence that the estuaries were downdropped at the same time by an earthquake of magnitude greater than 8. However, at that time, these correlations had not been extended north to Vancouver Island or south to California, which

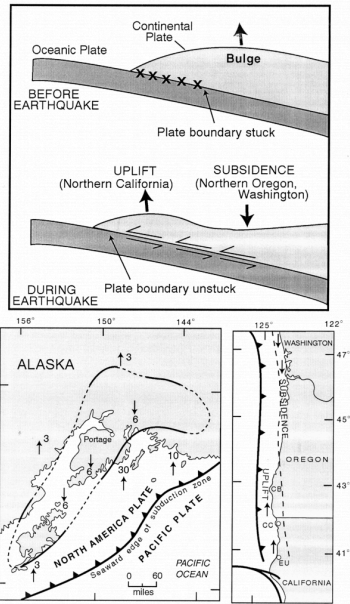

Figure 4-15. Dating earthquakes in coastal estuaries, from Gordon Jacoby, Columbia University. Bands indicate width of individual annual tree rings, which have been correlated and dated by  $^{14}C$ . The victim tree grew close to sea level and was killed when the ground subsided during a great earthquake. Radiocarbon dating can determine the age to within a few decades.

would strengthen the case for a single magnitude 9 earthquake.

Clifton Mitchell and Ray Weldon of the University of Oregon studied re-levelings of U. S. Highway 101 along the coast from Crescent City, California, to Neah Bay, Washington, taking advantage of a more accurate leveling survey carried out after John Adams had published his results. They found that over the past fifty years, southern Oregon, the mouth of the Columbia River, and northwest Washington have been rising at about an inch or more every ten years (Figure 4-16, map on left side). But the central Oregon coast around Newport and the area around Grays Harbor, Washington, are hardly uplifting at all. This suggested to them that only some parts of the Cascadia Subduction Zone are building up elastic strain. Imagine irregular hang-ups or strong points (called *asperities*) along the subduction zone that concentrate all the strain and localize the uplift, separated by other regions where strain is not accumulating. The zones of little or no strain around Newport and Grays Harbor could have terminated the rupture, preventing it from shearing off the next asperity to the north or south. This line of reasoning supported the “decade of terror” hypothesis of several smaller earthquakes rather than one humongous one.

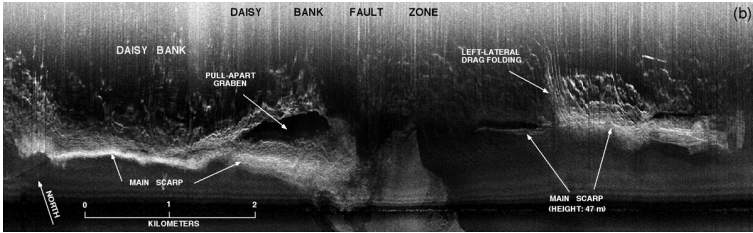

Figure 4-16. Map of the Cascadia Subduction Zone showing contours of uplift in the past fifty years in millimeters, from C. Mitchell and R. Weldon, University of Oregon (left) and from R. Hyndman and K. Wang, Pacific Geoscience Centre (right). Mitchell and Weldon showed the complexities of the data based on releveling highways in western Oregon and Washington, supporting a smaller maximum earthquake on the subduction zone. Hyndman and Wang, on the other hand, smoothed out the data to fit their idea that the maximum earthquake could be of magnitude 9. Faults and folds crossing the subduction zone and adjacent North America Plate led R. McCaffrey and C. Goldfinger to suggest that the maximum earthquake would be much smaller than a magnitude 9. But the Japanese tsunami evidence favors a magnitude 9!

But Roy Hyndman and Kelin Wang of the Pacific Geoscience Centre at Sidney, B. C., argued that the earthquake is more likely to be a 9 rather than an 8. Using temperature estimates in the crust on Vancouver Island and offshore, they calculated which parts of the subduction zone would be stuck and which parts would slide freely due to higher temperature at greater depth. They also measured the changes in leveling lines across Vancouver Island and the Georgia Strait. They compared their leveling data with uplift of the land with respect to sea level, taking advantage of the fact



that they could use three coastlines: both sides of Vancouver Island and the mainland coast northwest of Vancouver. Hyndman and Wang calculated where the brittle-ductile transition would be, together with a deeper transition zone that would be brittle under rapid strain and ductile under slow strain (like Silly Putty). This can be seen in Figure 2-1, except that the brittle-ductile transition would be along the subduction-zone fault itself. Their model predicted that the next great earthquake would rupture the entire subduction zone from Canada to California, a magnitude 9 rather than an 8 (Figure 4-16, right-hand map).

Chris Goldfinger had long been an advocate of the smaller-earthquake hypothesis. However, his study of the Holocene turbidites convinced him otherwise. There are the same number of turbidites in Rogue River submarine canyon off southern Oregon as there are in the submarine canyons off the coast of Washington, which provided support for an earthquake of magnitude 9. However, further dating of turbidites showed that some turbidites were limited to the southern part of the subduction zone, evidence that some of the subduction-zone earthquakes were limited to the southern part of the subduction zone. This means that the recurrence interval estimated for subduction-zone earthquakes in southern Oregon and northern California would be shorter than for magnitude 9 earthquakes rupturing the entire subduction zone. Goldfinger suggests that the average

recurrence interval for smaller southern Cascadia earthquakes has already exceeded the historical record.

Additional evidence for the most recent earthquake came from Japan.

## 5. A Japanese Tsunami from Cascadia: A Detective Story

The difficulty in figuring out the maximum size of a Cascadia earthquake, of course, is the lack of local historical records at the time the last great subduction-zone earthquake struck the Pacific Northwest. But there is one last chance. Suppose the earthquake generated a tsunami that was recorded somewhere else around the Pacific Rim where people *were* keeping records. This leads us to Japan, the first country on the Pacific Ring of Fire to develop a civilization that kept written records.



A video element has been excluded from this version of the text. You can watch it online here:

<https://open.oregonstate.education/earthquakes/?p=94>

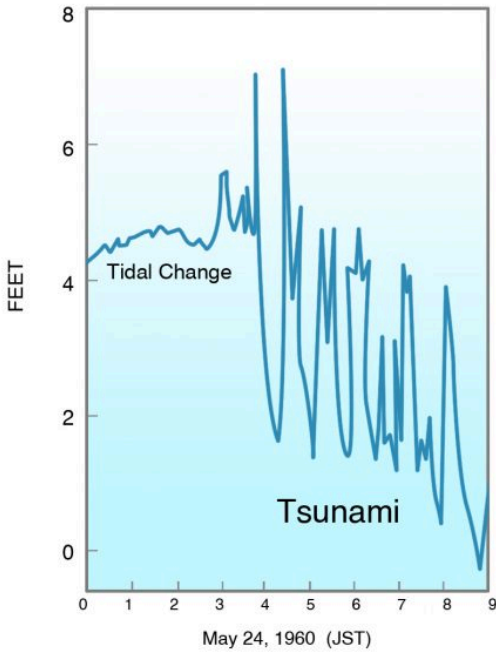
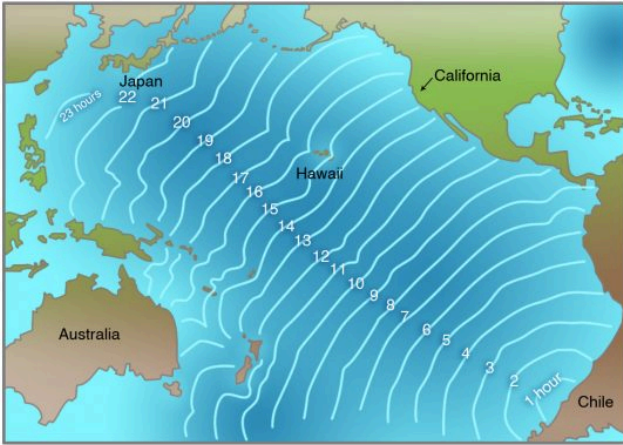

Figure 4-17. (Top) Wave fronts of tsunami accompanying the 1960 Chilean Earthquake (Mw 9.5) in hours, as tsunami crossed Pacific. (Bottom) Tide gauge record of 1960 tsunami recorded at Miyako, Japan, in hours. From K. Satake, University of Tokyo.

---

In May 1960, an earthquake of moment magnitude 9.5, the greatest earthquake of the twentieth century, struck the coast of southern Chile. This earthquake generated a large tsunami that traveled northwestward across the Pacific Ocean and struck Japan twenty-two hours later, causing one hundred forty deaths and great amounts of damage (Figure 4-17). Cascadia is closer to Japan than Chile, and if a magnitude 9 earthquake ruptured the Cascadia Subduction Zone, a resulting tsunami might have been recorded in Japan. The height of the tsunami wave might give evidence about whether the magnitude was 9 or only 8.

The southwestern part of Japan, closer to the ancient civilization of China, developed first, and its first local subduction-zone earthquake was recorded in A.D. 684. Records of earthquakes, tsunamis (*tsunami* is derived from the Japanese characters for “harbor wave”), and volcanic eruptions were kept at temples and villages, principally in southwest Japan until A.D. 1192, when the government was moved to the fishing village of Kamakura on Tokyo Bay, leaving the emperor in isolated splendor far to the west, in Kyoto. In A.D. 1603, the

Tokugawa rulers moved the administrative capital farther north to Edo, another small outpost which would become the modern capital of Tokyo. By this time, the entire Pacific coast of Honshu, which faces Cascadia, had been settled, and written records were being kept throughout Japan.

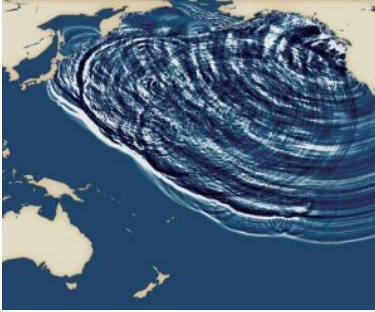

*Figure 4-18. Computer model of Cascadia subduction-zone earthquake, from Kenji Satake and his colleagues at the University of Tokyo.*

At the time, the Japanese did not necessarily make a connection between earthquakes and tsunamis, but compilation of these ancient records by Japanese scientists and historians in recent years shows that most of the tsunamis recorded from

the earliest times were related to the great subduction-zone earthquakes that frequently struck the Japanese Home Islands. But a few tsunamis did not accompany a local earthquake. Japanese investigators were able to correlate most of these mysterious “orphan” tsunamis to subduction-zone earthquakes in South America, where local records were kept. Earthquakes in Peru in A.D. 1586 and 1687, before the Cascadia earthquake, and in Chile in A.D. 1730 and 1751, after the event, produced tsunamis that were recorded in Japan.

But Kenji Satake, then at the University of Michigan and now at the University of Tokyo, found records

written in classical Japanese for one tsunami that could not be correlated to a local Japanese earthquake and had no apparent source in other subduction zones around the Pacific where records were kept, including South and Central America and the Kamchatka Peninsula north of Japan. On January 27 and 28, A.D. 1700, this tsunami produced waves as high as nine feet that were recorded at six different coastal sites on the main island of Honshu (Fig. 4-19) from the far north, near Hokkaido, to the Kii Peninsula south of Kyoto, still the imperial capital of Japan. Houses were damaged, and rice paddies and storehouses were flooded. The distribution of recording sites along most of the Pacific coast of Honshu ruled out a local source of the tsunami, such as a submarine landslide or volcanic eruption. This became known as the “orphan” tsunami, a tsunami without an earthquake source.

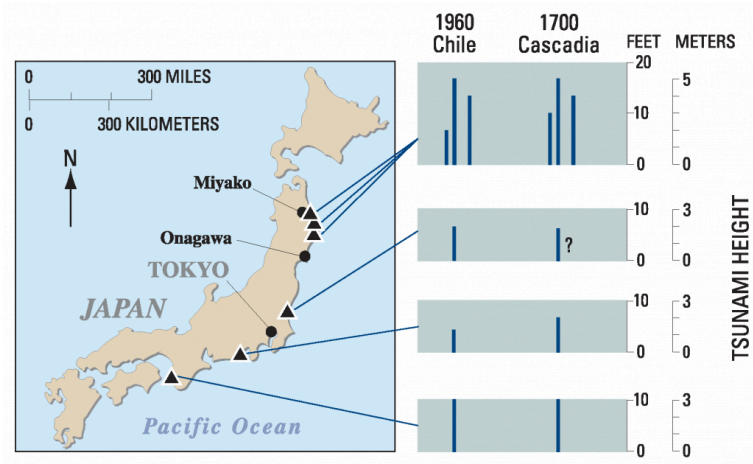

Figure 4-19. Computer model of the tsunami resulting from a great earthquake on the Cascadia Subduction Zone on January 26, A.D. 1700. The tsunami has already reached southern Alaska, and the first wave is about to reach the Hawaiian Islands. Japan is at far left. Note how far individual waves are separated from one another, and how high the waves are west of Cascadia, in the direction of seismic wave propagation, compared to waves off Baja California, at lower right. As shown by wave heights observed in Japan, subduction-zone earthquakes in Chile and Cascadia have caused tsunamis that were large even after crossing the Pacific Ocean. From K. Satake, University of Tokyo.

At an earthquake conference at Marshall, California, in September 1994, Satake was having lunch with Alan Nelson of the USGS. Nelson had been worrying about whether buried marshes at Coos Bay, Oregon, had been downdropped by earthquakes or by some other means. He explained to Satake that subsided marshes along the Northwest coast from Vancouver Island to southern Oregon had all been radiocarbon dated as about three



hundred years old. These dates could not be pinned down closer than a few decades around A.D. 1700 because of limitations in the radiocarbon and tree-ring dating methods (Fig. 4-15). Could the Japanese tsunami of that year have been the result of a great Cascadia earthquake?

First, Satake and his Japanese coworkers had to exclude all other subduction zones around the Pacific Rim that, like Cascadia, were not settled by people keeping records in A.D. 1700, for example, Alaska and the Aleutian Islands. But the great 1964 Alaska Earthquake of M 9.2, the second largest earthquake of the twentieth century, had generated only a very small tsunami in Japan, although, as will be seen in Chapter 9, it produced a destructive tsunami in the Pacific Northwest. This was due to the orientation of the Aleutian Subduction Zone, which is parallel to Japan rather than perpendicular to it, so that the largest tsunamis were propelled to the south and southeast, away from Japan. The Kamchatka-Kurile Islands Subduction Zone was another possibility, but explorers and traders were there as early as the 1680s, and again, the orientation of the subduction zone was parallel to Japan. By process of elimination, this left Cascadia.

Could the tsunami have been caused by a local typhoon? The records for the day of the tsunami show that central Japan had sunny or cloudy weather and was not visited by a storm. In addition, even a gigantic “storm of the century” should have produced a more localized distribution of tsunamis than was observed.

A monster typhoon could have struck all the recording sites, but not all at the same time. It would have swept along the coast from south to north, or from north to south. In addition, most typhoons in Japan strike during the summer months, and would be most unusual in January.

Satake knew how fast tsunamis travel in the open ocean, about the speed of a commercial jetliner. By backtracking the tsunami across the Pacific to the Cascadia coastline, he calculated that if the earthquake generating the tsunami had come from Cascadia, it would have struck about 9 p.m. on January 26, 1700. Satake's computer model of a Cascadia tsunami on its way to Japan is shown in Figure 4-18. In addition, his computer model showed that the tsunami wave heights recorded in Japan had to have come from an earthquake of magnitude 9. In addition, there was only one set of tsunami waves (instant of catastrophe), not several, as there would have been if the Cascadia Subduction Zone had been ruptured by a series of smaller earthquakes over several years (decade of terror).

## **6. Native Americans Were Making Observations, After All**

Could there be confirmation in the oral traditions of Native Americans living along the coast at that time?

Garry Rogers of the Pacific Geoscience Centre in Sidney, B.C., found in the provincial archives at Victoria a tradition that an earthquake had struck Pachena Bay on the west side of Vancouver Island during a winter night. It was discovered the following morning that the village at the head of the bay had disappeared. This is consistent with Satake's calculated time of the earthquake based on the Japanese tsunami. Traditions of the Chinook included references to ground shaking. The Makah, Tillamook, and Coos tribes have stories of the inundation of coastal settlements by "tidal waves" or tsunamis.

Gary Carver's wife, Deborah Carver, has collected stories recorded in the early part of the twentieth century from Wiyot, Yurok, Tolowa, and Chetco bands living on the coast of northern California and southern Oregon (see Yurok oral history at the beginning of this chapter). Many of these stories tell of strong shaking from a great earthquake along at least two hundred miles of coastline, followed by many aftershocks, liquefaction of sediments, subsidence of coastal regions, and tsunamis that lasted for several hours. Six of these stories indicated that the earthquake struck at night. The earthquake and tsunami destroyed many villages and drowned many people living there. Carver reported that one purpose of the Yurok "Jumping Dance" was to repair or re-level the Earth after an earthquake.

The story that follows is from an interview recorded by A. L. Kroeber in his book *Yurok Myths*:

*And from there [Earthquake and Thunder] went south—They went south first and sank the ground—Every little while there would be an earthquake, then another earthquake, and another earthquake—And then the water would fill those [depressed] places—”That is what human beings will thrive on,” said Earthquake. “For they would have no subsistence if there were nothing for the creatures [of the sea] to live in. For that is where they will obtain what they will subsist on, when this prairie has become water, this stretch that was prairie: there will be ocean there.”—”Yes, that is true. That is true. That is how they will subsist,” said Thunder. “Now go north.” Then they went north together and did the same: they kept sinking the ground. The earth would quake and quake and quake again. And the water was flowing all over.*

This story spoke of land that sank into the ocean during an earthquake—exactly what Brian Atwater, Alan Nelson, and Deborah’s husband, Gary, had concluded from their study of marsh deposits on the Pacific coast. In addition, Gary Carver studied a subsidence site in northern California and concluded that the subsidence occurred after the leaves had fallen and before new growth appeared on the trees; that is, probably during the winter.



A video element has been excluded from this version of the text. You can watch it online here:

<https://open.oregonstate.edu/earthquakes/?p=94>

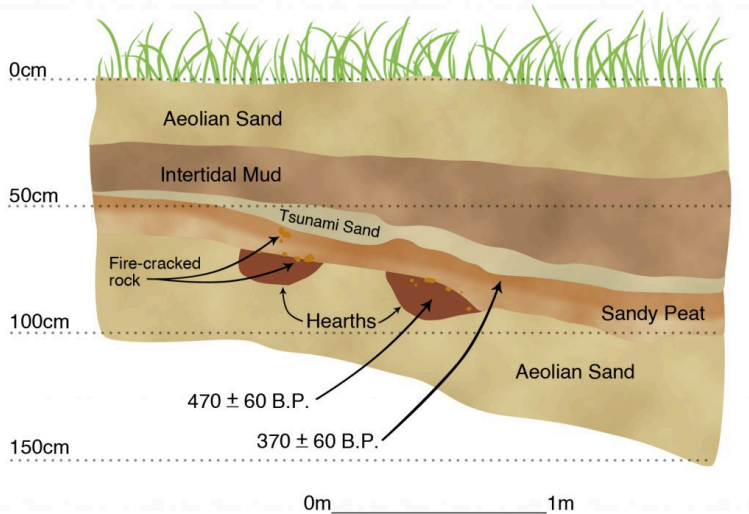

Figure 4-20. Cross section of buried Native American campsite (hearths, fire-cracked rock) overlain by a soil zone submerged by the A.D. 1700 Cascadia Subduction Zone earthquake and covered by a tsunami deposit. From Minor and Grant (1996); drawing courtesy of Rick Minor, Heritage Research Associates, Eugene, Oregon.

Rick Minor suggested that Cascadia Subduction Zone earthquakes might explain an oddity of Native American archaeology along the coast. Sea level rose rapidly from twelve thousand to five thousand years

ago, as glacial ice sheets melted, and then stabilized close to the present level four to five thousand years ago. But there is very little archaeological evidence for Native American settlement along the coast prior to about two thousand years ago. Could the lag in settlement be a result of abrupt coastal subsidence and great tsunamis accompanying past subduction-zone earthquakes? Were Native Americans more concerned about earthquake and tsunami hazards than we are today? Minor described one Native American site that is overlain by sand deposited by a tsunami (Figure 4-20).

## 7. M 8 or M 9? Where Do We Stand?

Participants in a scientific conference held at Seaside, Oregon, in June 2000 were asked their opinions on M 9 vs. M 8 for the 1700 earthquake. The vote was overwhelming for an earthquake of M 9, indicating that another paradigm change had taken place. The evidence from the Japanese tsunami of A.D. 1700 and the constant number of post-Mazama turbidites from submarine channels from southern Oregon to Washington confirmed the tectonic model of Hyndman and Wang and carried the day.

However, this does not mean that all the earlier earthquakes recorded in the estuaries were M 9 as well. Atwater and his colleague, Eileen Hemphill-Haley, found that some of the paleoseismic sites at Willapa Bay

recorded drowning of a coastal forest, whereas others recorded drowning of marsh grasses, evidence of less subsidence (Figure 4-21). If marsh grasses rather than forests were drowned, would this indicate a smaller earthquake, closer to M 8? So, even though scientists agree that the 1700 earthquake was M 9, earlier ones, and by inference, the next one, which is the main reason we are concerned about this, could be smaller. This is particularly true for that part of the subduction zone off the coast of northern California.

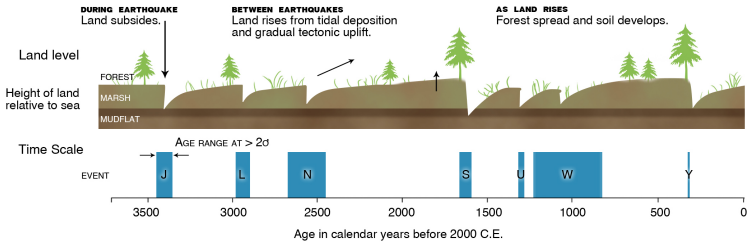

Figure 4-21. Evidence for earthquakes at Redtail locality at Willapa Bay, Washington. Horizontal line is time in years; vertical line is elevation with respect to sea level divided into coastal forest, marsh, and tidal mudflats. Heavy line shows change in elevation. Ground sinks abruptly to sea level after an earthquake, then gradually rises to a marsh environment or a forest environment. Letters identify earthquakes dated by radiocarbon, with the gray band representing uncertainty in dating. The youngest, event Y, is the earthquake of A.D. 1700, dated by tree rings and a tsunami in Japan. The time interval between earthquakes varies from nearly one thousand years between events N and S to less than three hundred years between events U and W. The longest interseismic intervals allowed the ground to develop forests before they were drowned by earthquakes S and Y, whereas earthquakes N, U, and W struck when the ground had only risen to develop a coastal marsh. The greater vertical drop for earthquakes J, S, and Y suggests that they may have been larger than earthquakes N, U, and W. After B. Atwater and E. Hemphill-Haley, USGS

## 8. Northern California: It's Not the Same South of the Border

The subduction zone in northern California is different from the rest of Cascadia. Off Oregon and Washington, it lies at the base of the continental slope, but in



northern California it turns toward the southeast and angles up the continental slope, headed for the Triple Junction of the North American, Pacific, and Gorda plates beneath the village of Petrolia (Figures 2-4, 4-22).

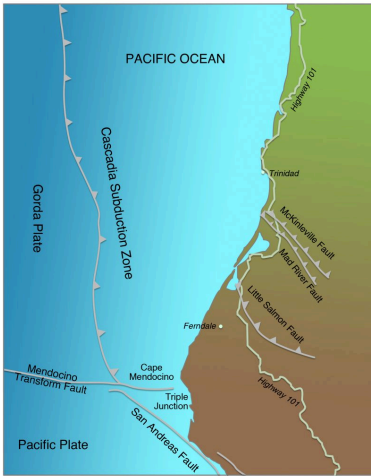

Figure 4-22. Computer-generated topographic map of California north coast showing the Triple Junction, the San Andreas Fault, the Mendocino Transform Fault, the Cascadia Subduction Zone, and active thrust faults onshore.

The southern end of the subduction zone apparently ruptured during the April 25, 1992, Cape Mendocino Earthquake of M 7.1, the only part of the subduction zone to have broken in an earthquake during the seismograph era. This earthquake caused \$64 million in damage; 202 buildings were destroyed, and 356 people were injured, although nobody was killed. Damage was limited because the high-intensity zones of VII-IX

were around small villages east of Cape Mendocino. The larger cities of Eureka and Arcata were farther away, and intensity was lower there.

The mainshock, a zone of shallow aftershocks, and GPS observations before and after the earthquake suggest that the earthquake produced ten to sixteen feet of slip on an east-dipping fault plane with the

mainshock at about six miles depth. There was no surface rupture onshore, although a fifteen-mile section of coastline was uplifted one to five feet, killing off a tide-pool community of barnacles, mussels, sea urchins, and coralline algae (Figure 4-23). Several kinds of evidence, including older marine terraces uplifted by prehistoric earthquakes and a comparison of slip in 1992 with the long-term convergence rate between the Gorda and North American Plates, give a recurrence interval for 1992-type earthquakes of a few hundred years, perhaps as low as one hundred and fifty to two hundred years. However, the prehistoric Holocene terraces were uplifted in a longer section of beach than the 1992 uplift, suggesting that the older earthquakes were larger.



Figure 4-23. Rocky platform on beach uplifted by the 1992 Cape Mendocino Earthquake on the Cascadia Subduction Zone. The platform is covered with bleached algae and shellfish killed by uplift of the platform. In northern California, where the subduction zone is close to the coast, coseismic deformation is by uplift, whereas in Oregon and Washington, it is by subsidence. Gary Carver included for scale. Photo by T. Dunklin, courtesy of Lori Dengler, Humboldt State University

This recurrence interval is about half as long as the recurrence interval of Cascadia earthquakes in Oregon and Washington based on buried marshes, and the M 7.1 earthquake is small compared to the M 8 or M 9 earthquake that is awaited by the rest of Cascadia. Should this part of the subduction zone expect earthquakes in the M 7.0 to 7.5 range rather than the monster event Satake envisioned in A.D 1700? For insight, we return to southwest Japan, where part of

the Nankai Subduction Zone comes ashore at the Izu Peninsula, just as the Cascadia Subduction Zone heads for the coast at Cape Mendocino. A long historical record in Japan shows that large earthquakes occur on the land part of the Nankai Subduction Zone at Izu Peninsula at intervals of seventy to eighty years, whereas the more typical part of the subduction zone is struck by earthquakes of M 8 or larger every one hundred to one hundred and fifty years. Some of the Izu earthquakes are M 6.5 to M 7.1, and in addition, some of the large M 8 events rupture across the peninsula as well as along the subduction zone at the base of the continental slope. This could explain the short recurrence interval near Cape Mendocino as well as the absence of the three-hundred-year buried marsh at some sites in Humboldt Bay. Some of the Mendocino earthquakes would be local, like the 1992 event, and some would rupture the entire subduction zone, like the 1700 event. However, at the moment, this is just a guess.

The shorter recurrence interval for earthquakes uplifting the marine terraces near Cape Mendocino is confirmed by the recurrence interval based on turbidites in the Trinidad, Eel, and Mendocino submarine channels, which is 133, 75, and 34 years, respectively. Earthquakes strike there more frequently, and they are more variable in their return times. This may be due to earthquakes on the San Andreas Fault south of Cape Mendocino or to crustal earthquakes on

active faults near the coast (Figure 4-22). Crustal faults are discussed further in Chapter 6.

The 1992 earthquake differed from the expected behavior of a subduction-zone earthquake farther north in another way: the shoreline was uplifted rather than downdropped. The explanation for this is seen in Figure 4-15. The subduction zone is much closer to the coastline in northern California than it is farther north, and thus it is in the area where uplift would be predicted, not subsidence. But what about the subsided marshes at Humboldt Bay (Figure 4-13)? These marsh burials are related to local crustal faults, not the subduction zone (discussed further in Chapter 6).

## 9. Recurrence Intervals and the Next Subduction Zone Earthquake

Atwater and Hemphill-Haley analyzed an earthquake record spanning 3,500 years at Willapa Bay in southwestern Washington, identifying seven earthquakes, including the A.D. 1700 event. As shown in Figures 4-9 and 4-21, these earthquakes struck at irregular intervals. At the Redtail site, events S, U, and W struck within a five-hundred-year interval, whereas about nine hundred years elapsed between Event S and the previous Event N. In the Sixes River estuary in southern Oregon, just north of Cape Blanco (located on

Figure 4-12), Harvey Kelsey, Eileen Hemphill-Haley, and their colleagues found evidence for eleven earthquakes in the past 5,500 years, with variation in time between events from seventy years to as much as nine hundred years. Goldfinger found turbidites triggered by thirteen earthquakes since the eruption of the Mazama Ash 7,700 years ago and eighteen earthquakes since the beginning of the Holocene about ten thousand years ago. The shortest time between post-Mazama turbidites is 215 years and the longest time nearly fifteen hundred years.

The average recurrence interval at Willapa Bay and Sixes River is 500-540 years, but it is not clear that there is a one-to-one correlation between earthquakes at the two sites. Kelsey and his colleagues suggested that an earthquake two thousand years ago at Sixes River lacks a counterpart at Willapa Bay. The average recurrence interval based on post-Mazama turbidites is six hundred years, and for the entire Holocene it is 550-560 years. At Bradley Lake, north of Sixes River, the recurrence interval is about 440 years. But Alan Nelson of the USGS and his colleagues found that two earthquake-related deposits at Bradley Lake were separated by only forty years, suggesting that Bradley Lake was affected by smaller earthquakes to the north and south.

These studies reveal a paleoseismic record that is unparalleled anywhere else in the world. But until individual earthquakes are more closely dated by radiocarbon, about all that can be said at the present

time is that north of California, the number of earthquakes is about the same for all earthquake sequences studied, and that repeat times for individual earthquakes are highly variable. As yet, we are far from being able to predict how long it will be until the next earthquake. One idea is that the longer the time since the last earthquake, the larger the next one is likely to be. If the next Big One happened tomorrow, a little more than halfway through the average recurrence interval, the earthquake would be smaller than the 1700 event because less strain would have accumulated. A suggestion that this might be the case can be inferred from the Willapa Bay record at the Redtail site (Figure 4-21). Events N and W were followed by long periods with no earthquakes, and the earthquakes that followed (Events S and Y, respectively) recorded maximum subsidence, a forest burial rather than a marsh burial. This seems like a great idea except that the 1960 Chilean earthquake, the largest of the twentieth century, was preceded by great earthquakes in 1835 and 1837, less than one hundred and thirty years earlier. Also, it is not clear that less vertical subsidence means a smaller earthquake. The presence of the same number of turbidites in channels below submarine canyons from Washington to southern Oregon suggests that all these events are very large, close to magnitude 9.

## 10. Subduction-Zone Earthquakes That

# Don't Quake

Herb Dragert of the Pacific Geoscience Centre in Sidney, B.C., was checking the GPS records of tectonic strain accumulation in southern Vancouver Island when he caught what appeared to be an error in one of the measurements. Since 1992, the Pacific Geoscience Centre and the Pacific Northwest Geodetic Array (PANGA) GPS networks had been recording the slow accumulation of elastic strain in the North America Plate as the oceanic Juan de Fuca Plate drives northeastward beneath it. GPS stations in southern Vancouver Island and northwestern Washington had been showing a northeast-directed shortening of the geodetic base lines between them and a station at Penticton, B.C., in stable North America to the east. In his previous

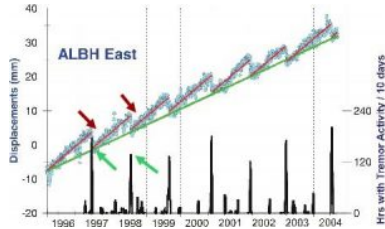

Fig. 4-24. Displacements plotted against time of a GPS station at Albert Head (ALBH), Victoria, B.C., relative to a station at Penticton, B.C., in stable North America. The diagram shows shortening from 1997 through 2004, except for brief periods where the displacement shows lengthening, or extension, of this survey line during episodic tremor and slip. During times of lengthening, seismographs record episodes of seismic tremor, possibly due to movement of fluid on or near the subduction zone. From UNAVCO and Ben Webber based on work by Herb Dragert and Garry Rogers, Pacific Geoscience Centre, Sidney, B.C.



checks, the stations were doing just that, but this time, the base line was going in the opposite direction, southwest rather than northeast, extending rather than contracting. Dragert determined that all the stations in southern Vancouver Island and northwest Washington were doing the same thing, lengthening their base lines. After he recognized that he was witnessing something real, the extension stopped, and the base line to Penticton began contracting again. Dragert had observed a *slow earthquake* in early 1997, defined as an earthquake that doesn't quake, in this case, a movement on the subduction zone not accompanied by strong shaking (Figure 4-24).

Meghan Miller, Tim Melbourne, and their colleagues at Central Washington University at Ellensburg began looking at the entire data set starting when the PANGA network first became operational in 1992. The network recorded a slow earthquake in mid-1992 and has been recording them ever since at intervals of about fourteen and a half months. If the strain had been released suddenly in an ordinary earthquake, it would have had a moment magnitude of 6.7, about the size of the devastating Northridge, California, earthquake of 1994. But because the strain was released slowly over a period of two to four weeks, nobody felt a thing. Michael Brudzinski of Miami University, Ohio, determined that the duration of these non-shaking earthquakes varies from place to place. In western Oregon, the duration is 19 months, and in southernmost Oregon and northern California, it is about ten months.

The area with the longest time between tremor events overlies the thick slab of crustal basalt known as Siletzia.

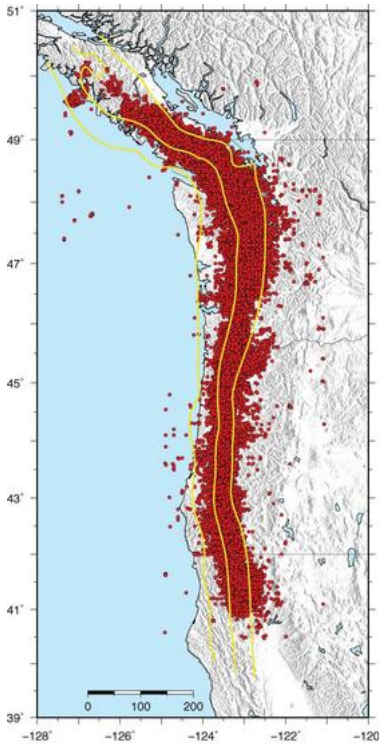

Fig. 4-25. Epicenters of episodic tremor and slip from 2006 to 2009 in Cascadia, from Aaron Wech, University of Washington, and the IRIS (Incorporated Research Institutions for Seismology) Image Gallery. Yellow contours are at 20, 30, and 40 km depth on the subduction zone. West of these epicenters, the Cascadia subduction zone is locked.

At first, it was thought that the seismograph network didn't detect anything, either. But Garry Rogers of the Pacific Geoscience Centre, working with Dragert, found that the slow earthquakes are accompanied by a strange seismic signal of lower frequency than ordinary earthquakes (Figure 4-18). These signals resemble volcanic tremor rather than slip on a fault, and Rogers suspects that they are related to fluids moving in the deeper part of the subduction zone. He was able to locate these seismic events on the subduction zone at depths of fifteen to twenty-eight miles. They are found in the same

places that the GPS stations recorded the slow earthquakes, although the seismic signal may extend farther northwest into Vancouver Island, beyond the reach of detailed GPS coverage. They are now known as *episodic tremor and slip (ETS)*, and they have been identified in other subduction zones around the world, including southwest Japan and southern Mexico. The comparison of seismic tremor with ordinary earthquakes is like comparing your stomach growling with breaking a stick or setting off a firecracker.

There have been enough of these ETS events to locate their “epicenters” on a map, shown here as Figure 4-25. The western boundary of the ETS events is relatively sharp, and this is now thought to correspond to the eastern boundary of the locked zone, independent of any estimates based on a downward projection of temperature. The eastern boundary of the locked zone is just east of the coastline in Oregon and includes a slightly wider part of the Washington coast.

Figure 4-26 is a cross section of the Cascadia subduction zone subdivided according to its expected response to deformation. It is useful to compare this figure with Figure 2-1, showing the increasing strength of rock with increasing depth. The westernmost subdivision is closest to the “trench” and is weak, moving by sliding unaccompanied by earthquakes. The next region has the highest strength. It has no earthquakes on it at all at the present time, and is expected to release its strain in gigantic subduction-zone earthquakes. The next zone to the east is

characterized by ETS, with slow earthquakes probably influenced by high fluid pressures. Still farther east is the zone of stable sliding, beneath the brittle-ductile transition, which extends eastward beneath the volcanic arc.

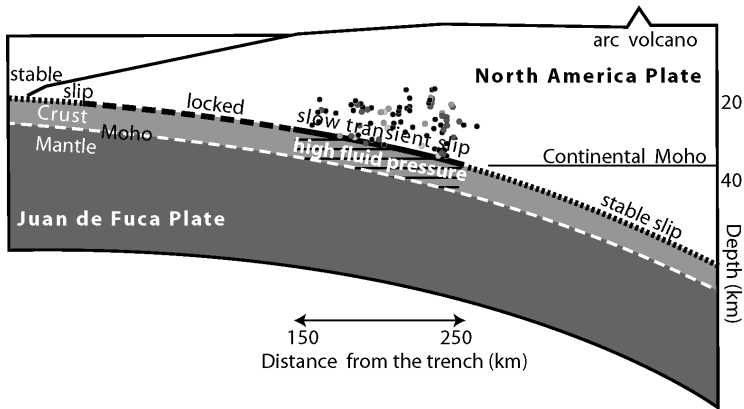

Fig. 4-26. Cross section through Cascadia subduction zone showing subdivision into a zone of stable sliding closest to the trench, the locked zone subject to great earthquakes, the zone of episodic tremor and slip, possibly related to high fluid pressure (epicenters in Fig. 4-25), and deep zone of stable sliding extending beneath the volcanic arc. From Gomberg et al. (2010).

Does this release of strain on the subduction zone reduce the threat of another M 9 subduction-zone earthquake? Dragert thinks that the opposite may be true: the release of strain in the transitional zone between brittle failure and ductile failure may increase the elastic strain on the shallower part of the subduction zone that is completely locked. It is possible

that the next major subduction-zone earthquake might be preceded by a slow earthquake, The 1960 Chile earthquake, the greatest of the twentieth century, was preceded by a slow earthquake. For this reason, the time of an ETS event is a time of greater concern that one of these events might trigger the next great subduction-zone earthquake. Everybody gets nervous. At present, it is the only possible “precursor” we have, and it might not be a precursor at all.

## II. Summary

Despite its low seismicity, the Cascadia Subduction Zone has been revealed as a major seismic source, capable of an earthquake of magnitude 9. The last earthquake was a 9, based on modeling of a tsunami that struck Japan in January 1700. The Native Americans who were living here in A.D. 1700 reported the earthquake in their oral traditions handed down from generation to generation. Some of the earlier earthquakes may have been smaller since the subsidence accompanying them was less than the subsidence in 1700. However, the consistent number of earthquake-generated turbidites identified in submarine channels on the Juan de Fuca Plate from Washington to southern Oregon argue for a magnitude 9 for most of these earlier events. The theoretical models of Roy Hyndman and Kelin Wang also point to a

magnitude 9. Goldfinger has shown that at least two of the earlier earthquakes had magnitudes larger than the 1700 earthquake.

In Del Norte and Humboldt counties in northern California, the situation is different. This region not only has the highest seismicity in the Pacific Northwest, it also has the highest seismicity in California, higher than that along the San Andreas Fault. The Cascadia Subduction Zone in this region was struck by a moderate-size earthquake in 1992 that, because it was closer to the trench, it uplifted the coastline rather than downdropped it as happened farther north. In addition, the earthquakes return more frequently in that area, as documented by uplifted coastal marine platforms and the more-frequent appearance of turbidites in submarine channels.

The paleoseismological record from Cascadia is the most fully documented in the world, yet the record does not allow us to forecast closely the arrival time of the next subduction-zone earthquake, nor does it allow a forecast of whether the next earthquake will be a 9 or larger or smaller. The recognition of episodic tremor and slip demonstrates that the subduction zone is active, but its current activity consists of slow slip events accompanied by earthquake tremor. This allows for the recognition of the landward boundary of that part of the subduction zone, and also suggests that the next great earthquake might be preceded by a slow slip event, or ETS.

However, we still have much to learn.

---

## *Suggestions for Further Reading*

- Atwater, B. F., and E. Hemphill-Haley. 1997. Recurrence intervals for great earthquakes of the past 3500 yr at northeastern Willapa Bay, Washington. USGS Professional Paper 1576, 108 p.
- Clague, J. J. 1997. Evidence for large earthquakes at the Cascadia Subduction Zone. *Reviews of Geophysics*, v. 35, p. 439-60.
- Clague, J., B. Atwater, K. Wang, M. Wang, and I. Wong. 2000. Great Cascadia earthquake tricentennial. Proceedings of the Geological Society of America Penrose Conference, printed by the Oregon Department of Geology and Mineral Industries, 131 p.
- Clarke, S. H., and G. A. Carver. 1992. Late Holocene tectonics and paleoseismicity, southern Cascadia subduction zone. *Science*, v. 255, p. 188-92.
- Dengler, L., G. Carver, and R. McPherson. 1992. Sources of North Coast seismicity. *California Geology*, v. 45, p. 40-53.
- Dengler, L., and K. Moley. 1999. Living on shaky ground: how to survive earthquakes & tsunamis on the North Coast. Humboldt Earthquake Education Center, Humboldt State University, 3rd edition, 24 p. (A simple guide to protection against earthquakes and tsunamis). Free. Web site:

[http://sorrel.humboldt.edu/~geodept/earthquakes/eqk\\_info.html](http://sorrel.humboldt.edu/~geodept/earthquakes/eqk_info.html)

- Goldfinger, C., C. H. Nelson, and J. E. Johnson. 2003. Holocene earthquake records from the Cascadia Subduction Zone and northern San Andreas Fault based on precise dating of offshore turbidites. *Annual Reviews of Earth and Planetary Sciences*, v. 31, p. 555-77.
- Goldfinger, C., Nelson, C.H., Johnson, J.E., et al., 2012, Turbidite event history: Methods and implications for Holocene paleoseismology of the Cascadia subduction zone: U.S. Geol. Survey Prof. Paper 1661F, <http://pubs.usgs.gov/pp/pp1661f/>
- Goldfinger, C., Ikeda, Y., and Yeats, R.S., 2013, Superquakes, supercycles, and global earthquake clustering: *Earth*, v. 58, no. 1, p. 34-43.
- Gomberg, J., and the Cascadia 2007 and Beyond Working Group, 2010, Slow-slip phenomena in Cascadia from 2007 and beyond: A review: *Geological Society of America Bulletin*, v. 122, p. 963-978.
- Gore, R., and J. Richardson. 1998. Cascadia: Living on Fire. *National Geographic*, v. 193, no. 5, p. 6-37
- Henderson, B., 2014, *The next tsunami: living on a restless coast*: OSU Press, Corvallis, 322 p.
- Houtman, N., Ashford, S., Mason, B., Barbosa, A., Bethel, J., and Olsen, M., 2013, *Terra, Oregon 9.0*, available at <http://oregonstate.edu/terra/2013/05/oregon-9-0/>.
- Hyndman, R. D. 1995. Great earthquakes of the Pacific



- Northwest. *Scientific American*, v. 273, no. 6, p. 50-57.  
Written for the lay reader.
- Kelsey, H. M., R. C. Witter, and E. Hemphill-Haley. 2002. Plate-boundary earthquakes and tsunamis of the past 5500 yr, Sixes River estuary, southern Oregon. *Geological Society of America Bulletin*, v. 114, p. 298-314.
- Lienau, M., for Global Net Industries. 2003. Cascadia: the Hidden Fire. One hour educational documentary video, [www.globalnetproductions.com](http://www.globalnetproductions.com)
- McCrary, P. A. 1996. Evaluation of fault hazards, northern coastal California. USGS Open-File Report 96-656, 87 p.
- Miller, M. M., T. Melbourne, D. J. Johnson, and W. Q. Sumner. 2002. Periodic slow earthquakes from the Cascadia Subduction Zone. *Science*, v. 295, p. 2423.
- Mitchell, C. E., P. Vincent, R. J. Weldon, and M. A. Richards. 1994. Present-day vertical deformation of the Cascadia margin, Pacific Northwest, United States. *Journal of Geophysical Research*, v. 99, p. 12, 257-12, 277.
- Oppenheimer, D., and others. 1993. The Cape Mendocino, California, earthquakes of April 1992: subduction at the triple junction. *Science*, v261, p. 433-38.
- Rogers, G., and H. Dragert., 2003. Episodic tremor and slip on the Cascadia Subduction Zone: the chatter of silent slip. *Science*, v. 300, p. 1942-43.
- Satake, K., K. Shimazaki, Y. Tsuji, and K. Ueda. 1996. Time and size of a great earthquake in Cascadia

- inferred from Japanese tsunami records of January, 1700. *Nature*, v. 379, p. 246-49.
- Schulz, K., 2015, The really big one: *New Yorker*, July 20, 2015, p. 52-59.
- Wang, K., R. Wells, S. Mazzotti, R. D. Hyndman., and T. Sagiya. 2003. A revised dislocation model of interseismic deformation of the Cascadia subduction zone. *Journal of Geophysical Research* v. 261, p. 433-38.

# 5. Earthquakes in the Juan de Fuca Plate

**Tower:** Horizon 177, [this is] Seattle Tower, you're No. 2 following a heavy Boeing 767, short final. Wind 130 at 8. Runway 16 Right. Cleared to land. (Pause). All right, we've got an earthquake. Everybody hold on, folks. (Pause). Attention all aircraft in Seattle. We have a huge earthquake going on. The tower is collapsing. I say again. The tower is falling apart. Hang on everybody. (Pause) OK, we got a huge earthquake going on in Seattle. Everybody be careful out there, all right?

**Pilot:** American 27 heavy, we're about to turn  
final.

**Tower:** All right, everybody on Seattle Tower, I want you to use extreme caution. The tower windows have collapsed here. Asiana 272 heavy, turn left here, hold short on 16 Left, remain on this frequency. And Horizon 301, I want you to turn left, and I want you to go to the ramp, and remain on this frequency. All the windows are gone from the tower but two.

**Pilot:** This is 301, we're turning off here at—

**Tower:** All right, I want everyone to pay

*attention here, because I don't know what's working and what's not. All the windows are gone.*

Sea-Tac tower operator Brian Schimpf  
during the 2001 Nisqually Earthquake

## I. Commotion in the Ocean

The Juan de Fuca Plate is entirely oceanic (Figures 2-7), with thin crust made up of basalt. No part of it is above sea level. The crust is nowhere more than a few tens of millions of years old, which means that it is relatively shallow, weak, and hot. Its weakness means that it is subject to internal deformation where it interacts with the continental edge of North America. At its northern and southern ends, where the spreading center is closest to the base of the continent, and the oceanic crust is youngest, the weak oceanic plate is being actively deformed internally, deformation that is marked by frequent earthquakes (Figure 4-14). These seismically active regions are generally referred to as separate plates, the Explorer Plate off Vancouver Island and the Gorda Plate off northern California (Figure 5-1). The Juan de Fuca Plate between its northern and southern ends has few earthquakes, indicating that internal deformation is less important there.

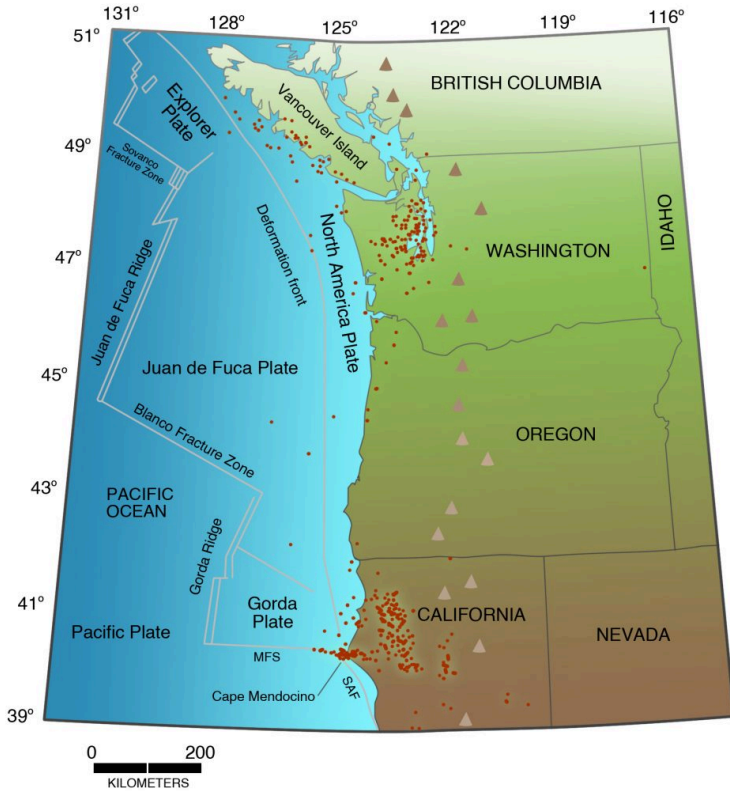

Figure 5-1. Distribution of earthquakes deeper than 16 miles in the Pacific Northwest. Most are intraplate earthquakes in the downgoing Juan de Fuca Plate. Earthquakes are not distributed evenly but are concentrated in Puget Sound, coastal Vancouver Island, and northwestern California. MFS, Mendocino Fracture System; SAF, San Andreas Fault; Heavy curved line in western Washington locates the top of the subduction zone at 60 km depth. Triangles: Cascade volcanoes. (100 km = 62 miles). From USGS Professional Paper 1560.

The fact that the Juan de Fuca Plate is completely

oceanic means that we are not able to measure its displacement rates directly but instead must rely on indirect geophysical evidence. All permanent seismic stations are onshore, resulting in considerable inaccuracy in locating earthquakes on the plate. However, in recent years, the declassification of the U.S. Navy's hydrophone detection system has allowed scientists of the National Oceanic and Atmospheric Administration (NOAA) in Newport, Oregon, to study earthquakes using seismic waves (*T-phase waves*) that are transmitted through ocean water rather than through the crust beneath the ocean. They have been able to improve greatly the accuracy and detection threshold for earthquakes far from shore (Figure 4-14).

Mapping of the distribution of earthquakes shows that the spreading centers, the Juan de Fuca, Gorda, and Explorer ridges, generate low-level seismicity related to the movement of magma that rises to the surface and forms new oceanic crust. These earthquakes are small, most of them too small to be detected by ordinary seismographs onshore, although they are monitored through the SOSUS hydrophone detection system.

On the other hand, the Gorda Plate is cut by large strike-slip faults that rupture frequently to cause earthquakes (Figures 2-4, 5-2). The Gorda Plate west of Arcata, California, sustained an earthquake of M 7.3-7.6 on January 31, 1922, that was felt in Oregon and Nevada, and as far south as San Jose, California. Another earthquake of M 6.9-7.4 thirty miles west of Trinidad,

California, on November 8, 1980, destroyed a bridge, liquefied the sand bar at Big Lagoon, and caused six injuries and \$1.75 million in damage. In 1991, the Gorda Plate was shaken by an earthquake of M 6.9 on July 12, another of M 6.3 on August 16, and the largest one of M 7.1 on August 17, three hours after a crustal earthquake onshore. On April 26, 1992, one day after the M 7.1 Cape Mendocino Earthquake on the Cascadia Subduction Zone, two aftershocks of M 6.0 and M 6.5 struck the Gorda Plate twelve and eight miles, respectively, offshore. One of these aftershocks trashed the commercial district of the small town of Scotia. These were the largest of hundreds of aftershocks of the Cape Mendocino earthquake in the Gorda Plate, complicating the problem of whether that earthquake was mainly a subduction-zone earthquake or a Gorda Plate earthquake. Except for the 1980 earthquake and the two Petrolia aftershocks, these Gorda Plate earthquakes were far enough offshore that intensities on the coast did not exceed V or VI.

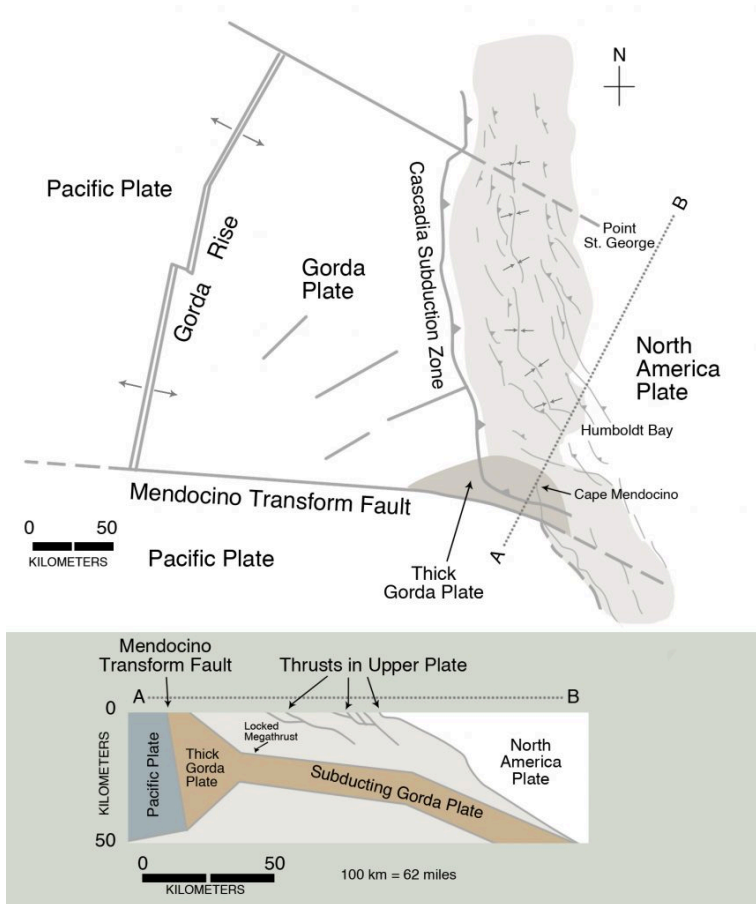

Figure 5-2. The Cascadia Subduction Zone approaches the coastline in northern California, where active folds and thrust faults have been studied by Gary Carver and his associates at Humboldt State University. The subduction zone ends at the Mendocino Transform Fault, which turns southeast to become the San Andreas Fault. The Gorda Plate and spreading center (Gorda Rise) are also shown. The plate is being internally deformed along the Cascadia Subduction Zone and Mendocino Transform Fault.



The Gorda Plate has accounted for more damaging historical earthquakes in northern California than any other source, including the Cascadia Subduction Zone and the North American Plate. However, it is incapable of producing earthquakes in the M 8 to 9 range, such as those expected on the Cascadia Subduction Zone.

The Explorer Plate off Vancouver Island is also shaken by frequent earthquakes (see Appendix A). But, unlike Gorda Plate earthquakes, these are far enough from populated areas that they do no damage and in some cases are not even felt onshore.

## 2. Offshore Transform Faults: The Northwest's Answer to the San Andreas Fault

In Chapter 2, we considered two types of plate boundaries: *ocean ridges* or *spreading centers*, where new oceanic lithosphere is created as plates move away from each other, and *subduction zones*, where oceanic lithosphere is recycled back into the interior of the Earth as plates move toward each other. The Juan de Fuca and Gorda ridges are examples of spreading centers, and the Cascadia Subduction Zone is an example of two plates converging (Figures 2-6 and 5-1). We also considered a third type of plate boundary where plates neither converge nor diverge but instead

move past each other without destroying or creating lithosphere. These are called *transform faults* because they transform plate motion between two spreading centers. They involve the entire lithosphere and not just the Earth's upper crust.

The San Andreas Fault is a transform fault in which continental rocks of the North America Plate move past continental rocks of the Pacific Plate (Figure 2-8, top diagram, and animation, Figure 2-9). Transform faults in the Pacific Northwest, on the other hand, are found on the deep ocean floor, where they form linear topographic features called *fracture zones*. The Blanco Fracture Zone separates the Juan de Fuca and the Gorda ridges, and the Sovanco Fracture Zone separates the Juan de Fuca and the Pacific plates (Figure 5-1). The Mendocino Fracture Zone separates the Gorda and Pacific plates and is the northwest continuation of the San Andreas Fault. These are typical transform faults. The grinding of one plate past the other causes many earthquakes on these fracture zones. Barring the next subduction-zone earthquake, they and the interiors of the Gorda and Explorer plates have the highest instrumental seismicity in the Pacific Northwest, onshore or offshore. Large earthquakes on the Mendocino and Blanco fracture zones are felt frequently every year in northern California and southern Oregon.

At first glance, the Blanco Fracture Zone resembles a left-lateral strike-slip fault because of the apparent left offset of the Juan de Fuca and the Gorda ridges (Figure

5-1). But this apparent left offset would only be true if these ridges had once been a continuous unbroken ridge that was later separated along the Blanco Fracture Zone. This is not the case. Remember that the Juan de Fuca Plate is moving away from the Pacific Plate at these spreading centers. Imagine yourself standing on the Pacific Plate looking northward across the Blanco Fracture Zone at the Juan de Fuca Plate. The Juan de Fuca Plate moves from left to right along the Blanco Fracture Zone with respect to your position on the Pacific Plate. This means that the transform fault on the Blanco Fracture Zone is a *right-lateral*, not a *left-lateral*, fault.

As another thought experiment, imagine two jigsaw puzzle pieces that lock together by a tab that projects from one piece into the other. Now pull the pieces slowly apart. They are difficult to separate because the sides of the tab resist being pulled apart. In the same way, the Pacific and Juan de Fuca plates are being pulled apart, with molten rock welling up along the spreading centers as the plates are separated. Along the Blanco Transform Fault, the crustal plates push past each other, generating friction and producing earthquakes. These earthquakes could be as large as magnitude 7 or even larger, but probably not 8. The crust is too warm and therefore too weak to generate such large earthquakes. Accordingly, despite the high instrumental seismicity on the Blanco Transform Fault, including many earthquakes felt onshore, it does not constitute a major hazard to communities along the

coast, in part because the earthquakes are many miles offshore, and in part because these offshore earthquakes are not large enough.

Earthquakes on the Mendocino Transform Fault are frequent. The first recorded major earthquake was felt on May 9, 1878, causing chimneys to fall in Petrolia, California, at the Triple Junction (Appendix A). A larger earthquake, of M 6.5-7.3, struck close to Cape Mendocino on January 22, 1923, resulting in intensities of VIII and damage to buildings in Petrolia. Other earthquakes include a magnitude 6 in 1922 and smaller earthquakes in 1932, 1936, and 1951. Other earthquakes with magnitudes greater than 6 struck in 1954, 1960, and 1984. The 1984 earthquake of M 6.6, 166 miles west of the coast, was felt from Oregon to San Francisco, but it produced intensities of V or less because of its great distance from shore. On September 1, 1994, an earthquake of M 6.9-7.2 struck the Mendocino Transform Fault 88 miles offshore, the largest earthquake to strike the United States that year, larger even than the Northridge Earthquake of the preceding January. Because it was so far offshore, it did no damage, but it was felt from southern Oregon to Marin County, California.

Like the Blanco and Mendocino faults, the San Andreas Fault is also a transform fault, separating the Gorda Rise from a spreading center in the Gulf of California of northwest Mexico (Figure 2-8, top diagram; Fig. 2-9 animation). The offshore transform faults differ from the San Andreas in involving relatively

hot oceanic crust and mantle, whereas the San Andreas cuts across colder continental crust for most of its length. For this reason, the San Andreas generates significantly larger earthquakes than does the Blanco, up to at least M 7.9. So, fortunately for the Pacific Northwest, the Blanco and Mendocino are the weaker relatives; they generate many earthquakes, but no giant ones.

Two transform faults lie off the coast of Vancouver Island: the Sovanco Fracture Zone that separates the Explorer Plate and the Pacific Plate, and the Nootka Fracture Zone that separates the Explorer Plate and the Juan de Fuca Plate (Figures 2-8, 5-1). Like the Blanco, these fracture zones are characterized by high seismicity, but are not believed to generate very large earthquakes. In the next chapter, we will consider the possible relation between the oceanic Nootka Fracture Zone and two large historical earthquakes in continental crust of central Vancouver Island.

Northwest of the Explorer Plate, the Pacific Plate grinds against the North America Plate along the Queen Charlotte Fault, located at the base of the continental slope. On August 22, 1948, this fault was the source of an earthquake of M 8.1, larger than any historical earthquake on the west coast of the United States south of Alaska. On October 27, 2012, this fault was the source of the Haida Gwaii earthquake of M 7.8 (using the First Nations name, Haida Gwaii, for the Queen Charlotte Islands). This fault had a focal mechanism of reverse faulting rather than the expected strike slip. These

earthquakes are evidence that the Queen Charlotte Fault poses a hazard to the thinly populated coast of British Columbia north of Vancouver Island, including the Queen Charlotte Islands. However, the region is so thinly populated that it is not considered as a major earthquake threat in Canada.

### 3. Slab Earthquakes in the Juan de Fuca Plate Beneath the Continent: Puget Sound Region

The greatest amount of seismicity generated by the Juan de Fuca Plate itself (not including the Explorer and the Gorda plates) is beneath western Washington, where it is being subducted beneath North America (Figures 3-21, 5-1). These are called *slab earthquakes* or *Benioff zone earthquakes*. Most of the damage and loss of life in the Pacific Northwest has been as a result of these earthquakes, including the largest known historical shocks to strike either Washington or Oregon.

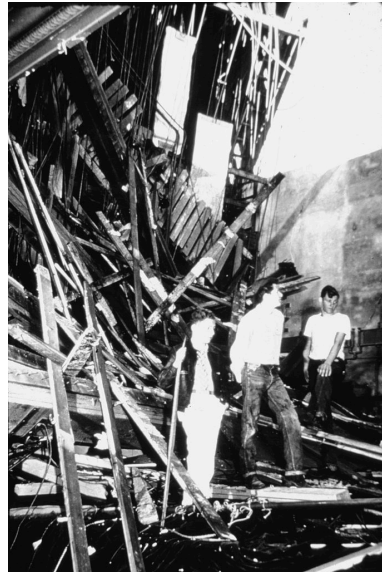

*Figure 5-3. Puyallup High School damaged in 1949 earthquake. Unanchored roof and ceiling beams over the stage of the auditorium slid off supporting walls and crashed to the floor. From Thorsen (1986); illustration from collection of Washington Division of Geology and Earth Resources*

The first of these, on April 13, 1949, really should have been no great surprise. The southwesternmost Puget

Sound region had been struck by earthquakes on November 13, 1939 (M 5.5-5.9), and on February 15, 1946 (M 6.3). Both were slab earthquakes, and both had produced intensities as high as VII, which meant minor damage and collapse of chimneys. The 1949 earthquake of M 7.1 struck the southern Puget Sound region just before noon on April 13. Strong shaking lasted about thirty seconds. Most people were at work, getting ready to go to lunch. Most schools were on vacation, which turned out to be a blessing because of the collapse of many unreinforced brick school buildings. The epicenter was between Olympia and Fort Lewis, and the high-intensity damage zone extended from Rainier, Oregon, on the Columbia River, north to Seattle (Figures 5-3 to 5-5). The earthquake was felt from Vancouver, B.C., to Klamath Falls and Roseburg, Oregon. A sidewalk clock outside a jewelry store at 1323 Third Avenue in Seattle stopped at the moment of the earthquake: 11:56.





*Figure 5-4. Damage to Old State Building, Olympia, Washington, in 1949 earthquake. From Thorsen (1986); illustration from collection of Washington Division of Geology and Earth Resources*

Eleven-year-old Marvin Klegman was killed, and two other children were injured by falling bricks as they played outside the Lowell School in Tacoma. Jack Roller was killed when part of the Castle Rock School building collapsed on him. Five students and two teachers were injured at Adna School 10 miles west of Centralia. One little girl was critically injured as she left her second-grade classroom. Tons of bricks fell from the Lafayette School building in Seattle, but school was

not in session, and children were playing in the schoolyard far from the building. The Lafayette School was one of ten Washington schools condemned after the earthquake. The auditorium collapsed at Puyallup High School (Figure 5-3), but no one was in it at the time. Part of the Boys Training School at Chehalis crumpled and fell, injuring two boys.

There were many narrow escapes. Freda Leaf, seventy-one, jumped into the Duwamish River but was

rescued by a neighbor, D. V. Heacock. Part of the roof of the Busy Bee Restaurant on Second Avenue in Seattle fell in, and the patrons headed for the exit. The proprietor, George Pappas, immediately saw the danger and ordered the bartender, a big man named Bill Given, to block the exit. Moments later, tons of bricks cascaded onto the sidewalk in front of the restaurant. Water spilled out of an old water tower at the reservoir at Roosevelt Way and East 86th Street; a few minutes before, painters working at the tower had knocked off for lunch. At the Tacoma Narrows Bridge, under repair at the time, a twenty-three-ton steel saddle mounted to hold up a suspension cable dislodged and plunged off the bridge and through a scow on the water below, injuring two people. In Olympia, the Old State Building (Figure 5-4) and the State Insurance Building were the worst hit. Governor Arthur Langlie and his assistant, Dick Everest, were in their offices in Olympia and were showered with falling plaster.



*Figure 5-5. Yesler Way, downtown Seattle, showing damage in 1949 earthquake from falling parapets and brick ornamentation and a collapsed fire escape, shown at left. Photo by George Cankonen, Seattle Times*

At the Blue Mouse Theater in Tacoma, people were watching the earthquake scene from *The Last Days of Pompeii* as the earthquake struck. In a bizarre coincidence, a crucifixion scene with accompanying earthquakes was being shown at the time of the earthquake at the nearby Roxy Theater. At Second and Occidental in Seattle, a man was seen walking rapidly down the street after the earthquake clad only in underwear, sports coat, and shoes.

In Oregon, broken water pipes flooded the basements of two stores in Astoria, plaster cracked in Florence, and dishes crashed from their shelves in

Newport. Chimneys crashed at Reed College in Portland, and office workers on the twelfth floor of the new Equitable Building were knocked to the floor.

Fortunately, perhaps amazingly, only seven lives were lost, and damage was only \$15 million, even though the magnitude was 7.1. In today's dollars, the losses would be perhaps twenty times that; the losses to Washington schools alone would have been \$60 million in 1998 dollars. But losses were still remarkably low. Probably the main reason, aside from school being out of session, was that the focal depth of the earthquake was about thirty-five miles below the surface, meaning that the shock waves had thirty-five miles to weaken in amplitude before reaching the surface. Because it was such a deep earthquake, the Intensity VIII zone was very large, but there were no areas of Intensity IX or X, as there would have been with a shallower crustal earthquake of the same magnitude.

On April 29, 1965, at 8:29 in the morning, a second large slab earthquake with magnitude 6.5 struck between Kent and Des Moines, south of Sea-Tac Airport between Seattle and Tacoma. Like the 1949 earthquake, its focus was more than thirty miles beneath the surface.

Adolphus Lewis, seventy-five, a retired laborer, was on his way from his hotel room to have breakfast when he was killed by falling debris (Figure 5-6). Raymond Haughton, fifty-two, was killed, and Eugene Gould, fifty, critically injured when a fifty-thousand-gallon wooden water tank on a two-hundred-foot tower collapsed at

the Fisher Flouring Mills. In total, six people were killed, including those suffering heart attacks, and property damage was estimated as \$12,500,000, \$60 million in 1998 dollars.



*Figure 5-6. Falling bricks from this building on King Street, Seattle, during 1965 earthquake caused one death. From Karl V. Steinbrugge Collection, Photo 2876*

As in 1949, there was considerable damage to school buildings. In Seattle, parts of Broadview Elementary School collapsed, and there was damage to the Ballard High School auditorium. The greatest damage was to West Alki Elementary School, where a chimney sixty feet high fell into the boiler room, narrowly missing the custodian. Unlike 1949, no pupils were injured.

The 8:15 mass at St. James Cathedral was interrupted when low-hanging chandeliers began to swing

violently. Two hundred parishioners fled the cathedral, but returned for the remainder of the service when the tremors subsided. At the Rainier Brewing Company, two thousand-barrel aging tanks were knocked off their platforms. One split open, spilling enough beer for fifteen thousand cases. Engineer John Strey found himself wading hip deep through the foamy beer. The restaurant at the top of the Space Needle was full of customers when it began to sway, “like riding the top of a flagpole.” No one ran for the elevators, and all finished breakfast after the violent shaking had ceased.

The next earthquake arrived thirty-four years later at 6:44 p.m. July 2, 1999, at Satsop, Washington, ironically the site of a nuclear power plant proposed by the Washington Public Power Supply System that, fortunately, never got built. The earthquake had a moment magnitude of 5.8 and was twenty-five miles deep. The lovely old Grays Harbor County Courthouse in Montesano, built in 1910, was severely damaged. The ceiling and an exterior wall of Moore’s Furniture Store in Aberdeen collapsed, causing extensive havoc inside. Chimneys toppled, gas lines leaked, and power went out throughout much of Grays Harbor County. John Hughes of *The Daily World* in Aberdeen reported from the parking lot on State Street that “(s)treelight poles shook, my Volkswagen Beetle did the Macarena while Dee Anne Shaw’s Chrysler coupe was undulating.”

Then came 11:54 a.m. on Ash Wednesday, February 28, 2001.

I was having a late-morning cup of coffee in Corvallis

when I began to feel dizzy. The two people across the table from me continued to talk and obviously felt nothing, so I thought I was ill. Then I saw the swaying of a lamp and realized that I was feeling the long-period waves from a distant earthquake.

Brian Wood of KIRO-TV was setting up for a press conference by Seattle Mayor Paul Schell, who was about to explain the city's response to the Mardi Gras riots the previous night in which one person had been killed. Before the mayor arrived, the room began to shake, and Wood immediately began to broadcast: "This is Brian Wood, live in downtown Seattle, live on the twelfth floor of the mayor's conference room. We were waiting for a news conference when it hit, an earthquake." This made KIRO first with the story, which was broadcast nationwide. Later, ABC in New York would ask sheepishly if it could carry the story from KIRO, a CBS affiliate, because its ABC affiliate, KOMO-TV, had taken too much time getting organized.

Curtis Johnny and his girlfriend, Darlene Saxby, headed for the exit of their South Park apartment as soon as they felt the earthquake. Suddenly, a chimney crashed through the ceiling, covering Johnny with bricks. "I was pretty hysterical," Darlene said. "I was just throwing bricks off of him and screaming at the same time." Neighbors had to break in the door to the apartment to get them out. Hin Pang and his wife Sim Pang were visiting friends at a Chinatown club when the earthquake hit. As they ran from the building, they were struck by a shower of bricks from a ledge three

stories above them. Sim Pang suffered head, chest, and arm injuries but was released from Harborview Medical Center later in the day. She had been buried by the bricks, and she suffered chest injuries and a crushed pelvis; he remained in the hospital for a longer time but survived.

Old buildings fared the worst. Tops of brick buildings crashed to the street along Alaskan Way Viaduct and along Second Avenue, crushing cars. A huge piece of the Fenix Underground, a night club on Second Avenue South, fell on two parked cars; the inside wall collapsed, trapping club owner Mike Lagervall and his secretary inside. The roof of the Washington Federal Savings building partially fell in, and one of its façades covered a ninety-foot stretch of sidewalk (Figure 5-7). The Compass Center, a facility for eighty homeless men in Pioneer Square, had to be abandoned. The Alaskan Way Viaduct itself, built in 1953 for \$8 million, suffered damage but did not collapse; replacing it would cost \$400 million. (A few years later the Alaskan Way viaduct would in fact be replaced.) The great stone columns of the Capitol Dome in Olympia, built in 1928, were knocked out of line. State employees were allowed to return at the end of April, but tours of the Capitol were not scheduled to resume until the end of 2004. Chunks of concrete fell sixty feet from the top of support pillars in the Garfield High School gym. In Centralia, the rooftop brick façade of Coast to Coast Hardware collapsed and punched holes in a lower roof of the rear addition.





*Figure 5-7. Parapet failure on the south side of the Washington Federal Savings building in downtown Olympia as a result of the 2001 Nisqually Earthquake. Downtown Olympia is built on several hundred feet of latest Pleistocene sediments, which amplified seismic waves. Photo by Joe Dragovich, Washington Division of Geology and Earth Resources.*

In the Grand Ballroom of the Westin Hotel in downtown Seattle, Bill Gates was onstage about to demonstrate Microsoft's forthcoming Windows XP operating system when the shaking began. Talking stopped, and Gates looked around as ceiling tiles began to fall. Giant chandeliers swayed, and the audience started screaming and heading for the exits or crawling under chairs. Gates calmly walked offstage, perturbed at being interrupted, even as a piece of light fixture the size of a cereal box fell next to him. Asked later if he had been frightened, Gates said,

"No, I was worrying about what was going on, was there a bomb, or what was going on."

There were light moments. Joanne Smith, a third-grade teacher at St. Matthew Parish School in Hillsboro, Oregon, led her children out onto the damp playground where they watched dozens of earthworms come out

of the ground, disturbed by the surface waves of the earthquake. In Seattle, Skyler Dufour, nine, collected rubble to be offered on eBay with bids opening at seven dollars. At De Laurenti's Specialty Foods in the Pike Place Market, two hundred bottles of wine fell to the floor, with the fifty-five-dollar bottles on the top shelf falling the farthest. Steve Springston, a wine buyer, observed that "it was a very complex aroma." Christopher Carnrick was participating in a videoconference when the room started to shake. He jumped on the table, took a surfing stance, and shouted, "I am RIDING this BABEE out," not realizing that his surfing adventure was being viewed by astonished participants in San Francisco and Montana.

Governor Gary Locke estimated the damage to be as great as two billion dollars. But on the other hand, only one person died, a Burien woman who had a heart attack during the earthquake; 396 people were injured. But on reflection, it became obvious that the damage could have been much worse. First, it was a deep earthquake, so that seismic waves had a longer distance between the hypocenter and the surface for waves to diminish, or attenuate. A subduction-zone earthquake would have had strong shaking over a much longer time, and a crustal earthquake of the same magnitude would have had much more powerful seismic waves and greater intensities. Second, the Puget Sound region was in its second straight dry winter, and water tables were the lowest in thirty years, reducing the potential for liquefaction. Finally, Seattle had just completed a Project

Impact preparedness exercise; many structures had been retrofit, and people were much better informed than they had been. (Paula Seward, vice president of Northwest sales at Quakeproof, was in the middle of a presentation about earthquake preparedness to a group on the third floor of a downtown Seattle hotel when the quake struck. A participant asked her, “Is this part of your sales presentation?”)

In short, this was not the Big One. As Bill Steele of the Pacific Northwest Seismograph Network put it, “If you’re going to have a magnitude 7 in the Puget Sound area, let it be a deep one.”

## 4. Northern California

What about the onshore Gorda Plate in northern California? An earthquake of M 6.75 on November 23, 1873, on the thinly settled Oregon-California border may have been a slab earthquake. After this earthquake, cracks in the ground appeared on the trail between Crescent City and Gasquet in the Smith River Valley, and all the chimneys were knocked down. The highest intensity recorded was VIII, in a limited area in the northwestern corner of California, but intensities of V were felt over a broad area from Red Bluff in the south to McMinnville, Oregon, in the northern Willamette Valley. Newspaper accounts did not report any aftershocks.

## 5. Discussion and Summary

Why should seismicity within the subducting oceanic plate be concentrated in the Puget Sound region? Oddly, this lower-plate seismicity does not extend very far south into Oregon (Figure 5-1). If subduction is taking place all along Cascadia, why should seismicity be concentrated only in Washington?

To answer this question, we look at the contours of the subducting Juan de Fuca Plate, and we observe that the plate has an eastward-convex bend in Washington, curving from a north trend in Oregon to a northwest trend in southwest British Columbia (Figure 5-8). This bend is also reflected in the distribution of Cascade volcanoes (Figure 5-1). In northern California, Oregon, and southern Washington, these volcanoes line up north-south, parallel to the subduction-zone contours. But in southwest British Columbia and northern Washington, including Mt. Baker and Glacier Peak, the volcanoes line up northwest-southeast, parallel to the subduction-zone contours.



A video element has been excluded from this version of the text. You can watch it online here:

<https://open.oregonstate.education/earthquakes/?p=104>

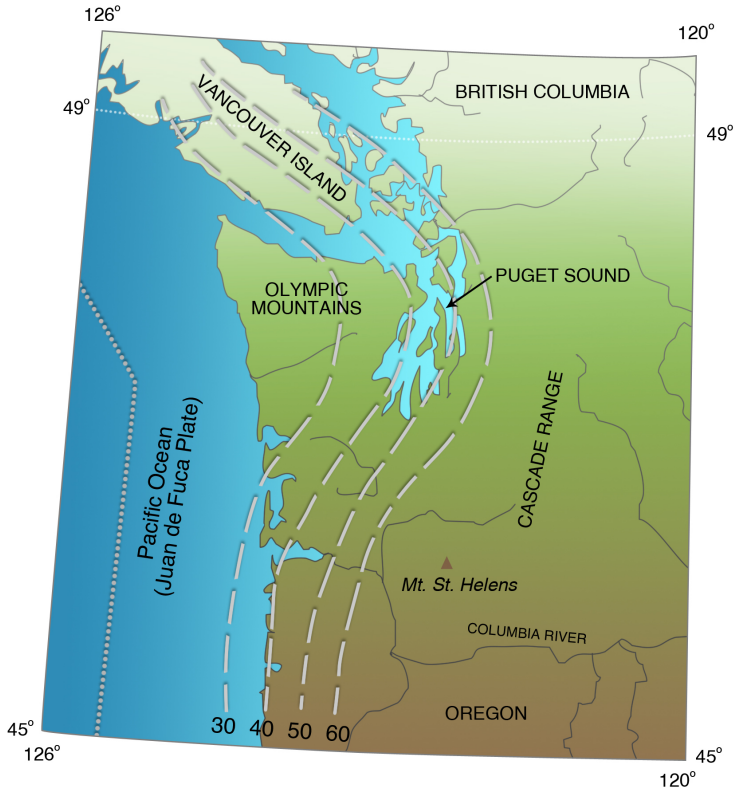

Figure 5-8. The distribution of slab earthquakes helps determine the contours of the top of the Juan de Fuca Plate, in kilometers below sea level. Notice that these contours are convex to the east, causing compression within the slab as it subducts beneath North America, analogous to the folds in a tablecloth at the corner of a table. From Robert Crosson, University of Washington

This arch in the subduction zone may explain why the Olympic Mountains are so much higher than the Coast Range of Oregon or the hills of southwest Washington.

The Olympic Mountains are arched up where the subduction zone bends the most, in map view.

To imagine the effect of this eastward-convex arch, consider a tablecloth hanging over the corner of a table. The tablecloth is straight along the sides of the table, but it makes a fold at the corner. Now suppose that, instead of a tablecloth, the table is covered by a sheet of hard plastic, the edges of which stick out over the side of the table. You want to bend the plastic down the side of the table, like the tablecloth, but you find that it won't bend at the corner unless you make a cut in the plastic so that the two sides fit together down the sides. (This is the same difficulty I have in gift-wrapping a present in a box. The wrapping folds neatly down the sides of the box, but in order to make the corners neat, I have to make a fold in the wrapping paper where it goes around the corner. I do not excel at this, and so I generally have the present gift-wrapped at the store or by my wife.)

The Juan de Fuca Plate has the same problem when it is forced to bend beneath North America. The plate can bend easily beneath Oregon or beneath southwest British Columbia, where the subduction zone is straight, but in trying to bend beneath the curved arch beneath Washington, internal stresses are built up that generate earthquakes.

This "corner problem" explains the distribution of slab earthquakes beneath Puget Sound, but not in southwest British Columbia. Slab earthquakes occur there in two zones, even though the downgoing Juan de Fuca Plate there is relatively straight. One zone is a

northward continuation of the Puget Sound deep zone, and it dies out near Vancouver (Figure 5-1). The other zone is beneath the west coast of Vancouver Island and it has lots of earthquakes (Figure 5-9). Leiph Preston and Ken Creager of the University of Washington have found earthquakes in this western zone as far south as southwestern Washington. These earthquakes tend to occur in the oceanic mantle of the Juan de Fuca Plate whereas earthquakes of the eastern zone are more likely in the oceanic Juan de Fuca crust (Figure 2-5).

Why should the slab have earthquakes beneath the straight subduction zone in British Columbia, but not the straight subduction zone in Oregon? Seismologists at the Pacific Geoscience Centre in Sidney, B.C., are quick to say that “we really don’t know.” The deeper zone of high seismicity may correspond to a downward increase in the dip of the subducting slab beneath Vancouver Island and the mainland coast, producing a bend in the slab (Figure 5-9). The zone beneath the west coast of Vancouver Island may correspond to a shallower bend, but seismologists disagree on this point.

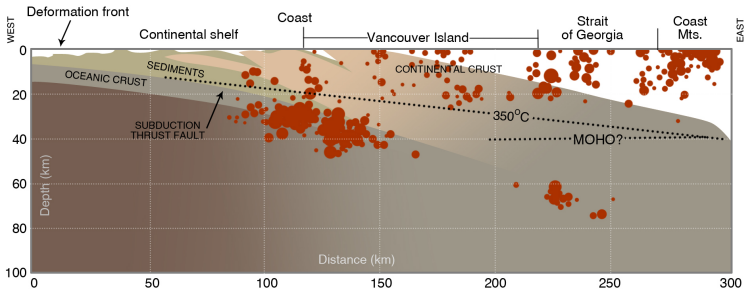

Figure 5-9. Cross section of the Cascadia Subduction Zone across southern Vancouver Island showing crustal structure based on surface geology, a deep seismic-reflection profile, the distribution of earthquakes located by seismographs (filled dots; size proportional to magnitude), and temperature based on geothermal measurements onshore and offshore. From Garry Rogers and Roy Hyndman, Pacific Geoscience Centre, Sidney, B.C.

We have assumed that Oregon has a hazard from slab earthquakes, just as Washington does, even though it has not had any big slab earthquakes in historical time, with the possible exception of the 1873 earthquake near the California border, considered further below. Perhaps the Puget Sound earthquakes are in a temporal cluster, an increase in slab earthquakes over nearly a century, and at some future time, Oregon might have a similar cluster. But not only does Oregon lack large slab earthquakes, it also has essentially no small ones either, whereas these are abundant in western Washington and in northern California (Figure 5-1). It is difficult to explain the lack of slab seismicity by saying that the slab is fully locked, because the earthquakes farther



north are broadly distributed and are not localized on a few faults within the slab. Ivan Wong of URS Greiner Associates (2005) suggests that the Oregon slab is younger than it is in Washington, and the convergence rate between the Juan de Fuca and North America plates may be slower than in Washington. In addition, the crust of western Oregon is underlain by Siletzia basalt, which, as stated above, keeps the temperature of underlying Juan de Fuca Plate too hot to generate slab earthquakes. Wong also reanalyzed the 1873 Brookings earthquake, previously believed to have occurred in the Juan de Fuca Plate, and concluded that this earthquake was crustal, like similar earthquakes in northern California. The implication of Wong's observations is that western Oregon faces hazards from the subduction zone and earthquakes in the crust, but unlike western Washington, does not face a hazard from the Juan de Fuca Plate. However, this idea is speculative, and not confirmed enough for Oregonians to relax and not worry about slab earthquakes like those in Washington.

Another mystery is that wherever the deep slab is seismically active, the overlying continental crust is active, too. The crustal seismicity is high beneath Puget Sound where the slab seismicity is high. In Northern California, both the Gorda Plate and the overlying and adjacent continental crust are characterized by frequent earthquakes. On Vancouver Island, the largest crustal earthquakes occurred on the onshore projection of the Nootka Transform Fault, and they

were characterized by left-lateral strike-slip faulting, just as earthquakes on the Nootka Fault are.

If our speculations about a bending origin for the localization of seismicity are correct, there should be no relationship between earthquakes in the slab and earthquakes in the crust. Yet they appear to be somehow tied together, even though the seismicity zones in North American crust and in the Juan de Fuca Plate are generally separated by lower crust that is too hot and ductile to produce earthquakes (Figure 5-9). These questions, now being addressed by seismologists in Canada and the United States, are of practical importance because they bear on estimates of hazards in the Pacific Northwest and the Vancouver-Victoria region.

In summary, the three largest slab earthquakes in the Puget Sound region were characterized by very large areas of intensity VII, but only the 1949 earthquake had a very large area of intensity VIII. There were no areas of higher intensity, such as one would expect for crustal earthquakes of the same magnitude, probably due to the greater distance from the source to the ground surface. Unlike crustal earthquakes, the Puget Sound slab earthquakes, including the 1939 and 1946 Puget Sound earthquakes, lacked significant aftershocks. A deep earthquake off the west coast of Vancouver Island on December 16, 1957, with M 5.9, had only one aftershock, and intensities recorded were not much higher than III. The Nisqually Earthquake had four aftershocks in the following two weeks.

Even though the slab earthquakes beneath western Washington have caused most of the damage and loss of life in the Pacific Northwest, the general conclusion is that the Juan de Fuca Plate beneath the edge of the North American continent is not capable of storing enough strain energy to produce earthquakes much larger than the M 7.1 event of April, 1949 beneath Puget Sound. But the downgoing plate, covered as it is by continental crust, is still not well enough known to make this statement with a lot of confidence.

---

### *Suggestions for Further Reading*

- Preston, L. A., K. C. Creager, R. S. Crosson, T. M. Brocher, and A. M. Tréhu. 2003. Intraslab earthquakes: Dehydration of the Cascadia slab. *Science*, v. 302, p. 1197-1200.
- Rogers, A.M., T. J. Walsh, W. J., Kockelman, and G. R. Priest, eds. 1996. Assessing earthquake hazards and reducing risk in the Pacific Northwest. U.S. Geological Survey Professional Paper 1560, 306 p.
- Staff of the Pacific Northwest Seismograph Network. 2001. Preliminary report on the MW = 6.8 Nisqually, Washington earthquake of 28 February 2001. *Seismological Research Letters*, v. 72, p. 352-61.
- Thorsen, G. W., compiler. 1986. The Puget Lowland earthquakes of 1949 and 1965. Washington Division of

- Geology and Earth Resources, Information Circular 81, 113 p.
- Washington Division of Geology and Earth Resources Staff. 1999. July 2, 1999, Satsop earthquake. Washington Geology, v. 27, no. 2/3/4, p. 28-29. Includes an account by John Hughes of The Daily World, Aberdeen.
- Washington Division of Geology and Earth Resources Staff. 2001. Nisqually earthquake issue. Washington Geology, v. 26, no. 3, p. 2-21.
- Wong, I.G., 2005, Low potential for large intraslab earthquakes in the central Cascadia Subduction Zone: Seismological Society of America Bulletin, v. 95, p.1880-1902.

# 6. Earthquakes in the Crust: Closer to Home

*“They laugh and play in the sleepy harbor town  
So unaware of the danger that’s around*

*Livin’ on the fault line*

*Livin’ on the fault line.*

*No one can run when it finally comes down*

*Nobody knows what is stirrin’ underground*

*Livin’ on the fault line*

*Livin’ on the fault line.*

Doobie Brothers

## 1. Introduction

We have heard the bad news regarding the next great subduction-zone earthquake, but there is one small bit of good news. Based on the edge of the ETS zone, west of which the subduction zone is currently locked, the epicenter is likely to be offshore or close to the coast: more than 50 miles from Portland, one hundred miles from Seattle, and a bit farther from Vancouver (Figure 4-25). This means that due to attenuation, seismic

waves will be smaller when they reach the major population centers than when they strike the coast.

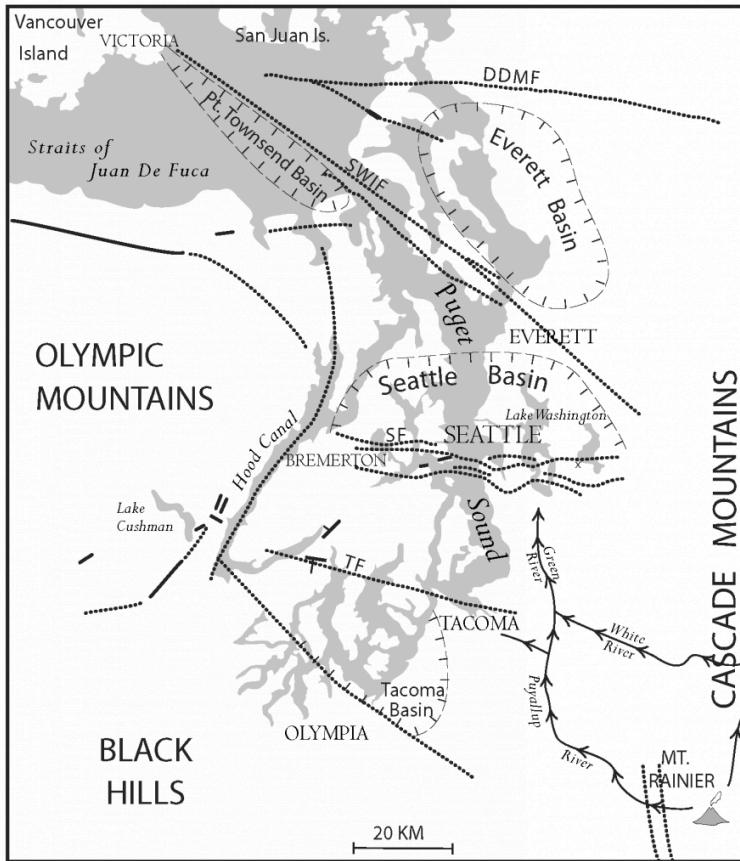
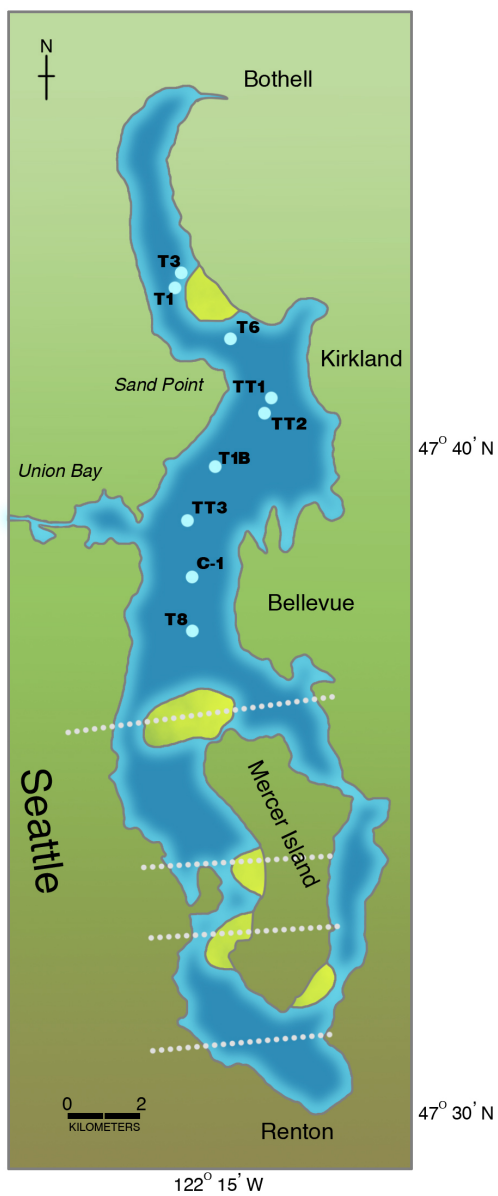

Figure 6-1. Quaternary faults of western Washington (heavy dashed lines). Faults with solid lines are major reverse faults, probably not active, with arrows toward the hanging-wall side. Seattle and Tacoma faults are generally east-trending and are close to the cities for which they are named. The fault striking northwest-southeast is the Southern Whidbey Island fault, extending from southeast of Victoria, B.C., southwest of Everett, and into the foothills of the Cascades. The Olympia fault also strikes northwest-southeast.



A video element has been excluded from this version of the text. You can watch it online here:

<https://open.oregonstate.education/earthquakes/?p=143>





*Figure 6-2. Map of Lake Washington, bordering the city of Seattle on the east, locating major landslides and sunken forests (coarse dot pattern). Dashed lines extending across southern half of lake are possible traces of the Seattle Fault. Solid circles are piston core sites that are correlated in Figure 6-5. Modified from Robert Karlin, University of Nevada Reno, and Sally Abella, University of Washington*

---

But there is still more bad news. The continental crust directly beneath Seattle, Tacoma, and Portland has its own earthquake problem. Figure 6-1 shows potentially active faults in the Puget Sound region. Earthquakes within the crust would be a lot smaller, to be sure. The largest historical crustal earthquake, of magnitude 7.3, struck a thinly populated area on central Vancouver Island in 1946. Three earthquakes in Oregon in 1993 served as wake-up calls: the Scotts Mills “Spring Break Quake” of M 5.6 near Salem, and two earthquakes west of Klamath Falls of M 5.9 and 6.0. The Scotts Mills Earthquake resulted in more than \$28 million in losses, including damage to the rotunda at the State Capitol in Salem.

Figure 6-2 shows the large earthquakes in the Pacific Northwest from 1833 through 2001, all of which ruptured either the continental crust, the oceanic crust of the Juan de Fuca Plate or Gorda Plate offshore, or

the oceanic crust of the Juan de Fuca Plate beneath the continent in western Washington.

Our historical earthquakes have been troublesome, particularly for the communities affected, but they have not been major disasters like the Northridge or Kobe earthquakes. But evidence has been found for other, more ominous, prehistoric earthquakes that, if they happened today, would result in catastrophic losses to the Puget Sound region. Our story begins in Seattle and an earthquake that took place eleven hundred years ago, shortly before the time of the Norman Conquest of Britain. The detectives uncovering evidence of this earthquake are paleoseismologists, practicing their new field of identifying earthquakes by their geologic signature. The fault they discovered extends east-west through downtown Seattle, beneath the most expensive real estate in the Pacific Northwest.

## **2. Drowned Forests, Raised Shorelines, and the Seattle Fault**

When the level of Lake Washington was lowered in 1916 to accommodate the Lake Washington Ship Canal, boaters noticed something strange beneath the surface of the lake. Dead trees! In growth position, underwater, like silent phantoms (Figure 6-2). In 1919, more than 175 of them, primarily Douglas fir, were removed as

navigational hazards. But there were still enough of them left that in 1991 salvage logging was attempted, using a barge and crane to raise the tree trunks from the floor of the lake (Figure 6-3). The wood was found to be in surprisingly good shape.



Figure 6-3. Tree trunk dredged from Lake Washington and dated as 1,100 years old. Photo courtesy of Pat Williams, Lawrence Berkeley Laboratory

Careful underwater surveying with side-scan sonar revealed a drowned forest northwest of Kirkland near the eastern shore of the lake, and two others off the southeast and southwest shores of Mercer Island. How did the forests get there? The surveys of the lake floor, together with observations by divers, showed that the forests slid into the lake as parts of giant landslides.

The rings on some of the tree trunks that were hauled up for logging extended all the way out to the bark (Figure 6-4), which enabled Gordon Jacoby of Columbia University (Fig. 4-15) to show that all the trees died in the fall, winter, or early spring of the same year, about a thousand to eleven hundred years ago. More landslides were found on the south side of Union Bay and at the north end of Mercer Island. But what triggered the landslides, and why did they happen all at once?

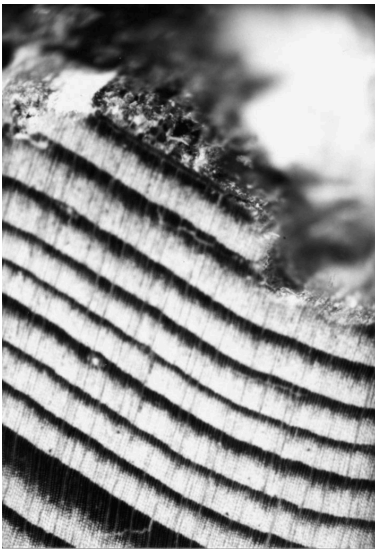

*Figure 6-4 Tree rings from a 1,100-year-old tree dredged from the bottom of Lake Washington. Dark zone at top is the bark. Each pair of light and dark rings represents annual growth of one year. Photo by Gordon Jacoby, Columbia University*

To answer this question, Bob Karlin of the University of Nevada-Reno and Sally Abella of the University of Washington took core samples of sediments that have been accumulating at the bottom of the lake for more than thirteen thousand years, following the melting of a great Pleistocene ice cap that covered Puget Sound as far south as Olympia. An ash layer in many of the cores came from the catastrophic volcanic eruption at Crater Lake

that was known to have taken place 7,700 years ago. The

sediment cores contain fossil pollen, providing information about changing conditions on land surrounding the lake as well as changing climate since the Ice Age (Figure 6-5). Starting in the 1880s, the pollen changes abruptly from Douglas fir to alder, evidence of systematic logging and the steady deforestation of western Washington starting about that time. This sediment also provides evidence for the lowering of the lake level when the Ship Canal opened in 1916.

Karlin and Abella found an unusually conspicuous sediment layer between the Crater Lake ash bed and the flood of alder pollen as logging of the evergreen forests began (Figure 6-5). This layer was deposited by a flow of turbid sediment, a miniature version of the sediment flows that were generated by Cascadia Subduction Zone earthquakes and transported down the great submarine canyons on the continental slope, as discussed in Chapter 4. By correlating the magnetic properties of sediments from core to core (Figure 6-5), Karlin and Abella determined that this sediment layer was deposited about eleven hundred years ago, about the same time that the landslides carried the forests to the bottom of Lake Washington. Could the sediment layer and the landslides have the same origin?



A video element has been excluded from this version of the text. You can watch it online here:

<https://open.oregonstate.education/earthquakes/?p=143>

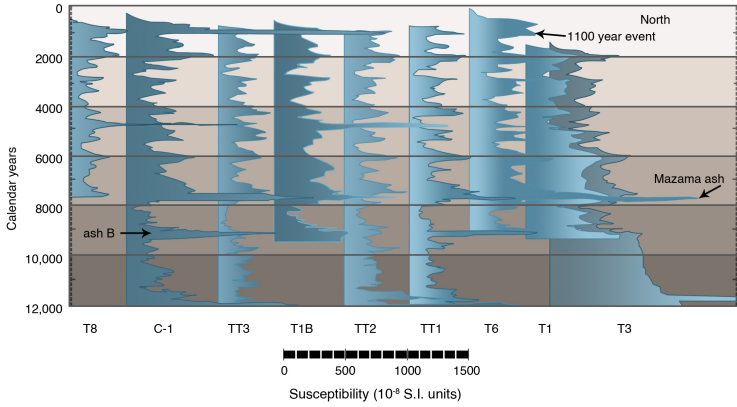

Figure 6-4 Tree rings from a 1,100-year-old tree dredged from the bottom of Lake Washington. Dark zone at top is the bark. Each pair of light and dark rings represents annual growth of one year. Photo by Gordon Jacoby, Columbia University



A video element has been excluded from this version of the text. You can watch it online here:

<https://open.oregonstate.education/earthquakes/?p=143>

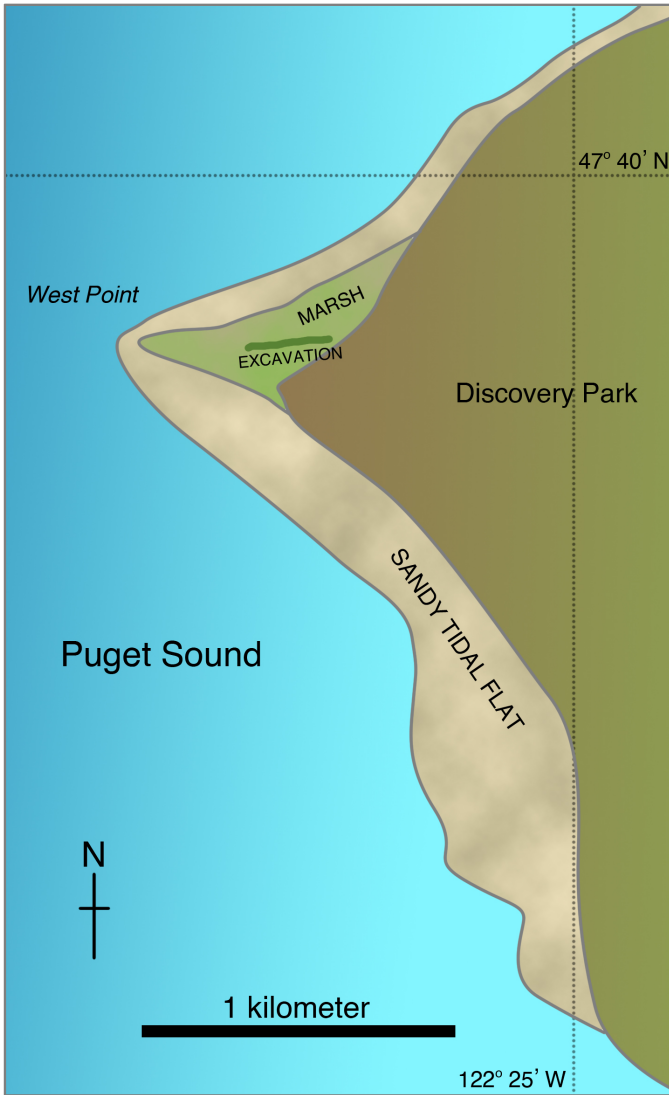

Figure 6-6. (a) Map of West Point area of Magnolia Bluff, Seattle,



---

*locating excavation depicted in Figure 6-6b (heavy line). Sandy tidal flat exposed only at very low tide. Discovery Park is an upland underlain by Pleistocene deposits. (1 km = 0.62 miles)*

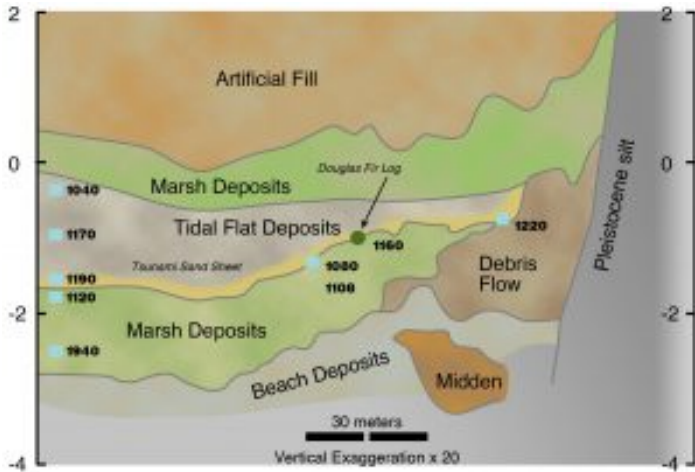

Figure 6-6b. Log of walls of excavation for sewer line. Shaded squares locate samples for radiocarbon dates, which are given in radiocarbon years before 1950 A.D., with laboratory error bars  $\pm$  50 to 80 years. Beach deposits at least two thousand years old contain a midden where people had built fires and thrown away shells. This is overlain by a marsh deposit containing marsh grass stems in growth position; this is in turn overlain by a sand sheet deposited by a tsunami. Sand sheet contains a Douglas fir driftwood log radiocarbon dated to A.D. 900-930 with tree rings indicating the tree was killed in the same season as trees in the sunken forests of Lake Washington. The sand sheet is overlain by tidal-flat deposits similar to those exposed today only at very low tide. This indicates sudden subsidence of the ground by about three feet (one meter). The tidal-flat deposits are overlain by another marsh deposit similar to that preserved beneath the sand sheet; this marsh persisted into the twentieth century, when it was covered by artificial fill. Photo by Robert L. Schuster, USGS. Modified from Brian Atwater and A. L. Moore, USGS.

---

The next clue in the detective story came from the shore of Puget Sound, near the lighthouse at West Point, in Discovery Park in the Magnolia District of

Seattle (Figure 6-6a). Workers there were excavating for a sewer line when they found an unusual archaeological site: an ancient beach where early inhabitants had built fires and thrown away shells. The beach deposit was overlain by a salt-grass marsh deposit, which was itself overlain by a sand layer containing a Douglas fir driftwood log (Figure 6-6b). Brian Atwater of the USGS was called in, and he concluded that the sand and the driftwood log were deposited by a great wave, or tsunami. High-precision radiocarbon dates of the outer layers of the driftwood log are A.D. 900-930, close to the age of the enclosing sand layer, hence the age of the tsunami that deposited it. The marsh deposit could have been suddenly downdropped by an earthquake, like the marsh deposits Atwater had been studying on the Washington coast. A similar tsunami sand deposit was uncovered to the north at Cultus Bay, at the southern end of Whidbey Island. The sand deposits were dated and found to have been deposited by a tsunami one thousand to eleven hundred years ago—about the same time as the landslides and the sediment layer in Lake Washington.

Atwater asked Gordon Jacoby to look at tree rings on the driftwood log. Jacoby found that the tree-ring pattern was a perfect match with the tree rings from the sunken forests of Lake Washington: *the same season of the same year!* That meant that the tsunami in Puget Sound and the landslides in Lake Washington happened at the same time. What could cause both events? The most logical explanation: both were triggered by a

single large earthquake. But a subduction-zone earthquake was ruled out: these features were too far to the east.

Meanwhile, Bob Schuster of the USGS was working in the southeast Olympic Peninsula, looking at dead trees that had been drowned in mountain lakes dammed by rockslides (Figure 6-7). Radiocarbon dates of these drowned trees indicate that three or four out of six rockslides that he studied could have been deposited at the same time, between one thousand and thirteen hundred years ago. No rockslides this large have happened in historic time, not even during the earthquake of magnitude 7.1 that struck Puget Sound in 1949. Schuster concluded that the rockslides might have been triggered by shaking accompanying a large earthquake of much higher intensity than the 1949 earthquake.



*Figure 6-7. Drowned snags breaking the surface of Jefferson Lake in southeastern Olympic Peninsula at low water level. The rock avalanche dam, partially covered by a modern forest, forms the far shore of the lake. Note the large boulders at the toe of the rock avalanche on the lake shore at the right.*

Farther west, Brian Atwater was studying the sediment at the mouth of the Copalis River, north of Grays Harbor on the southwest side of the Olympic Peninsula. This was part of his work on Pacific coastal marshes overwhelmed by subsidence accompanying subduction-zone earthquakes. Sure enough, just as he had found in other coastal marshes, the buried soils were consistent with sudden subsidence—except for one, which showed no evidence for subsidence and was unique in that it was accompanied by sand erupted from a fissure several hundred feet long. The soil was

older than the buried marshes related to the last subduction-zone earthquake; between nine and thirteen hundred years rather than three hundred years. Perhaps the vented sand could have accompanied an earthquake in the crust.

Were all these features formed by the same earthquake about eleven hundred years ago? If they were, could the fault producing the earthquake be identified? Bob Bucknam of the USGS came up with a candidate fault that had been previously identified by Howard Gower and Jim Yount, also of the USGS. The evidence was found at Restoration Point, which juts into Puget Sound at the south end of Bainbridge Island, within sight of the tall office buildings of downtown Seattle (Figure 6-8). Above the present tide pools on the modern marine platform is an older marine platform, sloping seaward, which had been raised suddenly as much as twenty-one feet some time between five and seventeen hundred years ago, based on radiocarbon dating. A few miles to the north, near the ferry landing at Winslow, sediment of the same age showed evidence of subsidence. Could the difference in uplift be signs that the fault identified by Gower and Yount have uplifted Restoration Point and downdropped the Winslow ferry landing site?



*Fig. 6-8. Restoration Point, east end of Bainbridge Island, west of downtown Seattle. Modern wave-cut platform is overlain by a higher platform that was uplifted by as much as 21 feet some time between five and seventeen hundred years ago.*

Across Puget Sound in West Seattle, there is another uplifted platform at Alki Point very similar to the one at Restoration Point, but harder to work out due to the presence of houses. And to the north at West Point in the Magnolia District, where the tsunami deposit and driftwood log were found in Discovery Park, the sediment had subsided (Figure 6-6b). If the same fault passed between Alki Point and West Point, it would trend east, crossing downtown Seattle beneath the Alaskan Way Viaduct and crossing beneath Lake

Washington north of the Floating Bridge. Bucknam called this structure the Seattle Fault (Figure 6-9).

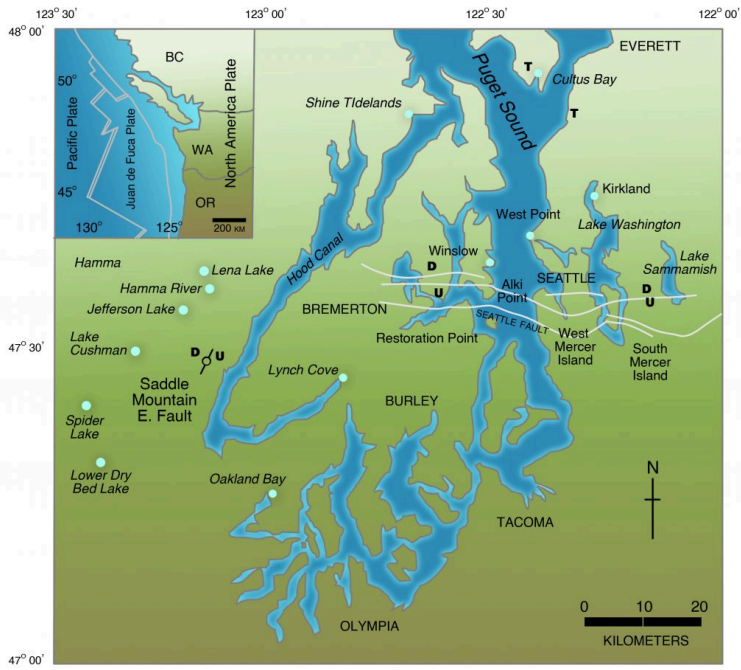

Figure 6-9. The Seattle fault. U means upthrown side, D means downthrown side. Filled upright triangle: uplifted tidal platform; filled upside-down triangle: subsided tidal-marsh deposit; filled circle: tidal-marsh deposit showing no evidence of subsidence; T: tsunami deposit; filled square: rock avalanche; open square: submarine landslide in Lake Washington. Saddle Mt. E. Fault identified as active by J. Wilson and R. Carson. Modified from Robert Bucknam, USGS

The bedrock geology provides support for such an east-trending structure. Bedrock is found at the surface in the southern part of Seattle, including Alki Point,



Seward Park, Rainier Valley, Beacon Hill, and the Newcastle Hills between Renton and Issaquah, east of Lake Washington. But to the north, including West Point, where subsidence was documented, Gower and Yount had found that bedrock is buried to depths of two to three thousand feet. This indicated that the long-term subsidence over hundreds of thousands of years was in the same direction as the subsidence across Bucknam's Seattle Fault on both sides of Puget Sound.

For a more detailed look at the structure beneath the surface of the ground, Bucknam and his colleague, Sam Johnson, also of the USGS, obtained seismic-reflection profiles acquired by the petroleum industry in the search for oil and gas in the Puget Sound area (Figure 6-10). These were supplemented by USGS marine seismic surveys obtained by Tom Brocher along the waterways of Puget Sound from the San Juan Islands to Olympia and studies by USGS's Rick Blakely of the Earth's magnetic and gravity field throughout the Puget Sound region. These studies confirmed that an east-trending fault crosses this area about where Gower, Yount, and Bucknam predicted it should do so. Unfortunately for our earthquake search, there is no fault at the surface. Bucknam and Johnson concluded that this fault was "blind," that is, it *never* made it to the Earth's surface at Seattle (Figure 6-10). In this respect, it was like the blind fault beneath the San Fernando Valley, California, that ruptured during the 1994 Northridge Earthquake.

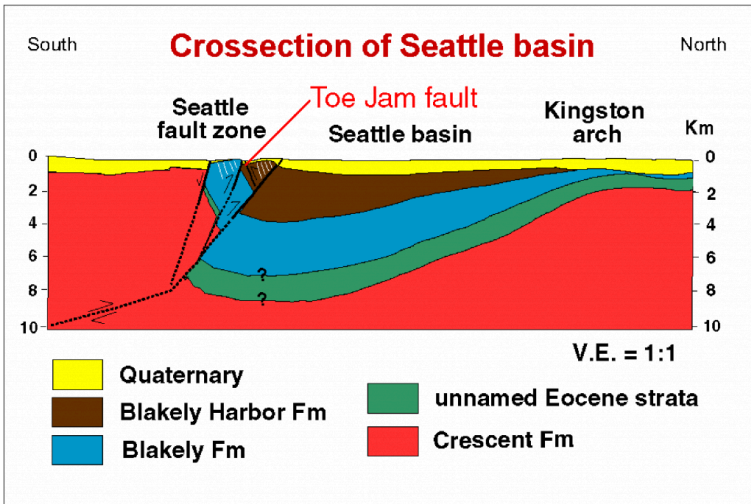

Fig. 6-10. Cross section of Seattle fault, showing that the north side is downdropped as part of the Seattle basin, and the south side is uplifted, with bedrock close to the surface. This is evidence that the deformation around 1100 years ago was part of long-term deformation of the Seattle region.

The evidence indicates that the Seattle Fault was the source of an earthquake around A.D. 900-930 based on the radiocarbon age of the outermost tree rings of the driftwood log at West Point. This fault extends from Bainbridge Island across downtown Seattle to Lake Washington and Lake Sammamish, where another sunken forest was found (Fig. 6-9). Shaking accompanying the earthquake caused forested regions next to Lake Washington and Lake Sammamish to slide into the lakes, and large rockfalls on the Olympic Peninsula to block several mountain valleys, producing

lakes. During the earthquake, the land rose up at Restoration Point and Alki Point and subsided farther north. Uplift of the floor of Puget Sound generated a great sea wave that struck the coastline at Magnolia Bluff, at the south end of Whidbey Island, and at the mouth of the Snohomish River delta near Everett. The amount of uplift at Restoration Point led to an estimate of magnitude 7 for the earthquake.

Were this earthquake to repeat today, the losses would be catastrophic. The fault extends beneath the most expensive real estate in the Pacific Northwest in an area inhabited by more than a million people, many living in houses built before the development of modern earthquake building codes. Unlike the earthquake of magnitude 7.1 that struck Olympia in 1949 that originated at depths greater than thirty miles, this earthquake would have its focus within ten to fifteen miles of the surface, so that shaking would be much more intense, comparable to or greater than the strong shaking of the 1994 Northridge, California, and 1995 Kobe, Japan, earthquakes.

Did Native Americans record the Seattle Fault Earthquake eleven hundred years ago? Ruth Ludwin of the University of Washington has been collecting oral traditions including a story about the horned serpent, Psai-Yah-hus, a spirit that lived underground and caused landslides and earthquakes. The locations of some of these tales line up along the Seattle Fault. In addition, the origin of Agate Pass at Bainbridge Island has been attributed to a climactic battle between the

Giant Serpent and the spirit power of Chief Kitsap, the Double Headed Eagle.

### **3. Other Active Faults in the Puget Sound Region**

The high crustal seismicity of the Puget Sound region is a clue that there should be additional active faults. The search for these faults faces two problems. First, much of the region is covered by dense forest and underbrush so that from the air, one cannot see small landforms like fault scarps as one could in semi-arid eastern Washington. Second, the region was buried by glacial ice similar to that found today in Greenland as recently as 14,000 years ago. During advance and retreat of the glacier, deposition and erosion erased subtle tectonic features, removing any evidence for active faulting older than latest Pleistocene.



Figure 6-11. Puget Sound region consists of basins (thin dashed lines with tick marks) filled with soft Quaternary sediments that tend to amplify seismic waves; these include the Tacoma Basin, Seattle Basin, Everett Basin, and Port Townsend Basin. Basins are bounded by faults (dotted lines), some of which are active (heavy solid lines) based on LiDAR imagery and surface geologic evidence that they cut late Quaternary deposits. Curved lines with arrows mark the paths of lahars (volcanic mudflows) that have traveled down valleys from Mount Rainier. DDMF, Darrington-Devils Mountain Fault; SF, Seattle Fault; SWIF, Southern Whidbey Island Fault; TF, Tacoma Fault. Based on work by USGS



Figure 6-12. LiDAR image of the Toe Jam Hill Fault on the south end of Bainbridge Island. In contrast to the Seattle Fault, the scarp of the Toe Jam Hill Fault faces south. The marine terrace uplifted by movement on the Seattle Fault farther north is not offset by the Toe Jam Hill Fault. The fault scarp is superimposed on linear grooves in the topography formed by Pleistocene glaciers. Image courtesy of Ralph Haugerud and Brian Sherrod, USGS

---

However, in the 1970s, prior to the discovery of the Seattle Fault, Joseph Wilson, a graduate student at North Carolina State University at Raleigh, and Bob Carson of Whitman College in Walla Walla, Washington, found evidence for four faults in the southeastern Olympic Peninsula between Lake Cushman and Hood Canal with evidence for Late Quaternary displacement. Radiocarbon dating shows that the latest movement on one of them, the Saddle Mountain East Fault, took place around 1,240 years ago.

The general tectonic outline of the Puget Sound region worked out in the 1980s by Howard Gower and James Yount of the USGS (Figure 6-1) showed other faults in addition to the one marking the boundary between an uplifted area in south Seattle and south Bainbridge Island and a thick basin of young sediments to the north, which would later be called the Seattle Fault and Seattle Basin. In the 1990s, Sam Johnson, Tom Brocher, Rick Blakely, and their USGS colleagues described other basins: the Tacoma Basin to the south and the Everett and Port Townsend basins to the north. They proposed that several of these basins were bounded by active faults (Figure 6-1).

To convince skeptics like myself who thought that, except for the Seattle Fault, the case for active faulting had not been made, more evidence was needed. It was necessary to part the obscuring veil of dense second-growth forest that covered subtle fault scarps that might have formed since the glaciers melted away.

The solution came from LiDAR (Light Detection And Ranging), a new method of imaging the ground using a laser beam reflected by a spinning mirror in a light airplane to penetrate the tree canopy. A LiDAR flight had been commissioned by the Kitsap Public Utility District to study groundwater infiltration and runoff on Bainbridge Island. North of Toe Jam Hill, on the south end of the island, the survey imagery found an unexpected surprise: an east-west-trending fault scarp that became known as the Toe Jam Hill Fault (Figure 6-11). Backhoe trenches across the fault scarp (Figures

6-12, 6-13) revealed evidence for not just one earthquake around eleven hundred years ago, but three and possibly four earthquakes between twenty-five hundred and a thousand years ago. The most recent earthquake is probably the one that raised Restoration Point in A.D. 900-930. The scarp of the Toe Jam Hill Fault faces south, in the opposite direction from the blind Seattle Fault to the north, suggesting that the Toe Jam Hill Fault intersects the Seattle fault at a shallow depth and is secondary to it (Figure 6-10).

More recent LiDAR surveys have found additional post-glacial fault scarps at Toe Jam Hill (Figure 6-11), on a fault south of the Darrington-Devils



*Fig. 6-13. Trench excavation being described across Toe Jam Hill fault on Bainbridge Island. Source: USGS.*

Mountain Faults, on the Tacoma Fault, and in the southeastern Olympic Peninsula, where Wilson and Carson had worked (Figure 6-1). Post-glacial fault scarps were also found on the northern margin of the Olympic Mountains, and west of the Toe Jam Hill Fault on the Kitsap Peninsula. The Southern Whidbey Island Fault (SWIF, Figure 6-1), which comes ashore south of Everett, underwent displacement of one to two meters on Whidbey Island three thousand years ago. This fault may be the longest active fault in the Puget Sound region, possibly capable of an earthquake even larger



than that proposed for the Seattle fault. It is traced southeastward into the Cascade foothills, and it may influence the location of Snoqualmie Falls. A regional wastewater treatment plant has been built by Seattle Metro across the fault in southern Snohomish County north of Woodinville, despite protests from homeowners living nearby. The slip rate is likely to be low in comparison with the subduction zone, thereby reducing the likelihood that it will rupture during the life of the treatment plant.

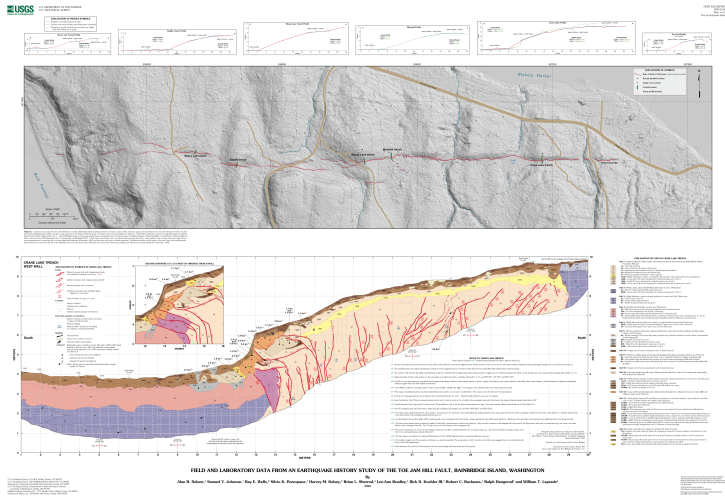

Fig. 6-14. Log of west wall of Toe Jam Hill trench showing the fault scarp (Figure 6-10) and several fault strands with evidence of additional earthquakes besides the event 1100 years ago. The inset shows the east wall of the trench at the Toe Jam Hill fault, inverted to facilitate comparison with the west wall. Source: USGS.

In the Snohomish River delta near Everett, Joanne Bourgeois of the University of Washington and Sam Johnson of the USGS found evidence for at least three earthquakes and one tsunami. The tsunami deposit appears to be related to the earthquake on the Seattle Fault in A.D. 900-930. The most recent earthquake is dated between A.D. 1430 and 1640, younger than any other earthquakes in the Puget Lowland identified by paleoseismology and not too much earlier than the historical record. Vented sand found by Steve Obermeier of the USGS in overbank deposits of rivers near Centralia, Washington, appears to be related to a crustal earthquake south of Puget Sound, but the surface fault source for this earthquake has not been identified.

Puget Sound has been the target of focused studies of active faults in part because that's where the people live who are at risk. Are we likely to find a similar concentration of active faults elsewhere? The high crustal seismicity of the Puget Sound and south Georgia Strait region suggests that this region is special. Confirmation comes from the GPS network, which had already confirmed the earlier land-based geodetic survey data that most of the compression is north-south. Stephan Mazzotti of the Pacific Geoscience Centre found that there is active crustal shortening between the south end of Puget Sound near Olympia and the Strait of Juan de Fuca as far north as Victoria. If one takes out the elastic deformation marking the buildup toward the next Cascadia

Subduction Zone earthquake, this region is being squeezed together at about a quarter inch (six millimeters) per year. So the answer is: yes, there is something special about the weaker crust of northwestern Washington.

When will the next big crustal earthquake strike? The answer to this question is unknown, but some questions may now be asked. First, the time around A.D. 900 must have been characterized by many violent crustal earthquakes, perhaps leading to the horned serpent stories of Native Americans. Was there only one huge earthquake extending from Copalis River to Lake Sammamish, or was there a cluster of earthquakes? The earthquakes recorded on the Toe Jam Hill Fault and in the Snohomish River delta suggest a cluster of earthquakes. (An example of a historical cluster is found in western Nevada, where large earthquakes struck in 1903, 1915, 1932, 1934, and four in 1954, although the recurrence interval on any given fault there is measured in thousands of years.)

Does the active faulting of a millennium ago mean that more crustal faulting is due soon? We don't know.

Now and then, a moderate-size crustal earthquake strikes the Puget Sound region. On April 14, 1990, an earthquake of magnitude 5.2 struck near the town of Deming, east of Bellingham. On May 2, 1996, a magnitude 5.3 earthquake had its epicenter a few miles east of the small town of Duvall, in the foothills of the Cascades northeast of Seattle. It resulted in only minor damage, and its main claim to fame was that it caused

the evacuation of the Kingdome during a Seattle Mariners baseball game. The previous year, on January 28, a magnitude 5 earthquake struck the southern Puget Sound region north of Tacoma. Earthquakes such as these are likely to occur anywhere west of the Cascades, although they are more likely in the Puget Sound region. They rate a newspaper story for a day or so, a story which usually gives off a whiff of impending doom, but earthquakes like these do little damage. It is impossible to assign them to a specific fault.

We will revisit the problem of forecasting the next crustal earthquake in the following chapter.

## 4. Earthquakes and Cascade Volcanoes

The reawakening of Mt. St. Helens began on March 20, 1980, with an earthquake of magnitude 4.2 followed by a crescendo of earthquakes that rose to a peak on March 27, then decreased in number as the time of the climactic eruption approached. Many of these earthquakes were due to the passage of magma far beneath the surface and not the rupture of faults. (A comparison would be a growling stomach versus a stick breaking.) An earthquake of magnitude 5.1 on the morning of May 18 led to the collapse of the north side of the volcano and a hot avalanche that swept down the valley of the Toutle River. In addition to the avalanche, a mudflow (called by the Indonesian word

*lahar*) continued down the valley and beneath the bridge at Interstate 5, partially burying houses in the town of Castle Rock. In the following year, the Elk Lake tectonic earthquake of M 5.5 was characterized by right-lateral strike-slip faulting. This earthquake was part of a linear north-northwest-trending band of earthquakes called the St. Helens Seismic Zone in which most of the earthquake fault-plane solutions are right-lateral strike slip. This seismic zone has not been correlated to a known surface fault.

Farther north, a north-south-trending band of earthquakes is located west of the summit of Mt. Rainier, icon of Seattle and Tacoma, exuding menace as well as scenic grandeur. Mt. Rainier showed signs of eruptive activity in the nineteenth century, and it has been the source of debris flows and glacial outburst floods. These flows have been limited to the mountain itself, but two prehistoric lahars swept down river valleys into areas that now have large populations (Figure 6-1). The largest of these, the Osceola Mudflow, swept down the White River valley forty-five hundred to five thousand years ago and reached Puget Sound more than sixty miles away. Five hundred years ago, a smaller lahar, the Electron Mudflow, coursed down the Puyallup River valley as far as the town of Orting, thirty miles from the volcano, in less than thirty minutes. Cities at risk from future mudflows include Auburn, Kent, Puyallup, and even Tacoma. Some houses in these cities are built directly on these mudflow deposits.

Pierce County, the region at greatest risk from lahars,

has developed a lahar warning system in cooperation with the USGS Cascade Volcano Observatory in Vancouver. Specially designed acoustic flow monitors at Mt. Rainier would detect a lahar as it begins. This would trigger an array of sirens throughout the Puyallup and Carbon river valleys alerting residents to follow predetermined marked evacuation routes to higher ground, out of the path of the lahar. The time between identification of the lahar and sounding of the warning sirens is less than two minutes. If you live in the path of these mudflow deposits, contact Pierce County Emergency Management for details.

No relation between tectonic earthquakes and these mudflows has been demonstrated. The 1981 Elk Lake Earthquake struck the St. Helens Seismic Zone *after* the climactic eruption, not before. However, it is likely that the first signs of a future volcanic eruption will be registered on seismographs, as was the case for Mt. St. Helens in 1980.

## 5. The Portland Hills Fault

Sixteen million years ago, great floods of basaltic lava issued from crustal fractures in easternmost Washington and Oregon and western Idaho and poured across the Columbia Plateau in a broad front, hemmed in only by the Cascades, through which the lava burst in a fiery flood more than twenty miles across to enter

the northern Willamette Valley and finally to flow into the sea. These lava eruptions have no counterpart in human history. One cannot imagine looking toward an advancing front of molten basalt extending from horizon to horizon, from the Columbia River at Portland south to the Waldo Hills east of Salem, Oregon, flowing faster than one could ride a horse, almost like water. This happened not just once but dozens of times over several million years.

Long after the basalt lava had frozen into stone, less than a hundred thousand years ago, there was a different kind of catastrophe. During the Pleistocene, the interior of British Columbia was covered by a vast ice cap, like Greenland today, and glaciers had advanced southward into northern Washington, damming the Columbia River and its tributaries at Spokane to form a huge body of fresh water, Glacial Lake Missoula, that extended across Idaho into Montana, almost to the Continental Divide. At the end of the Pleistocene, the glaciers began to melt and retreat, and the ice dam at Spokane suddenly ruptured. The lake drained first beneath the ice, then floated the ice roof and caused it to collapse. The resulting iceberg-strewn deluge, lasting at least a week, drained Lake Missoula, briefly carrying more water than all the streams on Earth do today.

Nothing else on Earth matched this apocalyptic Missoula flood. The great volume of water was too much for the valley of the Columbia River, and water rushed across the Columbia Plateau, ripping away the

rich Palouse soil and eroding down to the bare basalt, forming a broad wasteland called the Channeled Scablands. The thundering torrents carved out the Grand Coulee and Dry Falls and deposited giant sandbars on the Columbia River below Wenatchee, so large that they can be seen from space. Like its basaltic predecessor millions of years before, the water flowed out across a broad front. The doomsday scenario repeated itself many times as the ice cap retreated, then advanced, then retreated, over and over again. The last time was about twelve thousand years ago.

Satellite images of the Portland metropolitan area show the effects of these giant floods, scouring out the bases of Pleistocene volcanoes and carving canyons through the basalt mountains, one now occupied by Lake Oswego, a Portland suburb (Figure 6-11). For the geologist looking for active faults, the effect is the same as the grinding of glaciers in Puget Sound: the floods erased any evidence of active fault scarps older than twelve thousand years as far south as Eugene.

Yet there is one feature that is hard to miss: the straight-line base of the Portland Hills in downtown Portland (Figure 6-15). The hills are underlain by Columbia River Basalt, arched upward into an anticline, that may be related to the origin of Willamette Falls at Oregon City. The late Marvin Beeson of Portland State University described the Portland Hills structure and fault, which is more or less parallel to the St. Helens Seismic Zone to the north and the Mount Angel Fault to the south, both suspected of being right-lateral strike-



slip faults. For a long time, proof of its activity was lacking, although for earthquake hazard planning exercises, it was assumed to be capable of an earthquake of magnitude greater than 7, the most dangerous fault in Oregon aside from the subduction-zone fault.

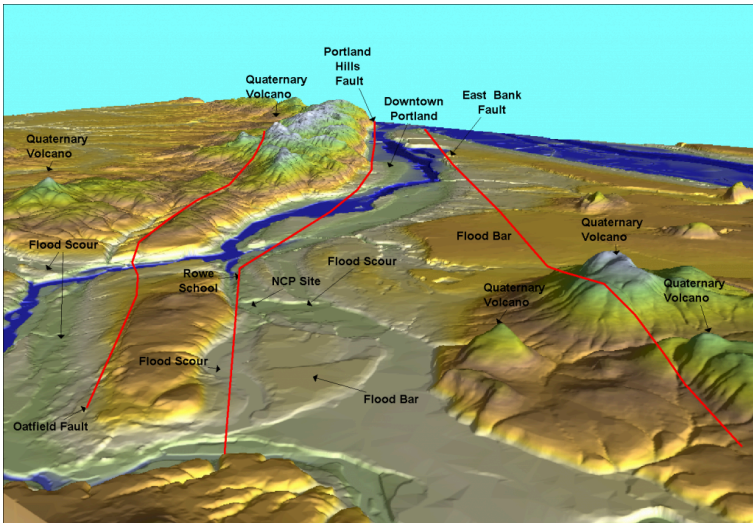

Figure 6-15. Computer-generated topographic image of downtown Portland, Oregon, looking northwest. Curved black bands show the Willamette River and, in the upper right, the Columbia River. Isolated, conical peaks are Quaternary volcanoes, which are not known to pose a volcanic hazard. The low topographic features in Portland were strongly modified by the Missoula Floods that scoured through the area fifteen thousand to twelve thousand years ago. The linear range front of the Portland Hills marks the position of the Portland Hills Fault, which has been shown to be active based on evidence at Rowe Middle School and North Clackamas Park (NCP site). The Portland Hills Fault and adjacent East Bank Fault to the east and Oatfield Fault to the west are shown as curving solid lines; they show that the Portland Hills structure occupies a zone of faulting and is not a single feature. Image courtesy of Ian Madin, Oregon Department of Geology and Mineral Industries

Ivan Wong of URS Greiner and Associates and Ian Madin of the Oregon Department of Geology and Mineral Industries decided to look for the smoking gun that would show if the fault is active or not. Seismic surveys along the Willamette River by Tom Pratt of the USGS and Lee Liberty of Boise State University provided hints that the fault cuts the latest Pleistocene Missoula flood deposits. These distinctive deposits are rhythmically bedded, with each bed deposited by one of the catastrophic Missoula floods in the latest Pleistocene. A detailed seismic survey in North Clackamas Park southeast of Milwaukie (NCP, located on Figure 6-14) provided evidence that the flood deposits may be deformed. Then somebody noticed a retaining-wall excavation at Rowe Middle School, not far from North Clackamas Park. In this excavation, the Missoula flood deposits are clearly folded. The first Oregon fault west of the Cascades could now be classified as possibly active.

In addition, excavations for an expansion of the Oregon Convention Center showed Missoula flood deposits that are cut by sand dikes, generally considered to be formed by liquefaction, diagnostic for an earthquake origin. However, could these dikes have been produced by a subduction-zone earthquake? Could they somehow be related to the massive amount of water that repeatedly covered the area in the latest Pleistocene? Preliminary examination of excavations around Portland suggests only one episode of sand dike formation, suggesting to me that they formed during

one high-intensity crustal earthquake rather than repeated subduction-zone earthquakes or repeated flooding episodes. However, this is not “smoking gun” evidence.

Geophysical studies by Rick Blakely and his colleagues at the USGS revealed two additional faults parallel to the Portland Hills Fault, the East Bank Fault following the east side of the Willamette River to Mt. Scott, an inactive Quaternary volcano, and the Oatfield Fault on the west slope of the Portland Hills extending southeast to Lake Oswego and Gladstone (Figure 6-14). So, like the Seattle Fault, the Portland Hills Fault is a broad zone of faulting rather than a single fault. However, it is poorly located, even in downtown Portland.

Portland has an earthquake history, with the largest number of earthquakes recorded anywhere in Oregon. Partly this is an accident of early settlement of the Portland Basin. An earthquake on October 12, 1877, resulted in intensities as high as VII in Portland. Lower-intensity earthquakes were recorded in Portland on February 3, 1892, December 29, 1941, and December 15, 1953. The best-studied earthquake struck on November 5, 1962, with an epicenter near Vancouver and a magnitude of 5.2 to 5.5. This earthquake caused minor damage, including fallen chimneys and broken windows.

## 6. Earthquakes at the End of the Oregon Trail: Willamette Valley

Fifty million years ago, northwest Oregon was a low coastal plain, with the shoreline close to the western edge of the present Willamette Valley, extending northwestward toward Astoria into what would one day become the Coast Range. East of the shoreline, rivers deposited clean sand, and in their floodplains were broad swamps and marshes, like the tropical Pacific coast of Guatemala today. Over the next few million years, the sand and the organic deposits of the swamps were slowly buried beneath younger deposits, and the organic materials began to turn into coal and generate natural gas. The rock layers containing the coal and the sand were tilted, folded, and faulted. North of the Columbia River, the buried swamp deposits of this ancient tropical coast would form the major resource for a coal-mining industry in western Washington. South of the Columbia, the economic potential of these deposits was still unrealized.

Near the backwoods village of Mist, Oregon, Chuck Newell had a dream. As a geologist for Shell Oil Company and later as an independent consultant, Newell had slogged up the brushy creeks and barren clearcuts of the northern Coast Range, and he slowly pieced together an idea about the hidden geologic

structure. Maybe the gas from the swamp deposits had migrated into the river sand, now hardened into sandstone. Maybe there was a gas field beneath a broad uparched anticline that Newell had mapped beneath the alder and devil's club jungle of the Coast Range.

This seemed a far-fetched idea because no one had ever discovered commercial quantities of oil or gas in Oregon or Washington, despite nearly a century of exploration. However, Newell convinced Wes Bruer, his former classmate at Oregon State University and a geologic consultant for Reichhold Chemical Company, that the Mist Anticline might contain commercial quantities of gas. Reichhold had purchased the Phillips urea plant at St. Helens, Oregon, and the plant required about nine million cubic feet of gas per day as raw material feedstock for the production of urea. Accordingly, Reichhold was persuaded to drill a well, and the Mist gas field was discovered. Overnight, Oregon had a local source of natural gas, the first in the Pacific Northwest.

As soon as the word was out, lease brokers fanned out across the Willamette Valley talking to grass-seed farmers and timber owners. Geophysical trucks laid cable and geophones along country roads and through pastures for seismic surveys. Wildcat wells were drilled in the region from Hillsboro to Eugene.

Alas, there were no more Mist gas fields, and the oil and gas boom crashed as quickly as it had started. But left behind were all the seismic surveys and wildcat well logs, which illuminated for the first time the complex

geology beneath the orchards and vineyards of the Willamette Valley, just as they had for the Puget Sound region to the north. There were folds and there were faults, including a fault extending along the northern foot of the Waldo Hills east of Salem, and another passing beneath the Benedictine abbey at Mount Angel (Figures 6-16 to 6-18). These faults had been discovered in the search for oil and gas. Could they be an earthquake hazard?

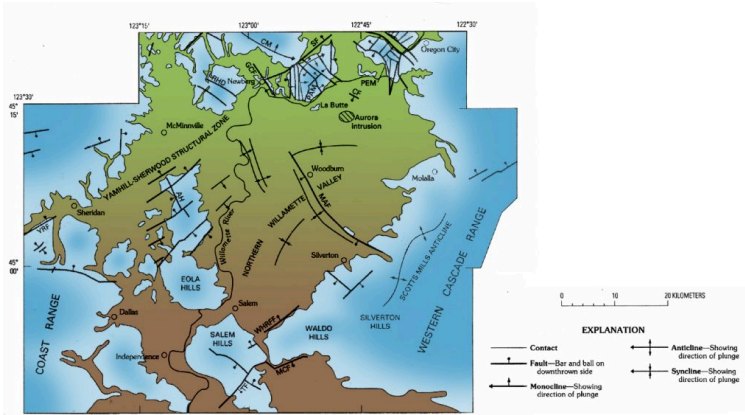

Figure 6-16. Tectonic map of the northern Willamette Valley, showing faults (lines with filled circle toward downthrown side) and folds: .anticlines (arrows face away from thin lines), synclines (arrows face toward thin lines), monoclines (single arrow faces away from thin lines) mapped based on seismic-reflection profiles and exploratory wells drilled in the search for oil and gas. MAF, Mount Angel Fault. Although the Mount Angel Fault later was blamed for the 1993 Scotts Mills Earthquake, it is not clear whether the other faults or any of the folds are active. Portland is just to the north of the figure. From Yeats et al. (1996) and mapping by Ken Werner

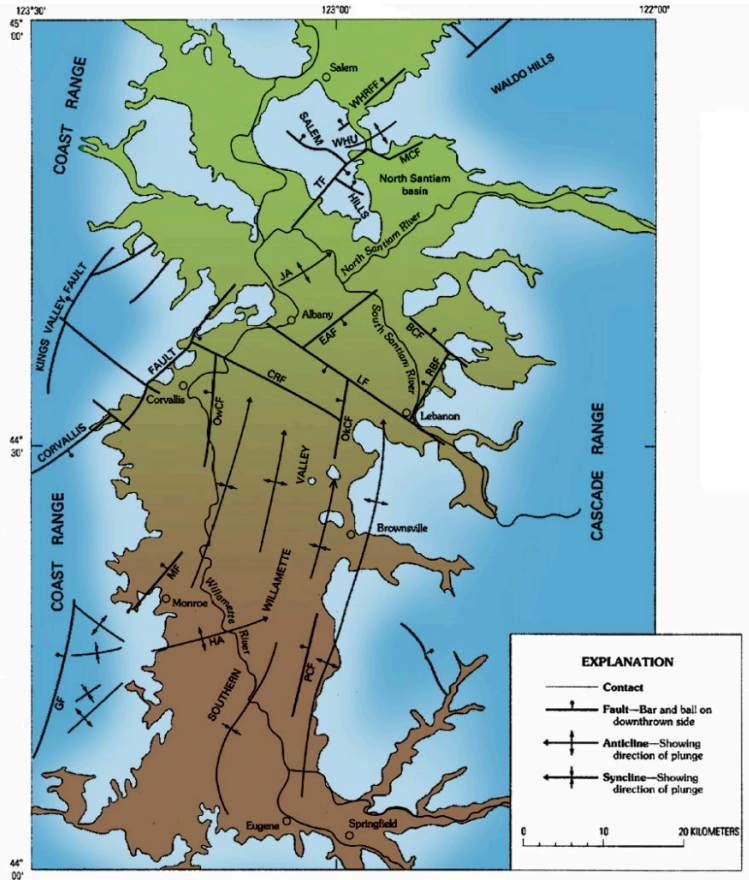

Figure 6-17. Tectonic map of the southern Willamette Valley, using a similar data set to that used for Figure 6-12. From Yeats et al. (1996) and mapping by Erik Graven

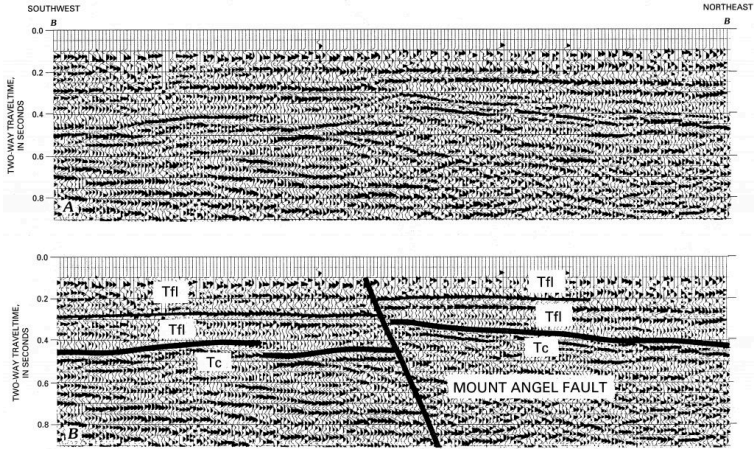

Figure 6-18. Seismic-reflection profile obtained in the search for oil and gas in the Willamette Valley. The horizontal lines are layers of rock beneath the surface that have been offset by the Mount Angel Fault. The bottom diagram is identical to the top one except it contains a geologic interpretation. Tc = Columbia River Basalt; Ttl = younger sediment filling the northern Willamette Valley. Photo by Ken Werner, Oregon State University, from Yeats et al. (1996)

Ken Werner, a graduate student at Oregon State University, collected the seismic surveys and well logs and mapped a subsurface fault extending from the Waldo Hills northwest beneath Mount Angel to the city of Woodburn near Interstate 5. In 1990, while Werner was working on his thesis research, seismologists John Nábelek of Oregon State University and Steve Malone of the University of Washington told him about a flurry of small earthquakes they had just recorded beneath Woodburn. Werner concluded that these earthquakes



were related to the subsurface Mount Angel Fault (Figures 6-16 to 6-18). In September 1992, Werner and his colleagues published a paper in *Oregon Geology*, a journal published by the Oregon Department of Geology and Mineral Industries, with a map of the fault and a discussion of the Woodburn earthquake swarm. Unknown to Werner, strain had been building up on the Mount Angel Fault beneath the Waldo Hills southeast of Woodburn and was already near the breaking point. The rupture came without warning six months later, at 5:34 a.m. on March 25, 1993, ten miles beneath the soft green hills east of the village of Scotts Mills, at the east edge of the Willamette Valley. In Molalla, eight miles north of the epicenter, José Alberto Nuñez felt the powerful rumbling and watched as his kitchen cabinets blew open, scattering glassware and dishes onto the kitchen floor. To the night crew at the Safeway store in Woodburn, fifteen miles northwest of the epicenter, the earthquake was a ground wave rolling beneath the floor, spilling out merchandise aisle by aisle. Ricky Bowers was driving across a bridge on State Highway 18 over the Yamhill River at Dayton, twenty-five miles away, when the bridge jumped off its supports, causing him to slam into the exposed concrete slab, blowing out all four of his tires. Fortunately, students were on spring break at Molalla Union High School, an unreinforced brick building constructed in 1925, where two gables on the exterior façade collapsed. The timing of the earthquake prevented serious injury to students, and school officials had only to worry about where classes

would be held the following week. A block away from the school, Philip Fontaine ran out into his front yard, carrying his young son. “The children were all screaming. Everything was just shaking and not stopping.”

At Mount Angel, ten miles to the west, there was major damage to the Benedictine convent and training center, the Benedictine abbey, and St. Mary’s church and school.

Commercial buildings in the historic downtown district of Woodburn were hit hard. Sharon Walsh, caretaker of the 102-year-old Settlemier Mansion, cowered as the house creaked and heaved, cracked and twisted, and she braced herself for a collapse. José Nuñez made it to his office at the Salud Medical Center in Woodburn only to find it in a shambles, with a gaping hole in the ceiling. In the town of Newberg, twenty-eight miles northwest of the epicenter, at least ninety buildings were damaged.

The State Capitol building in Salem, twenty-one miles away, had been declared vulnerable to an earthquake, with a price tag for seismic reinforcement of \$4 million. The Legislature chose not to act. The earthquake produced cracks inside the rotunda, which was closed indefinitely. Concrete fireproofing on the steel I-beams supporting the ceiling of the legislative chambers was damaged. High atop the Capitol, the ten-ton statue of the Golden Pioneer rocked and lurched, rotating a sixteenth of an inch, but miraculously did not fall from its pedestal.

Damage was estimated at more than \$28,000,000, with \$4,500,000 to the State Capitol alone. (The ultimate cost of retrofitting the Capitol was later estimated at more than \$67,000,000!) Surprisingly, there were no deaths. Injuries were limited to those from falling glass and bricks and to some of the employees of a large Walmart store overcome by fumes from bottles and cans of garden chemicals that had crashed to the floor. Unreinforced masonry buildings suffered a disproportionate share of the damage. The timing of the earthquake was fortunate: early in the morning during the week of spring vacation, preventing deaths at the unreinforced Molalla High School building. The fortunate timing gave the earthquake its name: the Spring Break Quake. Losses would have been much higher if the earthquake had struck one of the larger communities of the Willamette Valley rather than a rural area in the foothills of the Cascades.

Former senator Ron Cease of Portland, a member of the legislature at the time, may have said it best: not being able to walk beneath the rotunda on their way to work had an educational effect on Oregon's legislators in terms of earthquake hazards!

As shown in Figure 6-16 and 6-17, there are other faults in the Willamette Valley. The Corvallis Fault was mapped by Chris Goldfinger on the northwest side of the city of Corvallis in low hills slated for urban development. Despite considerable efforts, none of these faults can be shown to displace Holocene deposits (younger than ten thousand years).

Accordingly, we cannot state that these faults are active. The faults can be marked on the maps of areas being considered for urban development, and developers, local government, and potential buyers can make up their own minds about the potential for fault rupture. If you were considering purchase of a new house in the Willamette Valley, would you want to be told by local government that your house would be built on or close to a major fault, even though it could not be said that the fault was active or not?

## 7. Southwest British Columbia

Northern Vancouver Island just doesn't seem like Earthquake Country. The highway north of Victoria runs past small towns along the east coast of the island; it is lined with firs, with breathtaking views of the Georgia Strait, the Gulf Islands, and on a clear day, the snow peaks of the Coast Mountains. The road passes through Courtenay to Campbell River, past fishing villages and logging camps. One branch of the road crosses the Forbidden Plateau and Strathcona Provincial Park on its way to a lonely, storm-swept fjord below Gold River, on the Pacific Ocean side of the island.

This thinly populated region was the location of the largest crustal earthquakes in the short recorded history of the Cascadia region, an event of M 7.0 on

December 6, 1918 and a larger earthquake of M 7.3 on June 23, 1946 (located on Figure 6-19).

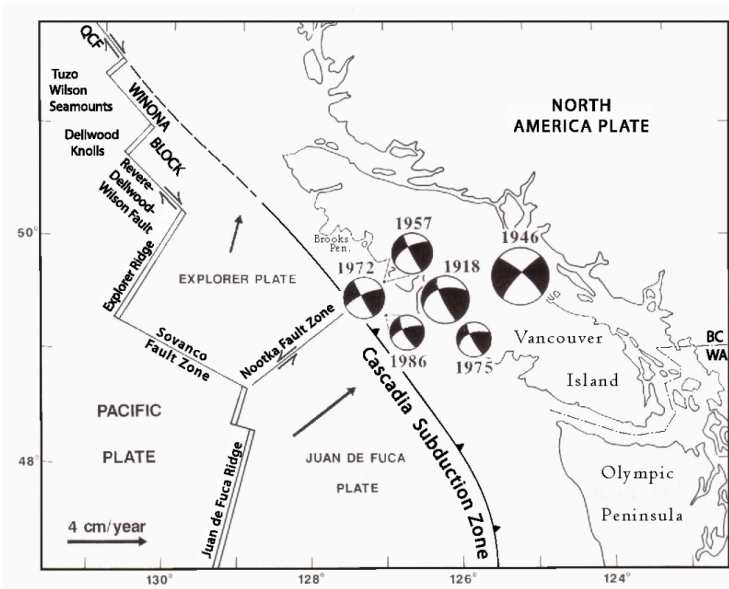

Figure 6-19. Earthquakes northeast of Nootka fault zone and central Vancouver Island. The Nootka fault zone separates the Juan de Fuca and Explorer plates. The beach-ball plots show that all earthquakes were due to left-lateral strike slip; larger earthquakes have larger beach balls. The 1918 and 1946 earthquakes were in North American continental crust. The 1946 earthquake was the largest recorded crustal earthquake in the Cascadia region. QCF: Queen Charlotte fault.

The 1946 earthquake produced extensive chimney damage in Campbell River, Courtenay, and Comox, and there were many landslides in the mountains and liquefaction and slumping of coastal sediment. Despite extensive areas of intensity VIII from Campbell River to

Courtenay, only one person was killed when his boat at Deep Bay was swamped by a wave, possibly generated by slumping of sediment into the water.

The 1918 earthquake struck along the primitive west coast of Vancouver Island, damaging the lighthouse at Estevan Point, south of Nootka Sound. The area of highest intensity was thinly populated, with widely scattered fishing villages accessible only by boat, and damage was slight. The focus of the earthquake was about ten miles deep, and intensities up to VI were recorded. It was felt as far away as Seattle and the town of Kelowna in the Okanagan Valley east of the Cascades.

The seismograms of both earthquakes, as recorded at distant stations, show that the motion was consistent with left-lateral strike slip on a crustal fault (or faults) striking northeasterly. This is the same strike as the Nootka Fault, a major left-lateral strike-slip transform fault on the deep ocean floor west of the continental slope, a fault that forms the boundary between the Juan de Fuca Plate and the Explorer Plate (Figure 6-19). However, the earthquakes are not located directly on the landward projection of the Nootka Fault but are offset about forty miles to the east.

The more heavily populated regions of Vancouver and Victoria experience quite a few small earthquakes, indicating that the region is a northern continuation of the seismically active crust beneath Puget Sound. This poses a dilemma for seismologists such as Garry Rogers of the Pacific Geoscience Centre in Sidney, B.C., concerned about estimates of seismic hazards in these

areas. Should Rogers and his colleagues consider that earthquakes as large as the 1946 event, M 7.3, are possible in Vancouver or Victoria, or anywhere else in the shallow continental crust of southwestern British Columbia? Or should they conclude that the large crustal earthquakes in central Vancouver Island are part of a zone that has an unusually high seismic hazard because of its proximity to the offshore Nootka Fault, thereby reducing the perception of hazard to Vancouver and Victoria? The answers to those questions are not yet at hand.

## 8. Eastern Washington and Northeastern Oregon

John McBride and his partner, Jack Ingram, were in trouble with the law. Contemporaries referred to them as “border ruffians . . . scoundrels who for pure cussedness could not be excelled anywhere on the border,” probably a compliment in the Washington Territory in 1872. Things had started out well; they had set up the first trading post in Wenatchee. But they were caught selling liquor to the Indians, and this got them arrested in Yakima. They bribed the prosecutor and were set free, but John McBride was then rearrested by federal marshals in Walla Walla, and he posted bond. He and Ingram had sold the trading post

and were living in a cabin west of the Columbia River near the Wenatchee River while awaiting trial.

In the early morning hours of December 15, 1872, they were awakened by a loud noise, as if the stove had fallen over. As they were pulling on their clothes, they were thrown to the floor, and they realized that they were experiencing an earthquake. They made their way to the Wenatchee trading post, six miles away, where they found the new owners in a state of confusion, with sacks of flour thrown about and damage to the roof and upper logs of the cabin and to the kitchen. Great masses of earth came down from the hills, and the gulches were filled with debris. A group of Spokane Indians crowded around the white settlers, crying out that the world was coming to an end.

North along the Columbia River, a fifteen-year-old Indian boy, Peter Wapato, told of a landslide at Ribbon Cliff near Winesap (present-day Entiat) that dammed the Columbia River for several hours. This landslide was also reported by the Indians to a settler, Elizabeth Ann Coonc, camped downstream. Decades later, geologist I. C. Russell of the USGS would describe this landslide at a place that became known as Earthquake Point. The Indians called it Coxit (Broken-off) Point.

Chilliwack and Lake Osoyoos, B.C., and Snoqualmie Pass and Kittitas Valley, Washington, reported intensities of VII. Port Townsend, Seattle, Olympia, Vancouver, and Walla Walla, Washington, and Victoria, B.C., experienced intensities of VI.

A century later, the 1872 earthquake was the subject



of great speculation because of plans for nuclear power plants by the Washington Public Power Supply System and Seattle City Light. The epicenter was variously located in the north Cascades, in the western foothills of the north Cascades, even in British Columbia, with magnitude estimates as high as 7.4. Bill Bakun of the USGS and his colleagues used the distribution of felt reports to locate the epicenter near Entiat and to estimate the magnitude as MI 6.8 (see Chapter 3 and Figure 2-6a), which made it the largest historical crustal earthquake in the Pacific Northwest except for Vancouver Island.

No source fault has been found. The eastern edge of the north Cascades near the Columbia River continues to be a source of small earthquakes, including an earthquake of M 5-5.4 on August 5, 1951, near Chelan. If there is something special about the Entiat region that should cause it to be more seismogenic than other areas, it is not known what it is.

On June 25, 2001, Spokane was rattled by a very shallow magnitude 3.7 earthquake that was followed by several aftershocks lasting into August. The distribution of the aftershocks suggested that they originated on a fault called the Hangman or Latah Creek fault, although no surface rupture related to these earthquakes was found. Such earthquakes are referred to as an *earthquake swarm*, in which there is a series of small earthquakes rather than a main shock. Another earthquake swarm was recorded in 1987 in the Columbia Plateau near Othello, Washington, with more

than two hundred events over a period of about a year. Like the 1872 earthquake, these could not be assigned to a specific fault.

The largest earthquake to strike northeastern Oregon shook the Milton-Freewater area shortly before midnight on July 16, 1936 (Figure 6-20). This earthquake has been given a magnitude as high as 6.1 and maximum intensity of VIII, although a recent study assigned it an intensity magnitude of MI 5.1 to 5.5 and maximum intensities of only VI. It was preceded by two foreshocks and followed by many aftershocks. Damage was reported in Milton-Freewater, Umapine, and Stateline, Oregon, and it was strongly felt in Walla Walla, Washington. Chimneys were damaged, houses were moved off their foundations, and liquefaction and landsliding were reported.



*A video element has been excluded from this version of the text. You can watch it online here:*

<https://open.oregonstate.education/earthquakes/?p=143>

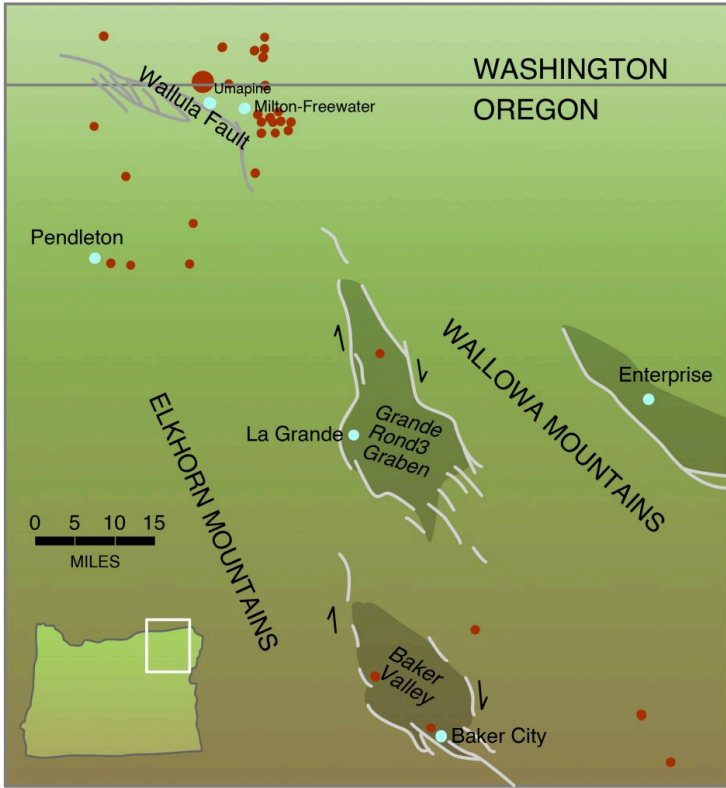

Figure 6-20. Faults in northeastern Oregon in the vicinity of the 1936 Milton-Freewater Earthquake. Shaded areas represent sediment-filled lowlands, including the fault-bounded Grande Ronde Graben and Baker Valley. Solid circles represent earthquakes, with the largest circle the Milton-Freewater Earthquake. This earthquake struck close to the Wallula Fault, but there is no evidence that this fault ruptured the surface during the earthquake. This area is classified as having relatively low seismic hazard by the USGS. Faults and earthquakes from Gary Mann, USGS



A video element has been excluded from this version of the text. You can watch it online here:

<https://open.oregonstate.education/earthquakes/?p=143>

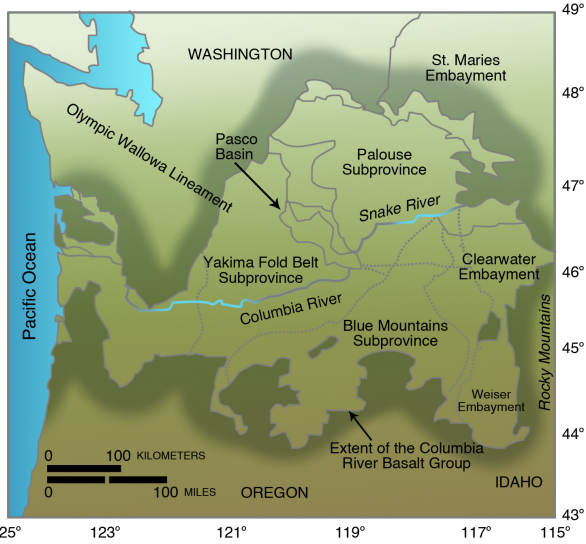

Figure 6-21. (Top) Tectonic map of Yakima Fold Belt, including the Hanford Reservation. Anticlines (arrows facing away from solid lines) are upfolded ridges of Columbia River Basalt that may be underlain by blind faults that could be the sources of earthquakes. (Bottom) Regional map showing location of Yakima Fold Belt and the Olympic-Wallowa Lineament and the distribution of the Columbia River Basalt. Olympic-Wallowa Lineament may have been formed by regional strike-slip faulting that could generate earthquakes. The southeastern part, in Oregon, includes the faults shown in Figure 6-15.

---

As in the previous examples, no source fault was immediately found. But in this case, a possible culprit has been identified: the Olympia-Wallowa Lineament, otherwise known as the OWL (Figure 6-21). This subtle structural alignment can be traced from the Olympic Peninsula across the Cascades and Hanford Reservation to the Wallowa Mountains in northeastern Oregon. Geologists have had difficulty in mapping the OWL on the ground, even though a straight-line feature can be observed from space (Fig. 6-22). However, geology students from Whitman College at Walla Walla found evidence that a branch of this structure may cut deposits only a few thousand years old. The Wallula Fault Zone cutting the Columbia River Basalts near Milton-Freewater could be part of the OWL (Figure 6-21), and one branch, the Umapine Fault, may have evidence of Holocene activity.

The southeast end of the OWL is the linear northeast

range front of the high Wallowa Mountains, Oregon's version of the Swiss Alps, although glacial moraines 140,000 years old do not appear to be cut by a range-front fault. Other faults mark the boundaries of basins within the Blue Mountains, including Grande Ronde Valley containing the city of La Grande, and Baker Valley containing Baker City (Figure 6-20). The Baker Valley Fault at the base of the Elkhorn Mountains has evidence of Late Quaternary (although not Holocene) displacement. The West Grande Ronde and East Grande Ronde faults also have evidence of Late Quaternary movement. Both faults are expressed in tectonic topography. Farther southeast, other faults coincide with a zone of high seismicity near the Snake River in both Oregon and Idaho.

## **9. The Pasco Basin: Nuclear Wastes and Earthquakes**

The military aircraft droned over the bleak December landscape of eastern Washington, and its lone passenger took note of what he saw through the window. As he gazed down at the sagebrush-covered Hanford Reach, with the broad ribbon of the Columbia River curving away in the distance, Lt. Col. Franklin Matthias knew that he had the site he wanted: raw desert, virtually unpopulated, but with a dependable

water source, the Columbia River, close at hand (Figure 6-22). The nearest large city, Spokane, was nearly one hundred and twenty miles away. Matthias would report back to his superior, General Leslie Groves, military overseer for the top-secret Manhattan Project, that Hanford was suitable for a large super-secret government operation related to the war effort. The year was 1942.

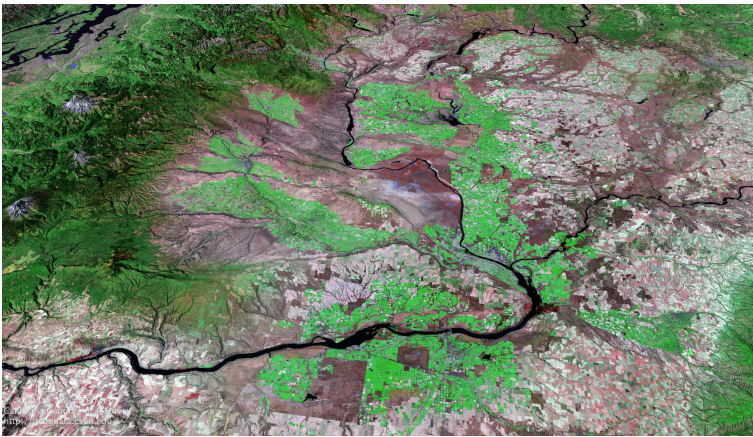

*Fig. 6-22. Oblique digital image of Yakima fold belt, view north. Image courtesy of William Bowen, California State University Northridge and California Geographical Survey. Columbia River doubles back on itself at Wallula Gap and flows west toward Portland. Linear features are Yakima folds. Farther west are three Cascade volcanoes and in upper left corner, the waters of Puget Sound. Compare with top map of Figure 6-21, which identifies major Yakima folds.*

Soon after, in 1943, the few Indians and farmers who had been scratching out a living in the Hanford Reach



were hustled out, and the government took over for a crash project to manufacture plutonium for an atomic bomb, the first of which would be dropped two years later on Nagasaki, Japan, bringing an end to World War II. Then came the Cold War, and Hanford continued to expand, still in secrecy, bringing jobs and prosperity to the Pasco Basin and the Tri-Cities of Richland, Pasco, and Kennewick. In addition to manufacturing plutonium, atomic reactors produced energy for the Bonneville power grid, and nuclear wastes began to be stored on the Hanford Reach.

In the 1980s, the site was proposed as a national nuclear waste dump, the Basalt Waste Isolation Project. By this time, though, serious reservations had been expressed about nuclear waste disposal in general and the Hanford site in particular. The Hanford N Reactor and the plutonium manufacturing facilities were shut down, and later, the proposed waste disposal site was shifted to Yucca Mountain in Nevada.

But still the legacy of nuclear wastes already stored at Hanford hangs over the Tri-Cities, and so it is useful now to look at the geologic setting and consider Hanford's hazard from earthquakes. Clearly, geology and earthquakes were not considered at all in Col. Matthias's report to General Groves. Now, however, a nuclear reactor is considered to be a *critical facility*, meaning that it is necessary to conduct exhaustive site studies to determine its long-term stability to hazards, even those that might be very unlikely, including earthquakes. Are the reactors and the plutonium

manufacturing plants able to withstand earthquake shaking? Would highly toxic radioactive waste stored in subterranean tunnels leak out following a major earthquake? To answer these questions, we look for evidence for past earthquakes in the geology around the site, especially in the long ridges of basalt known as the Yakima Folds (Figure 6-23).

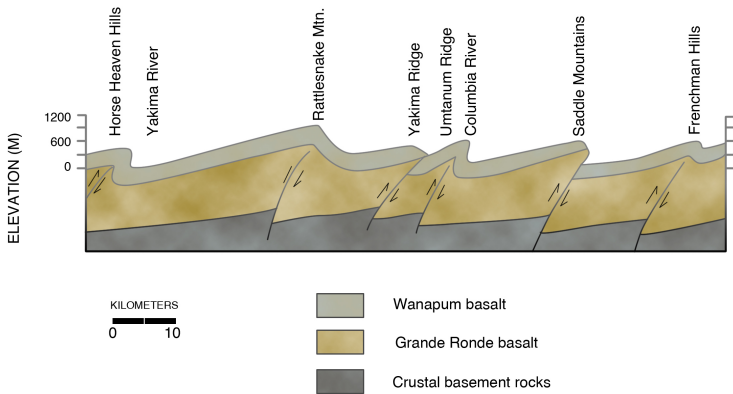

Figure 6-23. Geologic cross section across Yakima Fold Belt west of Hanford Reservation. Folds in basalt are interpreted as being forced up by compressional faults in rigid crust beneath the basalt; these faults may be earthquake sources. South is to the left.

Between Wenatchee and Hanford, the Columbia River turns southeast through a sagebrush-covered black-rock wasteland, away from the ocean, to cut a succession of gorges through basalt ridges on its way to the last canyon, Wallula Gap, where it turns sharply back on itself and heads west to Portland (Figures 6-21,

6-22). These basalt ridges, Frenchman Hills, Saddle Mountain, and Rattlesnake Mountain, are anticlinal folds in the Columbia River Basalt, crumpled like a heavy carpet after a sofa has been pushed over it (Figure 6-23). The Columbia has eroded through these anticlines as they formed. The anticlines are best seen in the canyon of the Yakima River between the towns of Ellensburg and Yakima—not from Interstate 82, which soars high over the gorge, but on lonely State Highway 821, which twists along the banks of the Yakima as the river lazes across broad synclines and churns through anticlinal cliffs of basalt.

Project managers working at the Hanford Nuclear Reservation tended to downplay the role earthquakes may have had in forming these anticlinal ridges, perhaps from wishful thinking, perhaps because they did not want to answer questions they had not been asked. One theory was that the anticlines formed millions of years ago, during or soon after the eruption of basalt, and were no longer active or an earthquake risk.

In fairness to the geologists and managers at Hanford, anticlines were not considered as harbingers of earthquakes until 1983, when an earthquake of M 6.7 trashed the downtown section of Coalinga, California, a small town on the west side of the San Joaquin Valley. There was no active fault at the surface at Coalinga, but the forces accompanying the earthquake were shown to add to the folding of an anticline at the surface. The implication of active folding is that the fold is underlain

by a *blind reverse fault* or *blind thrust*, one that does not reach the surface, but tends to force one block over another: faulting at depth, but only bending at the surface (Figure 3-10b). The 1994 Northridge California, Earthquake was caused by rupture on a blind thrust.

I once saw a Volkswagen bus that had been in a highway accident. There had been a carpet on the floor, as if its owner had been camping inside the bus. During the wreck, the flooring was buckled and broken, but the carpet was still continuous over the flooring, although it had a large hump in it over the break in the flooring. I thought about that VW bus as I studied the Northridge Earthquake—the bump in the carpet was the anticline, giving a silent clue to the unseen fault beneath. The same analogy could be made for the basalt ridges in the Pasco Basin.

Two college teachers, Bob Bentley of Central Washington University in Ellensburg and Newell Campbell of Yakima Valley College, trudged into Yakama Indian territory to examine Toppenish Ridge, a narrow anticline south of the city of Yakima (left center, Figure 6-21, top). They found normal faults on the crest of the anticline and reverse faults on its north flank where the anticline had been thrust northward toward the plowed fields of the Yakima Valley. These structures are not the same age as the Columbia River Basalt; they are much younger, possibly still active. Similar evidence later showed that the east end of the Saddle Mountain Anticline, east of the Columbia and north of Hanford, is also active. As shown in Figure 6-23, the prominent

anticlines overlies and provide evidence for blind reverse faults beneath, faults that themselves could produce large earthquakes at the nuclear reservation.

The Olympia-Wallowa Lineament (OWL) traverses southeast across the Hanford Reach and across the Yakima folds. Although it is visible on satellite images and on computer-generated digital topographic maps (Figure 6-22), its earthquake significance is unclear.

In summary, as Hanford's nuclear operations change into environmental cleanup mode, and the Tri-Cities await their fate, an earthquake assessment seems long overdue. The Hanford installation is not the only critical facility in the Pasco Basin; there are also the Wanapum, Priest Rapids, and McNary dams on the Columbia River. Failure of one of these dams could cause a repeat of the catastrophic floods of the Pleistocene, although on a greatly reduced scale. Critical facilities will be considered in a later chapter.

## **10. Basin and Range: the Klamath Falls Earthquakes of 1993**

Vacations in their native Oregon were a tradition with Ken and Phyllis Campbell. They came at a time when they could avoid the hottest part of the summer at their home in Phoenix, Arizona. Their 1993 excursion had been a grand trip, visiting old high-school friends

and taking a cruise ship up the Inside Passage to Alaska. But it was getting late, and Phyllis was anxious to reach their destination, a bed and breakfast in Klamath Falls, a city where she had gone to first grade. Ken was already looking forward to getting back to Phoenix, where he was constructing a workshop to restore classic cars and build toys for his grandchildren. Driving south on U.S. Highway 97 toward Klamath Falls, Phyllis watched the deer along the side of the road.

As they approached Modoc Point, a steep cliff beside the road, it occurred to Phyllis that she wouldn't see any deer on the left side of the highway because the cliff came right down to the road, and there was no shoulder. Suddenly she saw a blinding flash of light, then another one, and she thought for an instant that it must have been transformers exploding from a power surge.

At that instant, there was a loud crack, and Phyllis heard Ken cry out, "No!" A fourteen-foot boulder smashed down onto their pickup, killing Ken instantly. The windshield collapsed inward, and the truck spun out of control. When the spinning stopped, Phyllis found that she could unhitch her seat belt, but not Ken's. Nothing worked: she couldn't get the electric windows to open or the electric locks on the door to work, even though the engine was racing. She tried to turn off the ignition, but the key came off in her hand. She knew that Ken had to be dead, but she did not know how to get out of the truck. Then there was a man at the window, and she was pulled to safety.

The deadly boulder and the breached highway barrier are shown in Figure 6-24.



*Figure 6-24. Boulder at Modoc Point, alongside U.S. Highway 97, that breached a roadside barrier and took the life of Ken Campbell during the September 20, 1993, Klamath Falls Earthquake. Boulder has been pushed back behind barrier.*



*Figure 6-25. Downtown Klamath Falls, Oregon, after the earthquakes of September 20, 1993. Automobile parked in front of Swan's Bakery was crushed by falling bricks from an unreinforced parapet.*

At 8:28 p.m., September 20, 1993, Ken Campbell had become the first fatality caused by an earthquake in Oregon. An eighty-two-year-old woman, Anna Marion Horton of Chiloquin, died of a heart attack because she was frightened by the violent shaking of her house. At the Classico Italian restaurant in downtown Klamath Falls, bricks fell and blocked the sidewalk, and diners left their pasta uneaten and fled the building.

More than a thousand buildings were damaged (Figure 6-25), with a total loss of more than \$7.5 million. The Klamath County Courthouse, built in 1924, and the Courthouse Addition suffered damage of more than \$3 million. Unreinforced masonry buildings suffered the worst; well-built wood-frame houses that were bolted to their foundations fared relatively well.

There had been a warning twelve minutes before: a foreshock of magnitude 3.9. However, this part of Oregon was poorly covered by the existing network of seismographs, and there was no system in place to



evaluate the foreshock and issue a warning. Then, more than two hours after the first shock of magnitude 5.9, an even larger earthquake of magnitude 6 struck the region. The depth of the earthquakes was about six miles, much shallower than the Scotts Mills Earthquake. They were located west of Upper Klamath Lake beneath the Mountain Lakes Wilderness, between fifteen and twenty miles west-northwest of Klamath Falls (Figure 6-26). Starting in early December, a new swarm of earthquakes began east of the first group, close to the western shore of the lake, closer to Klamath Falls (Figure 6-26). After the first of the year, the aftershocks slowly began to die away.

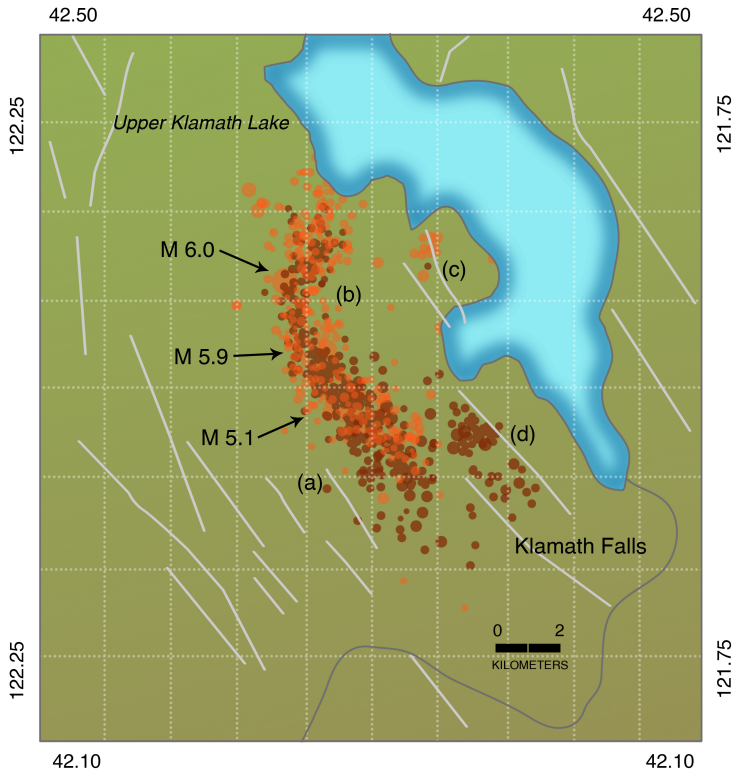

Figure 6-26. Earthquakes and aftershocks of the Klamath Falls earthquake sequence, September-December, 1993. Size of circles proportional to magnitude with the largest M 6.0. Open circles show earthquakes from September 20 to the time of an aftershock of M 5.1 on December 4. Solid circles show aftershocks from December 4 to 16. Second sequence is closer to Klamath Falls but is still west of Upper Klamath Lake. Note the absence of earthquakes in the city of Klamath Falls itself. Thin solid lines are faults; note that faults east of lake did not have earthquakes in 1993. From USGS

Unlike the country west of the Cascades, the stark,

arid landscape of southeastern Oregon leaves little of its geology to the imagination. Dave Sherrod of the USGS had been mapping the faults of the Klamath Falls region for several years, and early in 1993, before the earthquake, he had met with Klamath Falls officials to discuss the hazard.



A video element has been excluded from this version of the text. You can watch it online here:

<https://open.oregonstate.edu/earthquakes/?p=143>

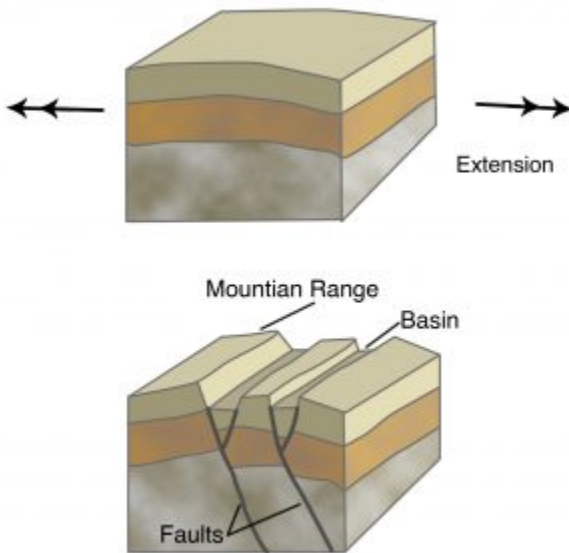

Figure 6-27. Structure of the Basin and Range Province of southeastern Oregon. Because the crust is extending east-west, normal faults form. The basin formed between two opposing normal faults is called a graben. Upper Klamath Lake (Figure 6-20) occupies a graben.

---

The basin containing Upper Klamath Lake and Klamath

Falls is a *graben*, downdropped between faults that dip downward toward and beneath the lake. These are called *normal faults*, and they result when the crust is pulled apart (Figures 3-10a, 6-27). Modoc Point, where Ken Campbell met his death, is part of a fault block. Over hundreds of thousands of years, the countryside east of Highway 97 has been uplifted, and the lowland to the west downdropped along west-dipping faults, so that it now lies beneath the lake. Farther south, other normal faults extend through the main part of Klamath Falls.

West of Upper Klamath Lake are other less prominent normal faults at the west edge of Howard Bay, in the Mountain Lakes Wilderness, and extending beneath Lake of the Woods (Figure 6-26). These faults, which dip east, were activated by the 1993 earthquakes, although there is no evidence that any of them ruptured all the way to the surface.

Fortunately for Klamath Falls, the faults on the *west* side of the graben ruptured rather than the faults on the *east* side, which extend directly through the city. If the east side faults had ruptured with earthquakes of comparable magnitudes, the damage to Klamath Falls, with its unreinforced masonry buildings, would have been disastrous, resulting in many deaths.

Eastward from the Cascades from Bend and Klamath Falls to the Owyhee River country stretch the block-fault mountains and the dry-lake grabens that make up the Oregon Basin and Range: Green Ridge and Walker Rim, Summer Lake and Winter Ridge, Lake Abert and

Abert Rim, and finally, higher than all the rest, and with evidence of Pleistocene glaciers, Steens Mountain, followed by the Alvord Desert (Figure 6-28).



*Figure 6-28. Steens Mountain in southeastern Oregon. An active fault with evidence for Holocene displacement is found at the base of Steens Mountain, separating it from the Alvord Desert in the foreground. Steens Mountain has been uplifted along the normal fault at its base accompanied by earthquakes over several million years. Photo by Robert Yeats*

Mark Hemphill-Haley, then with Woodward-Clyde Consultants, found a fault at the foot of the Steens, snaking along the west edge of the Alvord Desert Graben. The Steens Mountain Fault shows geological evidence of a Holocene earthquake within the last ten thousand years, based on trench excavations. Hemphill-Haley could then conclude on the basis of

geologic evidence alone that the fault at the foot of the Steens is *active* in the legal sense of the word, which means that special precautions should be taken to guard any major structures against seismic shaking. Fortunately, there are only a few ranches and herds of livestock, and they would probably survive a magnitude 7 quake without much problem.

Hemphill-Haley had the answer to why Steens Mountain is there in the first place. It has been gradually raised up from the desert floor along its range-front fault, accompanied by literally thousands of earthquakes over a period of millions of years, each earthquake lifting the mountain up just a few feet. The cumulative effect of all these individual uplifts is the massive, rugged fault-block mountain we see today, snow capped much of the year, towering over the playa flats of the Alvord Desert to the east (Figure 6-28).

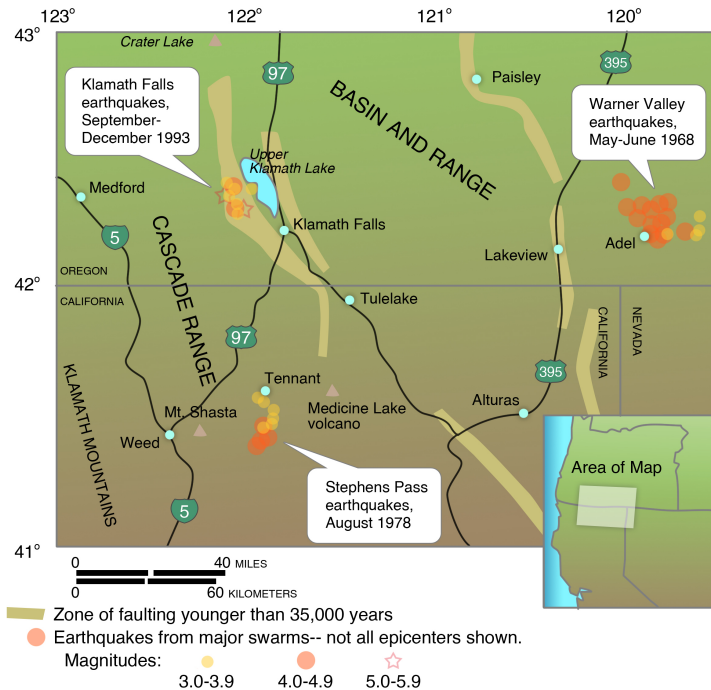

Figure 6-29. Map showing locations of recent earthquake swarms in southern Oregon and northern California, including the Warner Valley, Oregon, earthquakes of 1968. From USGS.

West of Steens Mountain, a swarm of earthquakes struck the small town of Adel, in Warner Valley, in 1968, with the largest of magnitude 5.1 (Figure 6-29). Silvio Pezzopane and Ray Weldon of the University of Oregon found other active faults in the desert west of Abert Rim, and they applied the new science of paleoseismology to find evidence of prehistoric earthquakes in backhoe trenches across fault scarps.



Faults that are active on the basis of offset Holocene deposits were found in Paulina Marsh, at the west edge of Summer Lake near Winter Rim, and along the west boundary of Abert Rim. Normal faults in eastern Oregon are seen on computer-generated topographic images, including faults in and near Bend, Oregon (Figure 6-30). (The Bend fault scarps may be active, but faulting involves sediments in part derived from Cascade volcanoes to the west, and they might be due to resistance to erosion of volcanic-derived sediments rather than Holocene faulting.)

The Oregon Basin and Range is the northern continuation of the Basin and Range of Nevada (Figure 6-31), including the Central Nevada Seismic Zone, which was rocked repeatedly by a series of eight earthquakes, starting in 1903 and ending in 1954, the largest of magnitude 7.5. Fault scarps that formed during several of these earthquakes are magnificently preserved in the desert climate (Figure 3-7) and can be seen by driving a back road south of Winnemucca, Nevada, through Pleasant Valley at the western foot of the Sonoma and Tobin ranges, over the Sou Hills, down Dixie Valley east of the Stillwater Range, to U.S. Highway 50, itself broken by a surface rupture



Figure 6-30. Computer-generated topographic map of Bend, Oregon, region showing young faults (linear features marked F). Image is illuminated by a light source from northeast that is 15 degrees above the horizon; accordingly, fault scarps that face northeast are brightly lit, whereas fault scarps facing southwest (such as the lineation marked F? north of Pilot Butte) are in shadow. These faults cut volcanic materials and sediments as young as late Pleistocene, but are not known to cut Holocene deposits. The prominence of these faults may be due to the greater consolidation of the deposits cut by them rather than their Holocene age. The fault scarp in

accompanying an earthquake of magnitude 7.2 on December 16, 1954. Like the Steens country, the Central Nevada

*Bend may be seen on Bend city streets. Pilot Butte and Aubrey Butte are volcanoes. Image created by Rose Wallick, Oregon State University*

Seismic Zone is thinly populated, and although the earthquakes were felt over large areas, the losses were small.

Despite the intense seismic activity in this century, long-term slip rates on faults in the Central Nevada Seismic Zone are extremely slow, comparable to slip rates on faults in the Oregon Basin and Range. Paleoseismology shows that prior to the twentieth century, earthquakes occurred many thousands of years ago. We refer to the Nevada earthquakes of the twentieth century as an *earthquake cluster*, characterized by intense activity over a short period of time separated by thousands of years of quiet. The Oregon Basin and Range is similar to the Central Nevada Seismic Zone, but its seismic silence shows that it is in a quiet period. We know that this quiet period will end someday, but we do not know when—tomorrow or thousands of years from now. Sadly, forecasts made in terms of many thousands of years do not answer the societal questions about timing (next year or fifty years from now?) that are of interest to you and me and those around us.

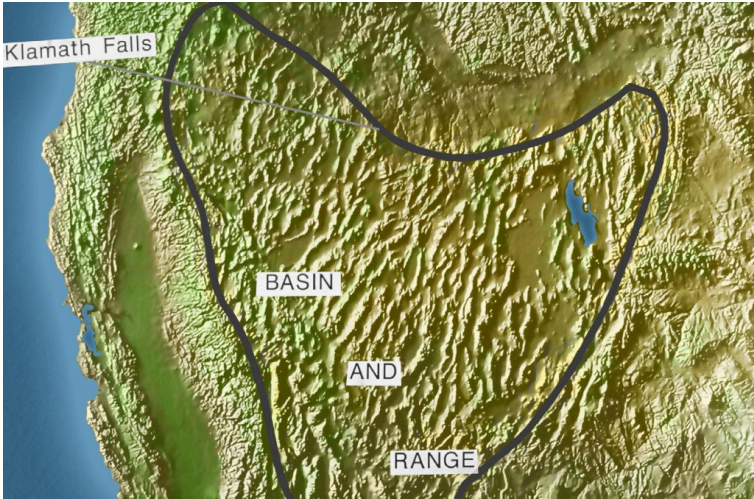

Figure 6-31. A Computer-generated topographic map of the Basin and Range Province. The linear pattern is formed by block-fault mountain ranges bound by normal faults and separated by valleys and grabens. From USGS.

## II. Pacific Coast and Offshore

The Northwest coastline is struck on occasion by winter storms of great ferocity, among the most violent in the world. The ocean waves that crash against the rocky headlands and from time to time across Highway 101 are agents of geologic change. They grind down rocky platforms and tide pools and eat into the base of the sea cliffs, occasionally causing beachfront homes and condos built on top of the cliffs to topple into the sea. The boundary between the rocky platform and the

sea cliff is called the *shoreline angle* (Figure 6-32), and it is formed at sea level.



*Figure 6-32. View south from Cape Foulweather along the central Oregon coast. The Inn at Otter Crest is in foreground, and Otter Rock village and Devil's Punchbowl are behind. Within the surf are outcrops of basalt that have been planed off by wave erosion to a flat platform. The angle between the eroded platform and the beach cliff is called the shoreline angle and is at sea level. The Inn at Otter Crest and Otter Rock are built on an older marine erosion platform that may be eighty thousand years old (note horizontal layer in sea cliff). It, too, has a shoreline angle marking sea level in late Pleistocene time. Photo by Alan Niem, Oregon State University*

Highway 101 and many of the resort cities and fishing villages of the coast rest on older, higher sand-covered marine platforms that were eroded during the late Pleistocene. A marine platform 125,000 years old marks a time when sea level was as much as twenty feet higher

than it is today. At places like Cape Arago, Oregon, several of these platforms of different ages lie at different elevations, like giant stair steps, the oldest more than two hundred thousand years old. The shoreline angles of these old marine platforms indicate the position of ancient Pleistocene sea levels. Careful surveying by Harvey Kelsey of Humboldt State University in Arcata, California, and his colleagues and students shows that these shoreline angles are not horizontal, like the modern one is, but they rise and fall, and in some places are cut by faults (Figures 6-33). Because the shoreline angles reflect ancient sea levels, meaning that they were once horizontal, their deformation allowed Kelsey to measure tectonic crustal deformation along the Pacific coast.

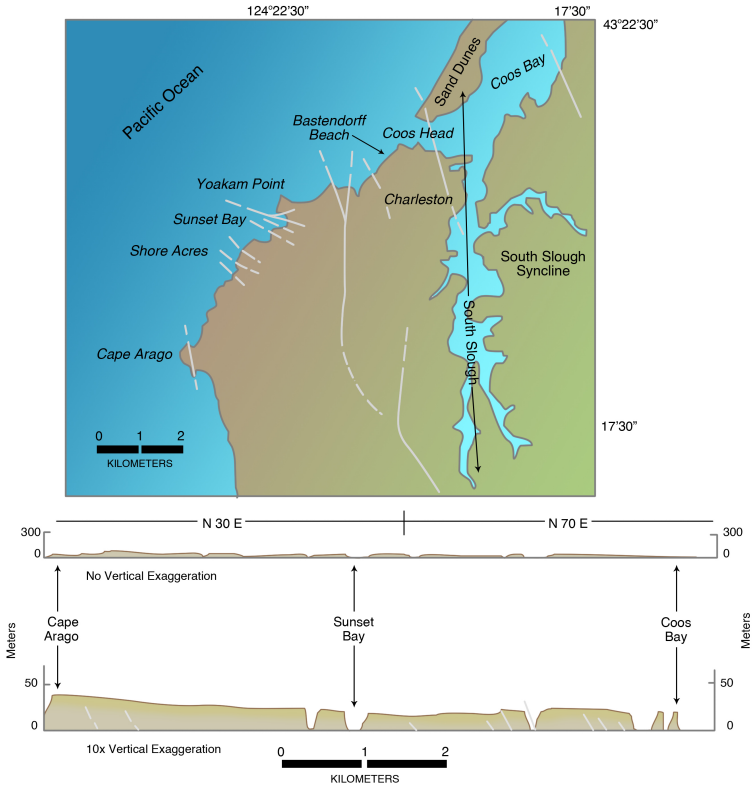

Figure 6-33. (Top) Map of Cape Arago-Coos Bay region, southwest Oregon, showing marine terrace platforms and active faults. (Bottom) Cross section along the coast from Cape Arago to Coos Bay showing tilting and faulting of Whiskey Run marine terrace and platform, eighty thousand years old. One cross section shows the vertical scale exaggerated ten times the horizontal scale, the other shows the cross section without vertical exaggeration. From G. McNelly and H. Kelsey, Humboldt State University

The seismicity of the coastal regions north of California is relatively low, and there is no direct evidence that the

formerly horizontal shoreline angles were deformed by earthquakes. Deformed marine terraces have been described by Lisa McNeill of Oregon State University (now at Southampton University in England) and Pat McCrory of the USGS. McNeill found that some of the downwarps along the coast, such as South Slough near Coos Bay, Oregon, and the mouth of the Queets River in Washington, correspond to active folds offshore, and these structural lows contain peat deposits that were downdropped suddenly by great earthquakes. Even Willapa Bay, the site of Atwater's discovery of buried marshes in Niawiakum Estuary, is the location of an active syncline offshore. Deformation along the Olympic coast mapped by McNeill and McCrory may be correlated to the north-south shortening of one-fourth inch per year recorded by GPS in the Puget Sound region.

In summary, the low seismicity may mean that deformation of these shoreline angles and downdropping of the structural depressions may be secondary crustal responses to past great earthquakes on the Cascadia Subduction Zone. Alternatively, they may be related to earthquakes in the crust that were not associated with movement on the subduction zone.

Offshore, on the continental shelf and slope, active deformation is more intense. The continental shelf itself, very broad off Washington, narrow off southern Oregon and northern California, was eroded to a flat surface during times of Pleistocene glacial advance, when great expanses of ice had taken up water that



otherwise would have returned to the sea. During these times of ice advance, sea level was almost four hundred feet lower than it is today, and the continental shelf was dry land.

Chris Goldfinger of Oregon State University wondered if the coastline at the time of maximum ice advance twenty-one thousand years ago, when sea level was four hundred feet lower, shows the same evidence of erosion as the modern coast does. To answer this question, he and I and our colleagues surveyed the edges of Nehalem Bank, Heceta Bank, and Coquille Bank on the Oregon continental shelf, using side-scan sonar and *Delta*, a two-person submersible. What we discovered was truly remarkable: another Oregon coast, drowned beneath the sea at the edge of the shelf, complete with rocky headlands, estuaries, and barrier-island sand bars (Figure 6-34). *Delta* cruised along this Pleistocene beach, now covered by soft mud, and we observed holes at the base of the cliff rather like the holes made by organisms at the base of modern sea cliffs. The rise of sea level approximately fourteen thousand years ago had been so rapid, more than an inch per year, that these shoreline features were preserved, like the wreck of the *Titanic*, rather than being destroyed by wave erosion.

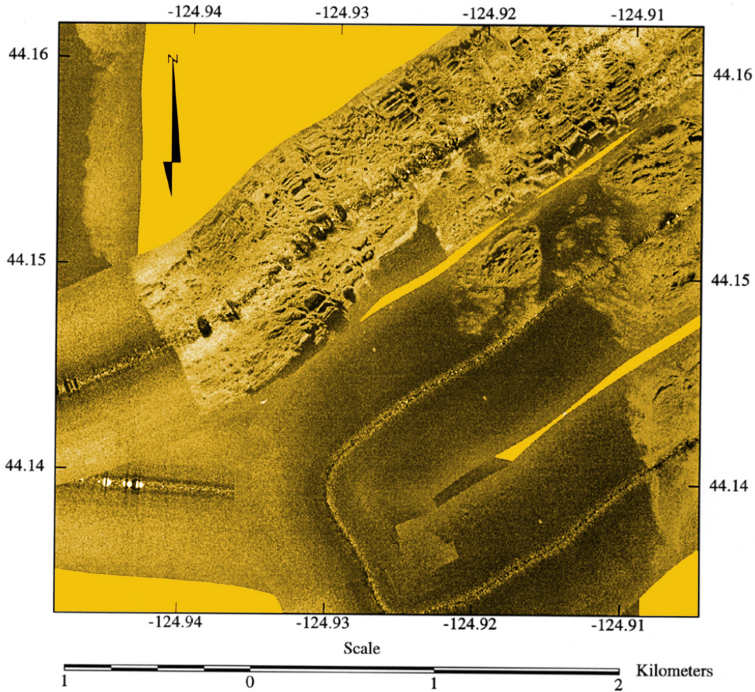

Figure 6-34. The other Oregon coast. Sidescan sonar imagery outlines a shoreline angle developed at the maximum Pleistocene ice advance twenty-one thousand years ago on the west side of Heceta Bank west of Florence, now covered with four hundred feet of sea water. Visible are rocky cliffs (like the present coastline north of Otter Rock) and the mouth of a Pleistocene river. Some of the rocks at the base of the cliffs have been bored in shallow water by marine organisms. The dark gray region in the lower left half of the picture is the former marine erosion platform, now covered with Holocene mud. The Heceta Bank shoreline angle is warped and deformed, evidence of deformation of the Oregon continental shelf.

But unlike the present shoreline angle, which is at sea level and is horizontal, these shoreline angles rise and

fall, like the shoreline angles of the raised Pleistocene beaches along the coast. The continental shelf had been warped and tilted, possibly during earthquakes.

One of our most memorable discoveries was during our survey of Stonewall Bank southwest of Newport, Oregon, an area known to local commercial fishers as “the rock pile.” Our side-scan sonar imagery showed that Stonewall Bank is a rocky ridge split by a broad former river channel, the seaward extension of the Yaquina River when sea level was lower than it is today (Figure 6-35). Surprisingly, the river channel now slopes about twenty-five feet *eastward* toward Newport. Since water originally must have run downhill toward the west, we concluded that the river channel was tilted back toward its source during the last twelve thousand years. We had discovered the eastern flank of a broad anticline beneath Stonewall Bank, an anticline formed by a blind reverse fault like the fault that ruptured during the Northridge Earthquake and the faults that may underlie the folded basalt ridges of the Pasco Basin (Figure 6-23).

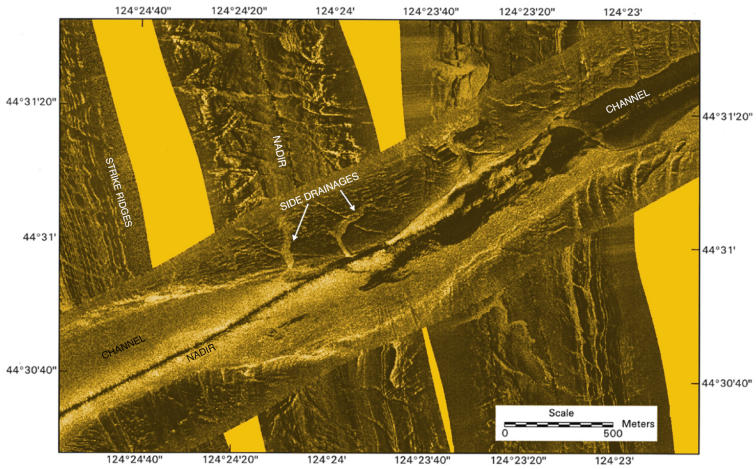

Figure 6-35. Sidescan sonar image of a river channel crossing Stonewall Bank, southwest of Newport, now covered with two hundred feet of sea water. The channel, marking the seaward continuation of the Yaquina River, is now tilted eastward, evidence of deformation of the Oregon continental shelf in the last twelve thousand years. Image courtesy of Chris Goldfinger, College of Oceanic and Atmospheric Sciences, Oregon State University; see also Yeats et al. (1998)

The three sources of northern California earthquakes—the subduction zone, Gorda Plate, and the crust—are so interconnected that it is difficult to isolate faults and earthquakes that are limited to North American continental crust. Where the Cascadia Subduction Zone turns to the southeast near the Mendocino Fracture Zone, it is not a single fault but a zone, fifty to sixty miles wide (Figure 5-2), of thrust faults and warped marine terraces in addition to the

buried fault that ruptured in the 1992 Cape Mendocino Earthquake.

Although many crustal faults in this region may have some Holocene displacement, two zones are the most active: the Mad River Fault Zone between Trinidad and Arcata, which includes the Mad River and McKinleyville faults, and the Little Salmon Fault south of Eureka (Figure 4-22). These structures account for about a third of an inch of shortening per year, which is about 20-25 percent of the convergence rate between the Gorda and North America plates. Backhoe trench excavations by Gary Carver of Humboldt State University across these fault zones (Figure 6-36) provide paleoseismologic evidence that the last two earthquakes on the McKinleyville Fault and Mad River Fault produced displacement of at least eight feet for each event, evidence that these earthquakes were greater than M 7. Trench excavations across the Little Salmon River Fault reveal evidence for three earthquakes in the last seventeen hundred years, each with displacements of eight to ten feet. The last earthquake struck about three hundred years ago. The late Holocene slip rate on the Little Salmon River Fault alone is one-fifth inch (three to seven millimeters) per year.

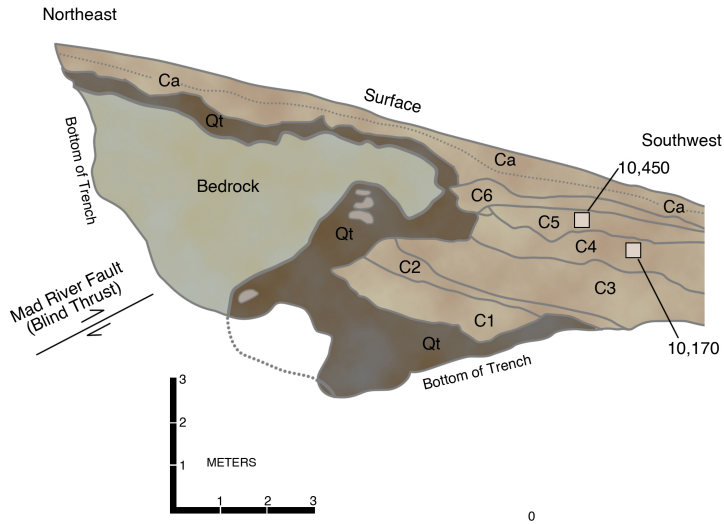

Figure 6-36. Log of side of backhoe trench across a scarp of the Mad River Thrust Fault at McKinleyville, California, showing how bedrock has been thrust over sediments that are radiocarbon dated at about ten thousand years. Laboratory errors are  $\pm 60-80$  years. The bedrock is overlain by a wave-cut platform which is itself overlain by terrace deposits (Qt). These were folded, indicating that the Mad River Fault is a blind thrust at this locality. The terrace deposits are overlain by debris from the rising fault scarp (C1 through C6); each unit may have been deposited during an earthquake. Ca marks the active slope wash and debris. Modified from a sketch by Gary Carver, Humboldt State University

At Clam Beach, near the McKinleyville Fault, Carver found an uplifted beach cliff and tide-pool platform carved by waves from an ancient sea. The beach sand resting on this platform contains a driftwood log that is one thousand to twelve hundred years old, based

on radiocarbon dating. Another beach sand deposit overlies the driftwood log. This sand was colonized by beach grass and a coastal forest. A dead tree in this forest, still rooted in a soil on top of the beach deposit, is no more than three hundred years old. This tree and its soil are overlain by still another beach deposit, perhaps recording subsidence related to movement on the McKinleyville Fault at the time of the A.D. 1700 Cascadia Subduction Zone Earthquake.

Between these two fault zones are Arcata Bay and Humboldt Bay, where subsided marshes have been found (Figure 4-12). At first, it was thought that the marsh subsidence was related to rebound from a subduction-zone earthquake, like marshes in Oregon and Washington and in marshes downdropped during the 1964 Alaska Earthquake (Figure 4-15). But this area is so close to the subduction zone that the coast would have been uplifted during an earthquake, just as islands close to the Alaska subduction zone were uplifted in 1964 (Figure 4-15). In addition, the coastline was uplifted in the 1992 Cape Mendocino Earthquake on the subduction zone. The bay was downwarped due to crustal deformation, especially slip on the Little Salmon Fault. Because the age of the drowned marsh is three hundred years, like the age of the youngest subsided marshes in Oregon and Washington, the crustal deformation probably occurred at the same time as the most recent subduction-zone earthquake.

Uplifted marine terraces cut by storm waves provide additional evidence of crustal deformation. If there

were no crustal deformation, the older, uplifted marine terraces would be completely level, like the present marine platform is. But the older terraces are tilted and warped, as is evident by viewing the coast north from Patricks Point State Park. This provides evidence that the Earth's crust in this region is on the move, up and down, through folding and faulting, producing earthquakes in the process.

An earthquake of M 6.4 on June 6, 1932, near Arcata produced intensity as high as VIII, resulting in one death and considerable damage in Eureka. On December 21, 1954, an earthquake of M 6.5-6.6 struck twelve miles east of Arcata in the vicinity of the McKinleyville Fault Zone, causing one death and \$3.1 million in damage. And on August 17, 1991, a M 6.2 earthquake struck at seven miles depth beneath the community of Honeydew on the Mattole River. The official estimate of damage in this relatively unpopulated region was fifty thousand dollars, but this estimate is probably low. Intensities of VII and VIII were encountered, as they were in the two earlier crustal earthquakes.



It is clear that for their size, the crustal earthquakes were more damaging than Gorda Plate earthquakes. They struck at shallow depth close to population centers, whereas most of the Gorda Plate earthquakes were offshore, some so far offshore that onshore damage was minimal.

Curiously, under a new California insurance plan discussed in Chapter 10, the Eureka region will be charged earthquake insurance rates that are among California's lowest, despite accounting for a quarter of the state's seismicity!

This chapter closes with an image from the submersible DELTA of a fault scarp at a depth greater than 750 feet, too deep for active wave action (Figure 6-37). This fault could have been formed during a crustal earthquake, or it could have been the result of a secondary fault related to a subduction-zone earthquake. The answer to this question is not yet at hand.



*Fig. 6-37. Active fault scarp on continental shelf west of Newport, Oregon, photographed from submersible DELTA. The scarp is too deep to be affected by active wave action. Two light dots are 20 cm apart. Photo by Gary Huftile, then of OSU.*

## 12. Summary

In estimating the seismic hazard from crustal earthquakes, we study three lines of evidence: geology, seismology, and geodetic evidence using GPS. In the Puget Sound region, we have all three: Holocene active faults and folds, high instrumental seismicity, and GPS evidence of shortening. In northern California, we also have geological and seismological evidence of earthquake hazard, including damaging historical earthquakes that have caused fatalities. The two Oregon earthquakes come close: the Scotts Mills earthquake probably took place on the Mt. Angel fault, and the Klamath Falls earthquakes were the result of motion on normal faults bounding the Klamath Falls graben.

In other places, the evidence is less complete. The largest crustal earthquakes in the Pacific Northwest on Vancouver Island and near Entiat in northern Washington took place in areas with little or no geological evidence of young faulting. The active Portland Hills Fault is in an area of moderate seismicity, but many of the earthquakes around Portland cannot be correlated to that fault. The Milton-Freewater Earthquake was not assigned to a specific fault, but it may be part of an active fault system following the Olympic-Wallowa Lineament (OWL).

Some areas have geological evidence for young faulting, but have not experienced large earthquakes.

These areas include the Oregon Basin and Range east and north of Klamath Falls and the folded basalt ridges of the Pasco Basin in Washington. The faults around La Grande and Baker City, Oregon, show geological evidence of activity, but they have not been the source of large earthquakes. The southeastern end of the OWL has moderate seismicity, but as yet, this area has not been damaged by a large earthquake.

What about the rest of the Northwest? The Oregon Coast Range and the Klamath-Siskiyou regions of Oregon have no clear evidence of active faulting and also have very few earthquakes. Similarly, the Coast Mountains of British Columbia, the Columbia Plateau of Washington, and much of the Blue Mountains of Oregon have low seismicity and little evidence of active faulting. At present, these areas are placed in a lower-risk category, but the next earthquake could prove this assessment wrong.

---

### *Suggestions for Further Reading*

Allen, J. E., M. Burns, and S. C. Sargent. 1986. *Cataclysms on the Columbia*. Portland, Timber Press, 211 p.

Atwater, B. F., and A. L. Moore. A tsunami about 1000 years ago in Puget Sound, Washington. *Science*, v. 258, p. 1614-17.

Bakun, W. H., R. A. Haugerud, M. G. Hopper, and R. S.

- Ludwin., 2002. The December 1872 Washington State earthquake. *Bulletin of the Seismological Society of America*, v. 92, p. 3239-58.
- Blakely, R. J., R. E. Wells, T. L. Tolan, M. H. Beeson, A.M. Tréhu, and L. M. Liberty. 2000. New aeromagnetic data reveal large strike-slip faults in the northern Willamette Valley, Oregon. *Geological Society of America Bulletin*, v. 112, p. 1225-33.
- Blakely, R. J., R. E. Wells, C. S. Weaver, and S. Y. Johnson. 2002. Location, structure, and seismicity of the Seattle fault zone, Washington: Evidence from aeromagnetic anomalies, geologic mapping, and seismic reflection data. *Geological Society of America Bulletin*, v. 114, p. 169-77.
- Bott, J. D. J., and I. G. Wong. 1993. Historical earthquakes in and around Portland, Oregon. *Oregon Geology*, v. 55, no. 6, p. 116-22.
- Bourgeois, J., and S. Y. Johnson. 2001. Geologic evidence of earthquakes at the Snohomish Delta, Washington, in the past 1200 yr: *Geological Society of America Bulletin*, v. 113, p. 482-94.
- Brocher, T. M., T. Parsons, R. J. Blakely, N. I. Christensen, M. A. Fisher, R. E. Wells, and the SHIPS Working Group. 2001. Upper crustal structure in Puget Lowland, Washington: Results from the 1998 Seismic Hazards Investigations in Puget Sound. *Journal of Geophysical Research*, v. 106, p. 13,541-13,564.
- Bucknam, R. C., E. Hemphill-Haley, and E. B. Leopold. 1992. Abrupt uplift within the past 1700 years at

- southern Puget Sound, Washington. *Science*, v. 256, p. 1611-14.
- Campbell, N. P., and R. D. Bentley., 1981. Late Quaternary deformation of the Toppenish Ridge uplift in south-central Washington. *Geology*, v. 9, p. 519-24.
- Cassidy, J. F., R. M. Ellis, and G. C. Rogers. 1988. The 1918 and 1957 Vancouver Island earthquakes. *Bulletin of the Seismological Society of America*, v. 78, p. 617-35.
- Clarke, S. H., and G. A. Carver. 1992. Late Holocene tectonics and paleoseismicity, southern Cascadia subduction zone. *Science*, v. 255, p. 188-92.
- D'Antonio, M. 1993. *Atomic harvest: Hanford and the lethal toll of America's nuclear arsenal*. New York: Crown Publishers, 304 p.
- Dehlinger, P., R. G. Bowen, E. F. Chiburis, and W. H. Westphal. 1963. Investigations of the earthquake of November 5, 1962, north of Portland. *The Ore Bin*, v. 25, no. 4, p. 53-68
- Dengler, L., G. Carver, and R. McPherson. 1992. Sources of North Coast seismicity. *California Geology*, v. 45, p. 40-53.
- Dengler, L., K. Moley, R. McPherson, M. Pasyanos, J. W. Dewey, and M. Murray. 1995. The September 1, 1994 Mendocino Fault earthquake. *California Geology*, v. 48, p. 43-53.
- Dragovich, J.D., J. E. Zollweg, A. L. Qamar, and D. K. Norman., 1997. The Macaulay Creek Thrust, the 1990 5.2-magnitude Deming Earthquake, and Quaternary geologic anomalies in the Deming area, western

- Whatcom County, Washington—Cause and effects? *Washington Geology*, v. 25, no. 2, p. 15-27.
- Geomatrix Consultants. 1995. Seismic design mapping, State of Oregon. Final report prepared for the Oregon Department of Transportation, Project 2442, Salem, OR.
- Gore, R., and J. Richardson. 1998. Cascadia: Living on Fire. *National Geographic*, v. 193, no. 5, p. 6-37.
- Gower, H. D., J. C. Yount, and R. S. Crosson. 1985. Seismotectonic map of the Puget Sound region, Washington. USGS Map I-1613, scale 1:250,000, booklet, 15 p.
- Haugerud, R. A., D. J. Harding, S. Y. Johnson, J. L. Harless, C. S. Weaver, and B. L. Sherrod. 2003. High-resolution lidar topography of the Puget Lowland, Washington. *GSA Today*, v. 13, no. 6, p. 4-10.
- Hemphill-Haley, M. A., W. D. Page, G. A. Carver, and R. M. Burke. 2000. Paleoseismology of the Alvord Fault, Steens Mountain, southeastern Oregon. *American Geophysical Union Reference Shelf* 4, p. 537-40.
- Humboldt Earthquake Information Center. How to survive earthquakes and tsunamis on the north coast. Humboldt State University, Arcata CA 95532-8299, 23 p. A simple guide to protection against earthquakes and tsunamis. Free. Web site: [http://sorrel.humboldt.edu/~geodept/earthquakes/eqk\\_info.html](http://sorrel.humboldt.edu/~geodept/earthquakes/eqk_info.html)
- Hyndman, R. D., S. Mazzotti, D. Weichert, and G. C. Rogers. 2003. Frequency of large crustal earthquakes in Puget Sound-southern Georgia Strait predicted

- from geodetic and geological deformation rates. *Journal of Geophysical Research*, v. 108, doi:10.1029/2001JB001710.
- Hyndman, R. D., G. C. Rogers, H. Dragert, K. Wang, J. J. Clague, J. Adams, and P. T. Bobrowski. 1996. Giant earthquakes beneath Canada's west coast. *Geoscience Canada*, v. 23, no. 2, p. 63-72.
- Jacoby, G. C., P. L. Williams, and B. M. Buckley. 1992. Tree ring correlation between prehistoric landslides and abrupt tectonic events in Seattle, Washington. *Science*, v. 258, p. 1621-23.
- Johnson, S. Y., C. J. Potter, J. M. Armentrout, J. J. Miller, C. Finn, and C. S. Weaver. 1996. The southern Whidbey Island fault: An active structure in the Puget Lowland, Washington. *Geological Society of America Bulletin*, v. 108, p. 334-354.
- Johnson, S. Y., S. V. Dadisman, J. R. Childs, and W. D. Stanley. 1999. Active tectonics of the Seattle fault and central Puget Sound, Washington: Implications for earthquake hazards. *Geological Society of America Bulletin*, v. 111, p. 1042-1053.
- Karlin, R. E., and S. E. B. Abella. 1992. Paleoearthquakes in the Puget Sound region recorded in sediments from Lake Washington, U.S.A. *Science*, v. 258, p. 1617-20.
- Kelsey, H. M., and G. A. Carver. 1988. Late Neogene and Quaternary tectonics associated with northward growth of the San Andreas transform fault, northern California. *Journal of Geophysical Research*, v. 93, p. 4797-19.

- Komar, P. D. 1997. *The Pacific Northwest Coast: Living with the Shores of Oregon and Washington*. Durham, N.C.: Duke University Press, 195 p.
- Liberty, L. M., M. A. Hemphill-Haley, and I. P. Madin. 2003. The Portland Hills Fault: Uncovering a hidden fault in Portland, Oregon, using high resolution geophysical methods. *Tectonophysics*, v. 368, p. 89-103.
- Logan, R. L., and T. J. Walsh. 1995. Evidence for a large prehistoric seismically induced landslide into Lake Sammamish. *Washington Geology*, v. 23, no. 4, p. 3-5.
- Logan, R. L., R. L. Schuster, P. T. Pringle, T. J. Walsh, and S. P. Palmer. 1998. Radiocarbon ages of probable coseismic features from the Olympic Peninsula and Lake Sammamish, Washington. *Washington Geology*, v. 16, no. 2/3, p. 59-67.
- Madin, I. P., and others. 1993. March 25, 1993, Scotts Mills earthquake—western Oregon’s wake-up call. *Oregon Geology*, v. 44, no. 3, p. 51-57.
- Madole, R. F., R. L. Schuster, and A. M. Sarna-Wojcicki. 1995. Ribbon Cliff landslide, Washington, and the earthquake of 14 December 1872. *Bulletin of the Seismological Society of America*, v. 85, p. 986-1002.
- Mann, G. M., and C. E. Meyer. 1993. Late Cenozoic structure and correlations to seismicity along the Olympic-Wallowa Lineament, northwest United States. *Geological Society of America Bulletin*, v. 105, p. 853-71.
- McCrary, P. A. 1996. Evaluation of fault hazards,



- northern coastal California. USGS Open-File Report 96-656, 87 p.
- McCrary, P. A., D. S. Foster, W. W. Danforth, and M. R. Hamer. 2002. Crustal deformation at the leading edge of the Oregon Coast Range block, offshore Washington (Columbia River to Hoh River). USGS Professional Paper 1661-A, 47 p.
- McNeill, L. C., C. Goldfinger, R. S. Yeats, and L. D. Kulm. 1998. The effects of upper plate deformation on records of prehistoric Cascadia subduction zone earthquakes. Geological Society, London Special Publication 146, p. 321-42.
- McPherson, R. C., and L. A. Dengler. 1992. The Honeydew Earthquake. California Geology, v. 45, p. 31-39.
- Nelson, A. R., S. Y. Johnson, H. M. Kelsey, R. E. Wells, B. L. Sherrod, S. K. Pezzopane, L.-A. Bradley, R. D. Koehler, III, and R. C. Bucknam. 2003. Late Holocene earthquakes on the Toe Jam Hill fault, Seattle fault zone, Bainbridge Island, Washington. Geological Society of America Bulletin, v. 115, p. 1388-1403.
- Oppenheimer, D., and others. 1993. The Cape Mendocino, California, earthquakes of April 1992: subduction at the triple junction. Science, v. 261, p. 433-38.
- Pezzopane, S., and R. Weldon. 1993. Tectonic role of active faulting in central Oregon. Tectonics, v. 12, p. 1140-69.
- Rogers, G. C. 1994. Earthquakes in the Vancouver area, in Monger, J. W. H., ed., Geology and geological

- hazards of the Vancouver region, southwestern British Columbia. Geological Survey of Canada Bulletin 481, p. 221-29.
- Schuster, R. L., R. L. Logan, and P. T. Pringle. 1992. Prehistoric rock avalanches in the Olympic Mountains, Washington. *Science*, v. 258, p. 1620-21.
- Stein, R. S., and R. S. Yeats. 1989. Hidden earthquakes. *Scientific American*, v. 260, no. 6, p. 48-57. (A discussion of blind faults and earthquakes.)
- U.S. Geodynamics Committee. 1994. Mount Rainier, Active Cascade Volcano. Washington, D.C.: National Academy Press, 114 p.
- Walsh, T. J., R. L. Logan, and K. G. Neal. 1997. The Canyon River fault, an active fault in the southern Olympic Range, Washington. *Washington Geology*, v. 25, no. 4, p. 21-24.
- Wiley, T. J., and others. 1993. Klamath Falls earthquakes, September 20, 1993—including the strongest quake ever measured in Oregon. *Oregon Geology*, v. 55, no. 6, p. 127-36.
- Wilson, J. R., M. J. Bartholomew, and R. J. Carson. 1979. Late Quaternary faults and their relationship to tectonism in the Olympic Peninsula, Washington. *Geology*, v. 7, p. 235-39.
- Wong, I. G., and J. D. J. Bott. 1995. A look back at Oregon's earthquake history, 1841-1994. *Oregon Geology*, v. 57, no. 6, p. 125-39.
- Wong, I. G., M. A. Hemphill-Haley, L. M. Liberty, and I. P. Madin. 2001. The Portland Hills Fault: An earthquake

generator or just another old fault? *Oregon Geology*, v. 63, p. 39-50.

Yeats, R.S., Graven, E.P., Werner, K.S., Goldfinger, C., and Popowski, T.A., 1996, *Tectonics of the Willamette Valley, Oregon*: U.S. Geol. Survey Prof. Paper 1560, p. 183-222, maps, 1:100,000.

Yeats, R. S., L. D. Kulm, C. Goldfinger, and L. C. McNeill. 1998. Stonewall anticline: An active fold on the Oregon continental shelf. *Geological Society of America Bulletin*, v. 110, p. 572-87.

# 7. Memories of the Future: The Uncertain Art of Earthquake Forecasting

*“What’s past is prologue.”*

William Shakespeare, *The Tempest*, Act II

*“Since my first attachment to seismology, I have had a horror of predictions and of predictors. Journalists and the general public rush to any suggestion of earthquake prediction like hogs toward a full trough.”*

Charles Richter, *Bulletin of the Seismological Society of America*, 1977

## I. A Mix of Science and Astrology

Predicting the future does not sit well with most earthquake scientists, including Charles Richter, quoted above. Yet if earthquake research is to truly

benefit society, it must lead ultimately to prediction, no matter how elusive that goal may be.

Society asks specialists to predict many things, not just earthquakes. How will the stock market perform? Will next year be a good crop year? Will peace be achieved in the Middle East? The answers to any of these important questions, including the chance of a damaging earthquake near you in the near future, depend on complex bits of information. For each question, experts are asked to predict outcomes, and their opinions often are in conflict. Mathematicians tell me that predicting earthquakes and predicting the behavior of the stock market have a lot in common, even though one is based on physical processes in the Earth, and the other is not.

But earthquake prediction carries with it a whiff of sorcery and black magic, of ladies with long dangling earrings in dark tents reading the palm of your hand. Geologists and seismologists involved in earthquake prediction research find themselves sharing the media spotlight with trendy astrologers, some with business cards, armed with maps and star charts. I heard about one woman on the Oregon coast who claims to become so ill before natural disasters—that have included major California earthquakes and the eruption of Mt. St. Helens—that she has to be hospitalized. After the disaster, she recovers dramatically. Jerry Hurley, a high-school math teacher in Fortuna, California, would get migraine headaches and a feeling of dread before an earthquake. His symptoms were worst when he faced

in the direction of the impending earthquake. Hurley is a member of MENSA, the organization for people with high IQ, and he would just as soon somebody else had this supposed “talent.”

Some of these people claim that their predictions have been ignored by those in authority, especially the USGS, which has the legal responsibility to advise the president of the United States on earthquake prediction. They go directly to the media, and the media see a big story.

A self-styled climatologist named Iben Browning forecast a disastrous earthquake on December 3, 1990, in the small town of New Madrid, Missouri. The forecast was picked up by the media, even after a panel of experts, the National Earthquake Prediction Evaluation Council (NEPEC), had thoroughly reviewed Browning’s prediction and had concluded in October of that year that the prediction had no scientific basis. By rejecting Browning’s prediction, the nay-saying NEPEC scientists inadvertently built up the story. Browning, who held a PhD degree in zoology from the University of Texas, had based his prediction on a supposed 179-year tidal cycle that would reach its culmination on December 3, exactly 179 years after a series of earthquakes with magnitudes close to 8 had struck the region. His prediction had been made in a business newsletter that he published with his daughter and in lectures to business groups around the country. Needless to say, he sold lots of newsletters.

Despite the rejection of his prediction by the

seismological establishment, Browning got plenty of attention, including an interview on *Good Morning America*. As the time for the predicted earthquake approached, more than thirty television and radio vans with reporting crews descended on New Madrid. School was let out, and the annual Christmas parade was canceled. Earthquake T-shirts sold well, and the Sandywood Baptist Church in Sikeston, Mo., announced an Earthquake Survival Revival.

The date of the earthquake came and went. Nothing happened. The reporters and TV crews packed up and went home, leaving the residents of New Madrid to pick up the pieces of their lives. Browning instantly changed from earthquake expert to earthquake quack, and he became a broken man. He died a few months later.

The USGS once funded a project to evaluate every nonscientific forecast it could find, including strange behavior of animals before earthquakes, to check out the possibility that some people or animals could sense a premonitory change not measured by existing instruments. Preliminary findings indicated no statistical correlation whatsoever between human forecasts or animal behavior and actual events. The project was aborted for fear that it might earn the Golden Fleece Award of then-Senator William Proxmire of Wisconsin for the month's most ridiculous government waste of taxpayers' money.

## 2. Earthquake Forecasting by Scientists

Most of the so-called predictors, including those who have been interviewed on national television, will claim that an earthquake prediction is successful if an earthquake of *any* magnitude occurs in the region. Let's say that I predict that an earthquake will occur in the Puget Sound region within a two-week period of June of this year. An earthquake occurs, but it is of M 2, not "large" by anyone's definition. Enough M 2 earthquakes occur randomly in western Washington that a person predicting an earthquake of unspecified magnitude in this area is likely to be correct. Or say that a person predicts that an earthquake of M 6 or larger will occur somewhere in the world in June of this year. It is quite likely that some place will experience an earthquake of that size around that time. Unless damage is done, this earthquake might not make the newspapers or the evening news, except that the predictor would point to it as a successful prediction ignored by the scientific establishment.

To issue a legitimate prediction, a scientist, or anyone else, for that matter, must provide an approximate *location*, *time*, and *magnitude*, and the prediction must be made in such a way that its legitimacy can be checked. The prediction could be placed in a sealed envelope entrusted to a respected individual or group, which would avoid frightening the public in case the prediction was wrong. But for a prediction to be of



value to society, it *must* be made public, but until prediction becomes routine (if it ever does), one must consider the negative impact on the public of a prediction that fails.

Prediction was one of the major goals of the federal earthquake program when it was established in 1977, and at one time it looked as if that goal might be achieved sooner than expected. In the early 1970s, a team of seismologists at Columbia University suggested that the speed of earthquake waves passing through the Earth's crust beneath the site of a future earthquake would become slower, then return to normal just before the event. The changes in speed of earthquake waves had been noted before small earthquakes in the Adirondacks of New York State and in Soviet Central Asia.

In 1973, Jim Whitcomb, a seismologist at Caltech, reported that seismic waves had slowed down, then speeded up just before a M 6.7 earthquake in 1971 in the northern San Fernando Valley suburb of Los Angeles. Two years later, he observed the same thing happening near the aftershock zone of that earthquake: a slowdown of earthquake waves, presumably to be followed by a return to normal speed and another earthquake. Other seismologists disagreed. Nonetheless, Whitcomb issued a “forecast”—not his term, for he characterized it as “a test of a hypothesis.” If the changes in the speed of earthquake waves were significant, then there should be another earthquake

of magnitude 5.5 to 6.5 in an area adjacent to the 1971 shock in the next twelve months.

My students and I happened to be doing field work on an active fault just west of the San Fernando Valley during this twelve-month period. Each night the coyotes started to howl, we would bolt upright from our sleeping bags at our campsite along the fault and wonder if we were about to have an earthquake.

Whitcomb became an overnight celebrity and was written up in *People* magazine. An irate Los Angeles city councilman threatened to sue both Whitcomb and Caltech. In the meantime, the predicted time span for the earthquake ran out, with no earthquake. Meanwhile, other scientists tested the Columbia University theory and found a relatively poor correlation between the variation in speed of earthquake waves in the crust and future earthquakes. (Maybe Whitcomb was right in location but off on the time and magnitude. The Northridge Earthquake struck the San Fernando Valley 23 years after the earlier earthquake; its magnitude was 6.7, larger than expected.)

At about the same time as the San Fernando “test of a hypothesis,” a prediction was made by Brian Brady, a geophysicist with the U.S. Bureau of Mines, who worked in the field of mine safety (Olson, 1989). Between 1974 and 1976, Brady published a series of papers in an international peer-reviewed scientific journal, *Pure and Applied Geophysics*, in which he argued that characteristics of rock failure leading to wall collapses

in underground mines are also applicable to earthquakes. Brady's papers combined rock physics and mathematical models to provide what he claimed to be an earthquake "clock" that would provide the precise time, place, and magnitude of a forthcoming earthquake. Brady observed that earthquakes in 1974 and 1975 near Lima, Peru, had occurred in a region where there had been no earthquakes for a long time, and he forecast a much larger earthquake off the coast of central Peru. Brady's work received support from William Spence, a respected geophysicist with the USGS.

His prediction received little attention at first, but gradually it became public, first in Peru, where the impact to Lima, a city of more than seven million people, would be enormous, later in the United States, where various federal agencies grappled with the responsibility of endorsing or denying a prediction that had very little support among mainstream earthquake scientists. The prediction received major media attention when Brady announced that the expected magnitude would be greater than 9, and the preferred date for the event was June 28, 1981. The Peruvian government asked the U.S. government to evaluate the prediction that had been made by one of its own government scientists. In response to Peru's request, a NEPEC meeting was convened in January 1981, to evaluate Brady's prediction and to make a recommendation to the director of the USGS on how to

advise the Peruvians. The panel of experts considered the Brady and Spence prediction and rejected it.

Did the NEPEC report make the controversy go away? Not at all, and Brady himself was not convinced that his prediction had no scientific merit. An interview of Brady by Charles Osgood of *CBS News* shortly after the January NEPEC meeting was not broadcast until June 1981, close to the predicted arrival time of the earthquake. Officials of the Office of Foreign Disaster Assistance took up Brady's cause, and the NEPEC meeting was described as a "trial and execution." The NEPEC panel of experts was labeled a partisan group ready to destroy the career of a dedicated scientist rather than endorse his earthquake prediction.

John Filson, an official with the USGS, made a point of being in Lima on the predicted date of the earthquake to reassure the Peruvian public. The earthquake did not keep Brady's appointment with Lima, Peru. It has not arrived to this day.

### 3. Forecasts Instead of Predictions: The Parkfield Experiment

A more sophisticated but more modest forecast was made by the USGS for the San Andreas Fault at Parkfield, California, a backcountry village in the Central Coast Ranges. Before proceeding, we must

distinguish between the term *prediction*, such as that made by Brady for Peru, in which it is proposed that an earthquake of a specified magnitude will strike a specific region in a restricted time window (hours, days, or weeks), and the term *forecast*, in which a specific area is identified as having a higher statistical chance of an earthquake in a time window measured in months or years. Viewed in this way, the USGS made a forecast, not a prediction, at Parkfield.

Parkfield had been struck by earthquakes of M 5.5 to 6.5 in 1901, 1922, 1934, and 1966, and newspaper reports suggested earlier earthquakes in the same vicinity in 1857 and 1881. These earthquakes came with surprising regularity every twenty-two years, give or take a couple of years, except for 1934, which struck ten years early. The 1966 earthquake arrived not twenty-two but thirty-two years later, resuming the schedule followed by the 1922 and earlier earthquakes. The proximity of Parkfield to seismographs that had been operated for many years by the University of California, Berkeley, led to the interpretation that the last three earthquake epicenters were in nearly the same spot. Furthermore, foreshocks prior to the 1966 event were similar in pattern to foreshocks recorded before the 1934 earthquake.

Scientists at the USGS viewed Parkfield as a golden opportunity to “capture” the next earthquake with a sophisticated, state-of-the-art array of instruments. These instruments were installed to detect very small earthquakes, changes in crustal strain, changes of

water level in nearby monitored wells, and changes in the Earth's magnetic and electrical fields. The strategy was that detection of these subtle changes in the Earth's crust might lead to a short-term prediction and aid in forecasting larger earthquakes in more heavily populated regions.

At the urging of the California Office of Emergency Services, the USGS took an additional step by issuing an earthquake forecast for Parkfield. In 1984, it was proposed that there was a 95 percent chance, or probability, that an earthquake of magnitude similar to the earlier ones would strike Parkfield sometime in the period 1987 to 1993. A system of alerts was established whereby civil authorities would be notified in advance of an earthquake. Parkfield became a natural laboratory test site where a false alarm would not have the social impact of a forecast in, say, San Francisco or Los Angeles.

The year 1988, the twenty-second anniversary of the 1966 shock, came and went with no earthquake. The next five years passed; still no earthquake. By January 1993, when the earthquake had still not occurred, the forecast was sort of, but not exactly, a failure. The 5 percent probability that there *wouldn't* be an earthquake won out over the 95 percent probability that there *would* be one.

The Parkfield forecast experiment is like a man waiting for a bus that is due at noon. Noon comes and goes, then ten minutes past noon, then twenty past. No bus. The man looks down the street and figures that

the bus will arrive any minute. The longer he waits, the more likely the bus will show up. In earthquake forecasting, this is called a *time-predictable model*: the earthquake will follow a schedule, like the bus.

But there is another view: that the longer the man waits, the less likely the bus will arrive. Why? The bus has had an accident, or a bridge collapsed somewhere on the bus route. The “accident” for Parkfield might have been an earthquake of M 6.7 in 1983, east of Parkfield, away from the San Andreas Fault, near the oil-field town of Coalinga in the San Joaquin Valley. The Coalinga Earthquake may have redistributed the stresses building up on the San Andreas Fault to disrupt the twenty-two-year earthquake “schedule” at Parkfield.

## 4. The Seismic Gap Theory

Another idea of the 1970s was the *seismic gap theory*, designed for subduction zones around the Pacific Rim, but applicable also to the San Andreas Fault. According to theories of plate tectonics, there should be about the same amount of slip over thousands of years along all parts of a subduction zone like the Aleutians or Central America (or central Peru, for that matter, leading Brady toward his prediction). Most of the slip on these subduction zones should be released as great earthquakes. But some segments of each subduction

zone have been seismically quiet a lot longer than adjacent segments, indicating that those segments that have gone the longest without an earthquake are the most likely to be struck by a future earthquake. This is a variation of the time-predictable model, of waiting for the bus. The longer you wait, the more likely the bus (or earthquake) will show up.

The San Andreas Fault ruptured in earthquakes in 1812, 1857, and 1906, and smaller earthquakes at Parkfield more frequently than that. But the southeasternmost section of the fault from San Bernardino to the Imperial Valley has not ruptured in the 230 years people have been keeping records. Paleoseismological evidence shows that the last major earthquake struck around A.D. 1680, meaning that this section has gone more than three hundred years without a major earthquake. According to the time-predictable model, this part of the fault is “nine and a half months pregnant,” to quote one paleoseismologist. Is this reach of the fault the most likely location of the next San Andreas earthquake, or have other earthquakes in the region altered the schedule, as at Parkfield?

How good is the seismic gap theory in forecasting? In the early 1990s, Yan Kagan and Dave Jackson, geophysicists at UCLA, compared the statistical prediction in 1979 of where earthquakes should fill seismic gaps in subduction zones with the actual experience in the following ten years. If the seismic gap theory worked, then the earthquakes of the 1980s



should neatly fill the earthquake-free gaps in subduction zones identified in the 1970s. But the statistical correlation between seismic gaps and earthquakes of the next decade was found to be poor. Some seismic gaps had been filled, of course, but earthquakes also struck where they had not been expected, and some seismic gaps remain unfilled to this day, including the San Andreas Fault southeast of San Bernardino.

The Japanese had been intrigued by the possibility of predicting earthquakes even before a federal earthquake-research program was established in the United States. Like the early stages of the program in the U.S., the Japanese focused on prediction, with their major efforts targeting the Tokai area along the Nankai Subduction Zone southwest of Tokyo. Like the San Andreas Fault at Parkfield, the Nankai Subduction Zone appeared to rupture periodically, with major M 8 earthquakes in 1707, 1854, and a pair of earthquakes in 1944 and 1946. But the Tokai area, at the east end of the Nankai Subduction Zone, did not rupture in the 1944-1946 earthquake cycle, although it had ruptured in the previous two earthquakes. Like Parkfield, the Tokai Seismic Gap was heavily instrumented by the Japanese in search of short-term precursors to an earthquake. Unlike Parkfield, Tokai is a heavily populated area, and the benefits to society of a successful earthquake warning there would be very great.

According to some leading Japanese seismologists, there are enough geologic differences between the

Tokai segment of the Nankai Subduction Zone and the rest of the zone that ruptured in 1944 and 1946 to explain the absence of an earthquake at Tokai in the 1940s. One view is that the earlier earthquakes at Tokai in 1707 and 1854 were on local crustal faults, not the east end of the subduction zone, which implies that they would have no bearing on a future subduction-zone earthquake. The biggest criticism was that the Japanese were putting too many of their eggs in one basket: concentrating their research on the Tokai prediction experiment at the expense of a broader-based study throughout the country. The folly of this decision became apparent in January, 1995, when the Kobe Earthquake ruptured a relatively minor strike-slip fault far away from Tokai (Figure 7-1). The Kobe fault had been identified by Japanese scientists as one of twelve “precautionary faults” in a late stage of their seismic cycle, but no official action had been taken.

After the Kobe Earthquake, the massive Japanese prediction program was subjected to an intensive critical review. In 1997, the Japanese concluded at a meeting that their prediction experiment was not working—but they elected to continue supporting it anyway, although at a reduced level. Similarly, research dollars are still being invested at Parkfield, but the experiment has gone back to its original goal: an attempt to “capture” an earthquake in this well-studied natural laboratory and to record it with the network of instruments set up in the mid-1980s and upgraded since then. Indeed, Parkfield has already taught us a lot

about the earthquake process. In 2004, the Parkfield array did, indeed, “capture” an earthquake of M 6, which, however, arrived thirty-eight years late.

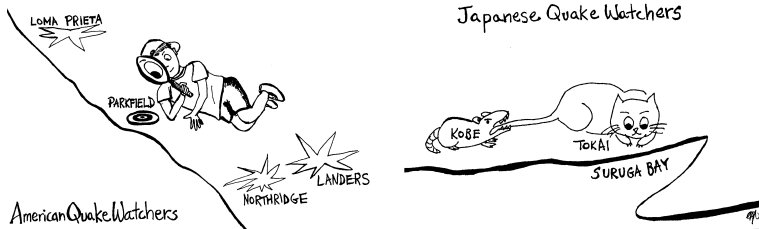

Cartoonist: Morika Tsujimura Figure 7-1. American and Japanese forecasting strategies, from Scholz (1997).

## 5. Have the Chinese Found the Way to Predict Earthquakes?

Should we write off the possibility of predicting earthquakes as simply wishful thinking? Before we do so, we must first look carefully at earthquake predictions in China, a nation wracked by earthquakes repeatedly throughout its long history. More than eight hundred thousand people lost their lives in an earthquake in north-central China in 1556, and another one hundred eighty thousand died in an earthquake in 1920.

During the Zhou Dynasty, in the first millennium B.C., the Chinese came to believe that heaven gives wise and virtuous leaders a mandate to rule, and removes this

mandate from heaven if the leaders are evil or corrupt. This became incorporated into the Taoist view that heaven expresses its disapproval of bad rule through natural disasters such as floods, plagues, or earthquakes.

In March 1966, the Xingtai Earthquake of M 7.2 struck the densely populated North China Plain two hundred miles southwest of the capital city of Beijing, causing more than eight thousand deaths. It might have been a concern about the mandate from heaven that led Premier Zhou Enlai to make the following statement: “There have been numerous records of earthquake disasters preserved in ancient China, but the experiences are insufficient. It is hoped that you can summarize such experiences and will be able to solve this problem during this generation.”

This call for action may be compared to President Kennedy’s call to put a man on the Moon by the end of the 1960s. Zhou had been impressed by the earthquake-foreshock stories told by survivors of the Xingtai Earthquake, including a M 6.8 event fourteen days before the mainshock, fluctuations in groundwater levels, and strange behavior of animals. He urged a prediction program “applying both indigenous and modern methods and relying on the broad masses of the people.” In addition to developing technical expertise in earthquake science, China would also involve thousands of peasants who would monitor water wells and observe animal behavior. Zhou did not trust the existing scientific establishment, including the

Academia Sinica and the universities, and he and Mao Zedong created an independent government agency, the State Seismological Bureau (SSB), in 1970.

Following an earthquake east of Beijing in the Gulf of Bohai in 1969, it was suggested that earthquakes after the Xingtai Earthquake were migrating northeast toward the Gulf of Bohai and Manchuria. Seismicity increased, the Earth's magnetic field underwent fluctuations, and the ground south of the city of Haicheng in southern Manchuria rose at an anomalously high rate. This led to a long-range forecast that an earthquake of moderate magnitude might strike the region in the next two years. Monitoring was intensified, earthquake information was distributed, and thousands of amateur observation posts were established to monitor various phenomena. On December 22, 1974, a swarm of more than one hundred earthquakes, the largest of M 4.8, struck the area of the Qinwo Reservoir near the city of Liaoyang. At a national meeting held in January 1975, an earthquake of M 6 was forecast somewhere within a broad region of southern Manchuria.

As January passed into February, anomalous activity became concentrated near the city of Haicheng. Early on February 4, more than five hundred small earthquakes were recorded at Haicheng. This caused the government of Liaoning Province to issue a short-term earthquake alert. The people of Haicheng and nearby towns were urged to move outdoors on the unusually warm night of February 4. The large number

of foreshocks made this order easy to enforce. Not only did the people move outside into temporary shelters, they also moved their animals and vehicles outside as well. So when the M 7.3 earthquake arrived at 7:36 p.m., casualties were greatly reduced, even though in parts of the city, more than 90 percent of the houses collapsed. Despite a population in the epicentral area of several million people, only about one thousand people died. Without the warning, most people would have been indoors, and losses of life would have been many times larger. China had issued the world's first successful earthquake prediction.

However, in the following year, despite the intense monitoring that had preceded the Haicheng Earthquake, the industrial city of Tangshan, 220 miles southwest of Haicheng, was struck without warning by an earthquake of M 7.5-7.6. The Chinese gave an official estimate of about two hundred fifty thousand people killed. Unlike Haicheng, there were no foreshocks. And there was no general warning.

What about the mandate from heaven? The Tangshan Earthquake struck on July 28, 1976. The preceding March had seen major demonstrations in Tiananmen Square by people laying wreaths to the recently deceased pragmatist Zhou Enlai and giving speeches critical of the Gang of Four, radicals who had ousted the pragmatists, including Deng Xiaoping, who would subsequently return from disgrace and lead the country. These demonstrations were brutally put down by the military (as they would be again in 1989), and

Deng was exiled. The Gang of Four had the upper hand. But after the Tangshan Earthquake, Chairman Mao Zedong died and was succeeded by Hua Guofeng. The Gang of Four, including Mao's wife, opposed Hua, but Hua had them all arrested on October 6. Deng Xiaoping returned to power in 1977 and launched China's progress toward becoming a superpower, with greatly increased standards of living for its citizens. One could say that the mandate from heaven had been carried out!

Was the Haicheng prediction a fluke? In August 1976, the month following the Tangshan disaster, the Songpan Earthquake of M 7.2 was successfully predicted by the local State Seismological Bureau. And in May 1995, a large earthquake struck where it was predicted in southwestern China. Both predictions resulted in a great reduction of casualties. As at Haicheng, both earthquakes were preceded by foreshocks.

Why have the Chinese succeeded where the rest of the world has failed? For one thing, Premier Zhou's call for action led to a national commitment to earthquake research unmatched by any other country. Earthquake studies are concentrated in the China Earthquake Administration (CEA, the new name for the SSB), with a central facility in Beijing, and laboratories in every province. The CEA employs thousands of workers, and seismic networks cover the entire country. Earthquake preparedness and precursor monitoring are carried out at all levels of government, and, in keeping with Chairman Mao's view that progress rests with "the

broad masses of the people,” many of the measurements are made by volunteers, including school children.

Even so, perhaps most and possibly all of the apparent Chinese success is luck. All of the successful forecasts included many foreshocks, and at Haicheng the foreshocks were so insistent that it would have taken a major government effort for the people *not* to take action and move outdoors on the night of February 4. The Haicheng earthquake was the largest earthquake in an earthquake swarm, whereas the Tangshan earthquake in the following year was a mainshock followed by aftershocks. No major earthquake in recent history in the United States or Japan is known to have been preceded by enough foreshocks to lead to a short-term prediction useful to society. Also, despite the few “successful” predictions in China, many predictions have been false alarms, and the Chinese have not been forthright in publicizing their failures. These false alarms are more than would have been acceptable in a Western country. In addition, the Wenchuan earthquake of M 7.9 in Sichuan Province killed more than 80,000 people. It was not predicted.

## 6. A Strange Experience in Greece

On a pleasant Saturday morning in May 1995, the townspeople of Kozáni and Grevena in northwestern



Greece were rattled by a series of small earthquakes that caused people to rush out of their houses. While everyone was outside enjoying the spring weather, an earthquake of M 6.6 struck, causing more than \$500 million in damage, but no one was killed. Just as at Haicheng, the foreshocks alarmed people, and they went outside. The saving of lives was not due to any official warning; the people simply did what they thought would save their lives.

No official warning? Into the breach stepped Panayiotis Varotsos, a solid-state physicist from the University of Athens. For more than fifteen years, Varotsos and his colleagues Kessar Alexopoulos and Konstantine Nomicos have been making earthquake predictions based on electrical signals they have measured in the Earth using a technique called VAN, after the first initials of the last names of its three originators. Varotsos claimed that his group had predicted an earthquake in this part of Greece some days or weeks before the Kozáni-Grevena Earthquake, and after the earthquake he took credit for a successful prediction. Varotsos had sent faxes a month earlier to scientific institutes abroad pointing out signals indicating that an earthquake would occur in this area. But the actual epicenter was well to the north of either of two predicted locations, and the predicted magnitude was much lower than the actual earthquake, off by a factor of 1,000 in energy release.

The VAN prediction methodology has changed over the past two decades. The proponents say they can

predict earthquakes of magnitude greater than M 5 one or two months in advance, including a devastating earthquake near Athens in 1999. As a result, Varotsos' group at Athens received for a time about 40 percent of Greece's earthquake-related research funds, all without review by his scientific colleagues. His method has been widely publicized in Japan, where the press implied that if the VAN method had been used, the Kobe Earthquake would have been predicted. Although several leading scientists believe that the VAN method is measuring something significant, the predictions are not specific as to time, location, and magnitude. However, VAN has received a lot of publicity in newspapers and magazines, on television, and even in Japanese comic books.

This section on prediction concludes with two quotations from eminent seismologists separated by more than fifty years.

In 1946, the Jesuit seismologist, Father James Macelwane, wrote in the *Bulletin of the Seismological Society of America*: "The problem of earthquake forecasting [he used the word *forecasting* as we now use *prediction*] has been under intensive investigation in California and elsewhere for some forty years, and we seem to be no nearer a solution of the problem than we were in the beginning. In fact the outlook is much less hopeful."

In 1997 Robert Geller of Tokyo University wrote in *Astronomy & Geophysics*, the Journal of the Royal Astronomical Society: "The idea that the Earth

telegraphs its punches, i.e., that large earthquakes are preceded by observable and identifiable precursors—isn't backed up by the facts.”

## 7. Reducing Our Expectations: Forecasts Rather Than Predictions

Our lack of success in predicting earthquakes has caused earthquake program managers, even in Japan, to cut back on prediction research and focus on earthquake engineering, the effects of earthquakes, and the faults that are the sources of earthquakes. Yet in a more limited way, we can say something about the future; indeed, we must, because land-use planning, building codes, and insurance underwriting depend on it. We do this by adopting the strategy of weather forecasting—20 percent chance of rain tonight, 40 percent tomorrow.

Earthquake forecasting, a more modest approach than earthquake prediction, is more relevant to public policy and our own expectations about what we can tell about future earthquakes. The difference between an earthquake prediction and an earthquake forecast has already been stated: a prediction specifies time, place, and magnitude of a forthcoming earthquake, whereas a forecast is much less specific.

Two types of forecasts are used: *deterministic* and

*probabilistic*. A deterministic forecast estimates the largest earthquake that is likely on a particular fault or in a given region. A probabilistic forecast deals with the likelihood of an earthquake of a given size striking a particular fault or region within a future time interval of interest to society.

An analogy may be made with hurricanes. The National Weather Service can forecast how likely it is that southern Florida may be struck by a hurricane as large as Hurricane Andrew in the next five years; this is probabilistic. It could also forecast how large a hurricane could possibly be: 200-mile-per-hour winds near the eye of the storm, for example. This is deterministic.

## 8. The Deterministic Method

The debate in Chapter 4 about “instant of catastrophe” or “decade of terror” on the Cascadia Subduction Zone—whether the next earthquake will be of magnitude 8 or 9—is in part a deterministic discussion. Nothing is said about when such an earthquake will strike, only that such an earthquake of magnitude 9 is possible, or credible. We have estimated the *maximum credible (or considered) earthquake*, or MCE, on the Cascadia Subduction Zone.

We know the length of the Cascadia Subduction Zone from northern California to Vancouver Island, and,

based on slip estimated from other subduction zones worldwide and on our own paleoseismic estimates of the greatest amount of subsidence of coastal marshes during an earthquake (“what has happened can happen”), we can estimate a maximum moment magnitude, assuming that the entire subduction zone ruptures in a single earthquake (Figure 7-2). The moment magnitude of an earthquake rupturing the entire subduction zone at once, with slip estimated from subsidence of marshes, would be about magnitude 9. However, the largest expected earthquake might only rupture only part of the subduction zone with a maximum magnitude of only 8.2 to 8.4. These alternatives are shown in Figure 7-2, remembering that most scientists now favor a MCE of magnitude 9. However, Chris Goldfinger’s work has shown that some earthquakes rupture only the southern part of the subduction zone, as illustrated in the middle and righthand maps in Figure 7-2.

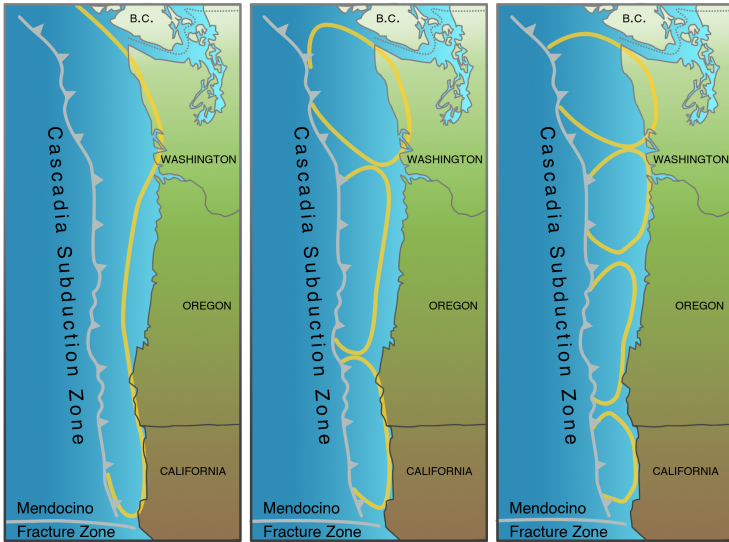

Figure 7-2. The deterministic choices for the maximum considered earthquake on the Cascadia Subduction Zone. (Left) The entire subduction zone ruptures at the same time, resulting in an earthquake of MW 9+. (Center and right) Segments of the subduction zone of various sizes rupture independently, resulting in smaller earthquakes. Modified from Alan Nelson and Stephen Personius, USGS

Some probability is built into a deterministic assessment. A nuclear power plant is a critical facility and should be designed for a maximum considered earthquake, even if the recurrence time for it is measured in tens of thousands of years. The result of an earthquake-induced failure of the core reactor would be catastrophic, even if it is very unlikely. The importance of this is illustrated by the failure of the Tokyo Electric Power Company to allow for the

possibility of an earthquake as large as M 9 for the Tohoku nuclear power plant and offshore, resulting in nuclear contamination of nearby lands and the Pacific Ocean. Yet there is a limit. The possibility that the Pacific Northwest might be struck by a comet or asteroid, producing a version of nuclear winter and mass extinction of organisms (including ourselves), is real but is so remote, measured in tens of millions of years, that we do not incorporate it into our preparedness planning.

In the Puget Sound region, three deterministic estimates are possible: a magnitude 9 earthquake on the Cascadia Subduction Zone, the MCE on a crustal fault such as the Seattle Fault, and the MCE on the underlying Juan de Fuca Plate, which has produced most of the damage in the region to date. It is difficult to determine the MCE for the Juan de Fuca Plate; scientists guess that the 1949 earthquake of M 7.1 is about as large as a slab earthquake will get. However, the deep oceanic slab beneath Bolivia in South America generated an earthquake greater than M 8, so we really don't know what the MCE for the Juan de Fuca Plate should be. We will discuss the MCE on the Seattle fault after describing the Gutenberg-Richter relationship.

## 9. Probabilistic Forecasting

We turn now to *probabilistic forecasting*. Examples of

probability are: (1) the chance of your winning the lottery, (2) the chance of your being struck in a head-on collision on the freeway, or (3) the chance your house will be destroyed by fire. Even though you don't know if you will win the lottery or have your house burn down, the probability or likelihood of these outcomes is sufficiently well known that lotteries and gambling casinos can operate at a profit. You can buy insurance against a head-on collision or a house fire at a low enough rate that it is within most people's means, and the insurance company can show a profit (see Chapter 10).

In the probabilistic forecasting of earthquakes, we use geodesy, geology, paleoseismology, and seismicity to consider the likelihood of a large earthquake in a given region or on a particular fault sometime in the future. A time frame of thirty to fifty years is commonly selected, because that is close to the length of a home mortgage and is likely to be within the attention span of political leaders and the general public. A one-year time frame would yield a probability too low to get the attention of the state legislature or the governor, whereas a one-hundred-year time frame, longer than most life spans, might not be taken seriously, even though the probability would be much higher.



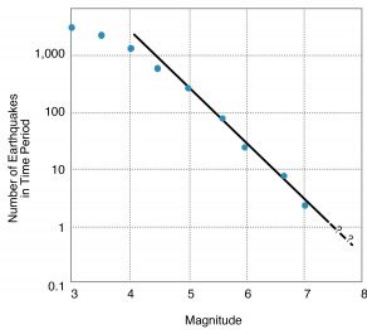

Figure 7-3. Illustration of the Gutenberg-Richter (G-R) relationship for thirty years of seismicity data for the Imperial Valley of southern California. Shown are the number of earthquakes of a given magnitude for the time period. Note that both scales are logarithmic, that is, each unit is ten times larger than the preceding one, as earlier discussed for magnitude. For this reason, the straight line may be somewhat misleading. The drop-off in seismicity for lower magnitudes is generally related to the sensitivity of the seismic network; it does not record all the smaller events. Projecting the straight line downward, G-R predicts 0.4 earthquakes of M 8 in the thirty-year time period, or one M 8 earthquake every seventy-five years. This prediction is questionable, as is the timing of still larger earthquakes. From C. R. Allen, Caltech, in Yeats et al. (1997)

In 1954, Beno Gutenberg and Charles Richter of Caltech studied the instrumental seismicity of different regions around the world and observed a systematic relationship between magnitude and frequency of small- to intermediate-size earthquakes.

Earthquakes of a given magnitude interval are about ten times more frequent than those of the next higher magnitude (Figure 7-3). The departure of the curve from a straight line at low magnitudes is explained by the inability of seismographs to measure very small earthquakes. These small events would only be detected when they are close to a seismograph; others that are farther away would be missed. So

Gutenberg and Richter figured that if the seismographs could measure all the events, they would fall on the same straight line as the larger events that are sure to be detected, no matter where they occur in the region of interest. Note that Figure 7-3 is logarithmic, meaning that larger units are ten times as large as smaller ones.

This is known as the *Gutenberg-Richter (G-R) relationship* for a given area. If the curve is a straight line, then only a few years of seismograph records of earthquakes of low magnitude could be extrapolated to forecast how often earthquakes of larger magnitudes not covered by the data set would occur.

A flaw in the assumptions built into the relationship (or, rather, a misuse of the relationship unintended by Gutenberg and Richter) is that the line would continue to be straight for earthquakes much larger than those already measured. For example, if the Gutenberg-Richter curve predicted one M 7 earthquake in ten years for a region, this would imply one M 8 per one hundred years, one M 9 per one thousand years, and one M 10 per ten thousand years! Clearly this cannot be so, because no earthquake larger than M 9.5 is known to have occurred. Clarence Allen of Caltech has pointed out that if a single fault ruptured all the way around the Earth, an impossible assumption, the magnitude of the earthquake would be only 10.6. So the Gutenberg-Richter relationship, used (or misused) in this way, fails us where we need it the most, in forecasting the frequency of the largest earthquakes that are most devastating to society.

Roy Hyndman and his associates at Pacific Geoscience Centre constructed a Gutenberg-Richter curve for crustal earthquakes in the Puget Sound and southern Georgia Strait regions (Figure 7-4). The time period of their analysis is fairly short because only in the past twenty years has it been possible to separate crustal earthquakes from those in the underlying Juan de Fuca Plate. They have reliable data for earthquakes of magnitudes 3.5 to 5 and less reliable data for magnitudes up to about 6.2. The frequency curve means one earthquake of magnitude 3.6 every year and 0.1 earthquake of magnitude 5.1 every year (or one earthquake of that magnitude every ten years). Extending the curve as

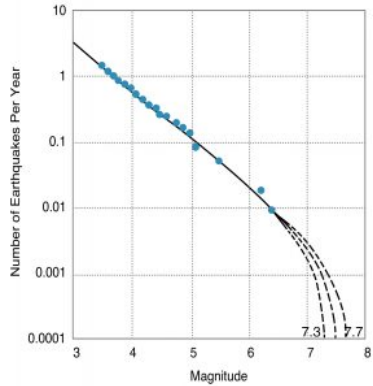

Figure 7-4. Gutenberg-Richter curve for crustal earthquakes in the Puget Sound and southern Georgia Strait region. The data are reliable for earthquakes of M 3.5 to 5 and less reliable for earthquakes of M about 6.2. The curve indicates 0.1 earthquake of M 5 per year, which is the same as one earthquake per ten years. An earthquake of M 6 would be expected every fifty years. The curve is not extended as a straight line to higher magnitudes, but instead is curved downward to approach a vertical line, which would be the maximum earthquake expected in the region (a deterministic estimate), estimated as M 7.3 to 7.7. From Roy Hyndman and Kelin Wang, Pacific Geoscience Centre

a straight line would predict one earthquake of magnitude 6 every fifty years.

Hyndman and his colleagues followed modern practice and did not extrapolate the G-R relationship as a straight line to still higher magnitudes. They showed the line curving downward to approach a vertical line, which would be the maximum magnitude, which they estimated as M 7.3 to 7.7. This would lead to an earthquake of magnitude 7 every four hundred years. Other estimates based on the geology lead to a maximum magnitude (MCE) of 7.3, a deterministic estimate. Assuming that most of the GPS-derived -crustal shortening between southern Washington and southern British Columbia takes place by earthquakes, there should be a crustal earthquake in this zone every four hundred years. The last earthquake on the Seattle Fault struck about eleven hundred years ago, but it is assumed that other faults in this region such as the Tacoma Fault or Southern Whidbey Island Fault might make up the difference. Thus geology and tectonic geodesy give estimates comparable to the Gutenberg-Richter estimate for M 7 earthquakes as long as G-R does not follow a straight line for the highest magnitudes.

This analysis works for Puget Sound and the Georgia Strait, where there is a large amount of instrumental seismicity. It assumes that the more earthquakes recorded on seismograms, the greater the likelihood of much larger earthquakes in the future. Suppose your region had more earthquakes of magnitudes below 7

than the curve shown in Figure 7-3. This would imply a larger number of big earthquakes and a greater hazard. At first, this seems logical. If you feel the effects of small earthquakes from time to time, you are more likely to worry about bigger ones.

Yet the instrumental seismicity of the San Andreas Fault leads to exactly the opposite conclusion. Those parts of the San Andreas Fault that ruptured in great earthquakes in 1857 and 1906 are seismically very quiet today. This is illustrated in Figure 7-5, a seismicity map of central California, with the San Francisco Bay Area in its northwest corner. The San Andreas Fault extends from the upper left to the lower right corner of this map. Those parts of the San Andreas Fault that release moderate-size earthquakes frequently, like Parkfield and the area northwest of Parkfield, stand out on the seismicity map. The fault is weakest in this area, and it is unlikely to store enough strain energy to release an earthquake as large as magnitude 7. However, the fault in the northwest corner of the map (part of the 1906 rupture of M 7.9) has relatively low instrumental seismicity, and the fault in the southeast corner (part of the 1857 rupture, also M 7.9) is not marked by earthquakes at all. The segments of the fault with the lowest instrumental seismicity have the potential for the largest earthquake, almost a magnitude 8.

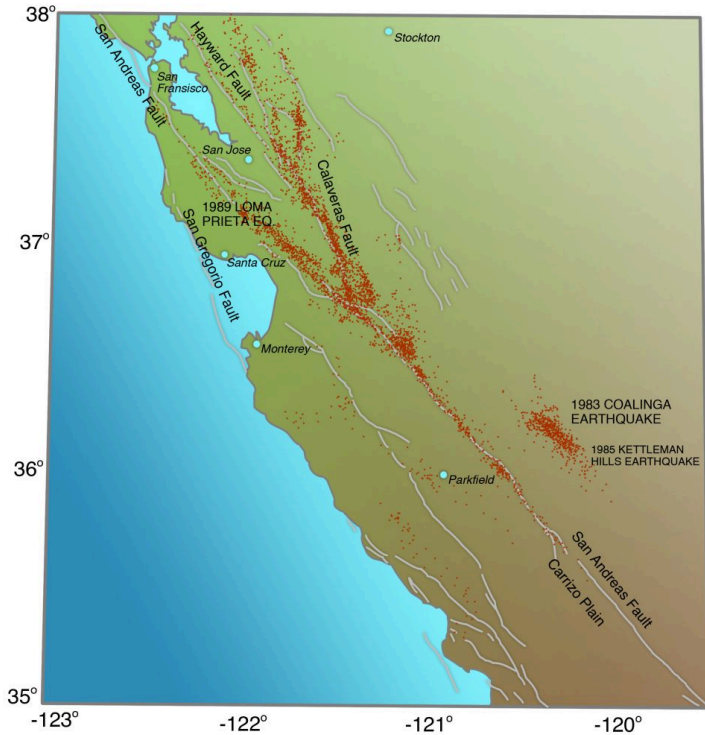

Figure 7-5. Seismicity of central California, 1980-1986, to compare the seismicity of that part of the San Andreas Fault that ruptured in 1857 (southeast, or lower right corner), which does not image the fault at all, to the seismicity of that part of the San Andreas Fault that ruptures frequently, as at Parkfield, or creeps accompanied by very small earthquakes, which images the fault very well. That part of the fault in the northwest, or upper left corner of the map, ruptured in 1906, but is not well imaged by microearthquakes. From David Oppenheimer, USGS

The Cascadia Subduction Zone has essentially zero instrumental seismicity north of California (Figure

4-13). Yet geological evidence and comparisons with other subduction zones provide convincing evidence that Cascadia has ruptured in earthquakes as large as magnitude 9, the last in January 1700.

This shows that the Gutenberg-Richter extrapolation to higher magnitudes works in those areas where there are many small- to moderate-size earthquakes, but not where the fault is completely locked. Seismicity, which measures the release of stored elastic strain energy, depends on the strength of the crust being studied. A relatively weak fault like the San Andreas Fault at Parkfield would have many small earthquakes, because the crust could not store enough strain to release a large one. A strong fault like the San Andreas Fault north of San Francisco would release few or no earthquakes until strain had built up enough to rupture the crust in a very large earthquake, such as the earthquake of April 18, 1906.

Paleoseismology confirms the problems in using the Gutenberg-Richter relationship to predict the frequency of large earthquakes. Dave Schwartz and Kevin Coppersmith, then of Woodward-Clyde Consultants in San Francisco, were able to identify individual earthquakes in backhoe trench excavations of active faults in Utah and California based on fault offset of sedimentary layers in the trenches. They found that fault offsets tend to be about the same for different earthquakes in the same backhoe trench, suggesting that the earthquakes producing the fault offsets tend to be about the same size. This led them to the concept

of *characteristic earthquakes*: a given segment of fault tends to produce the same size earthquake each time it ruptures to the surface. This would allow us to dig backhoe trenches across a suspect fault, determine the slip on the last earthquake rupture (preferably on more than one rupture event), and forecast the size of the next earthquake. When compared with the Gutenberg-Richter curve for the same fault, which is based on instrumental seismicity, the characteristic earthquake might be larger or smaller than the straight-line extrapolation would predict. Furthermore, the Gutenberg-Richter curve cannot be used to extrapolate to earthquake sizes larger than the characteristic earthquake. The characteristic earthquake is as big as it ever gets on that particular fault.

Before we get too impressed with the characteristic earthquake idea, it must be said that where the paleoseismic history of a fault is well known, like that part of the San Andreas Fault that ruptured in 1857, some surface-rupturing earthquakes are larger than others, another way of saying that not all large earthquakes on the San Andreas Fault are characteristic. Similarly, although we agree that the last earthquake on the Cascadia Subduction Zone was a magnitude 9, the evidence from subsided marshes at Willapa Bay, Washington (Figure 4-10a) and from earthquake-generated turbidites (Figure 4-9) suggests that some of the earlier ones may have been smaller or larger than an M 9.

This discussion suggests that no meaningful link may



exist between the Gutenberg-Richter relationship for small events and the recurrence and size of large earthquakes. For this relationship to be meaningful, the period of instrumental observation needs to be thousands of years. Unfortunately, seismographs have been running for only a little longer than a century, so that is not yet an option.

Before considering a probabilistic analysis for the San Francisco Bay Area in northern California, it is necessary to introduce the *principle of uncertainty*. There is virtually no uncertainty in the prediction of high and low tides, solar or lunar eclipses, or even the return period of Halley's Comet. These events are based on well-understood orbits of the Moon, Sun, and other celestial bodies. Unfortunately, the recurrence interval of earthquakes is controlled by many variables, as we learned at Parkfield. The strength of the fault may change from earthquake to earthquake. Other earthquakes may alter the buildup of strain on the fault, as the 1983 Coalinga Earthquake might have done for the forecasted Parkfield Earthquake that did not strike in 1988. Why does one tree in a forest fall today, but its neighbor of the same age and same growth environment takes another hundred years to fall? That is the kind of uncertainty we face with earthquake forecasting.

How do we handle this uncertainty? Figure 7-6 shows a *probability curve* for the recurrence of the next earthquake in a given area or along a given fault. Time in years advances from left to right, starting at zero

at the time of the previous earthquake. The chance of an earthquake at a particular time since the last earthquake increases upward at first. The curve is at its highest at that time we think the earthquake is most likely to happen (the average recurrence interval), and then the curve slopes down to the right. We feel confident that the earthquake will surely have occurred by the time the curve drops to near zero on the right side of the curve.

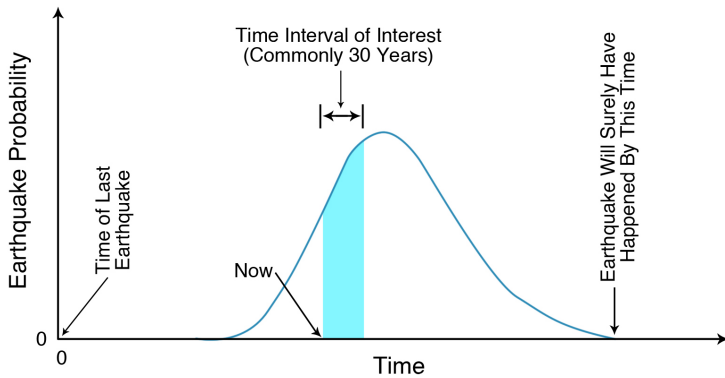

Figure 7-6. The probability for the recurrence of large earthquakes on a given fault or in a given region. Time increases from left to right, and the higher the curve, the greater the likelihood of an earthquake. The previous earthquake happened at time 0. The dark gray band is the time of interest for the probability calculation, commonly thirty years. The left side of the dark band is today. According to this probability, the earthquake will surely have happened by the time the probability curve returns to zero at the right side of the curve.

The graph in Figure 7-6 has a darker band, which

represents the time frame of interest in our probability forecast. The left side of the dark band is today, and the right side is the end of our time frame, commonly thirty years from now, the duration of most home mortgages. There is a certain likelihood that the earthquake will occur during the time frame we have selected.

This is similar to weather forecasting, except we are talking about a thirty-year forecast rather than a five-day forecast. If the meteorologist on the six-o'clock news says there is a 70 percent chance of rain tomorrow, this also means that there is a 30 percent chance that it will *not* rain tomorrow. The weather forecaster is often “wrong” in that the less likely outcome actually comes to pass. The earthquake forecaster also has a chance that the less-likely outcome will occur, as was the case for the 1988 Parkfield forecast.

Imagine turning on TV and getting the thirty-year earthquake forecast. The TV seismologist says, “There is a 70 percent chance of an earthquake of magnitude 6.7 or larger in our region in the next thirty years.” People living in the San Francisco Bay Area actually received this forecast in October 1999, covering a thirty-year period beginning in January 2000. That might not affect their vacation plans, but it should affect their building codes and insurance rates. It also means that the San Francisco Bay Area might *not* have an earthquake of M 6.7 or larger in the next thirty years (Figure 7-7). More about that forecast later.

How do we draw our probability curve? We consider

all that we know: the frequency of earthquakes based on historical records and geologic (paleoseismic) evidence, the long-term geologic rate at which a fault moves, and so on. A panel of experts is convened to debate the various lines of evidence and arrive at a consensus, called a logic tree, about probabilities. The debate is often heated, and agreement may not be reached in some cases. We aren't even sure that the curve in Figure 7-6 is the best way to forecast an earthquake. The process might be more irregular, even chaotic.

Our probability curve has the shape that it does because we know something about when the next earthquake will occur, based on previous earthquake history, fault slip rates, and so on. But suppose that we knew nothing about when the next earthquake would occur; that is to say, our data set had no "memory" of the last earthquake to guide us. The earthquake would be just as likely to strike one year as the next, and the probability "curve" would be a straight horizontal line. This is the same probability that controls your chance of flipping a coin and having it turn up heads: 50 percent. You could then flip the coin and get heads the next five times, but the sixth time, the probability of getting heads would be the same as when you started: 50 percent.

However, our probability curve is shaped like a bell; it "remembers" that there has been an earthquake on the same fault or in the same region previously. We know that another earthquake will occur, but we are unsure

about the displacement per event or the long-term slip rate, and nature builds in an additional uncertainty. The broadness of this curve builds in all these uncertainties.

Viewed probabilistically, the Parkfield forecast was not really a failure; the next earthquake is somewhere on the right side of the curve. We are sure that there *will* be another Parkfield Earthquake, but we don't know when the right side of the curve will drop down to near zero. Time 0 is 1966, the year of the last Parkfield Earthquake. The left side of the dark band is today. Prior to 1988, when the next Parkfield Earthquake was expected, the high point on the probability curve would have been in 1988. The time represented by the curve above zero would be the longest recurrence interval known for Parkfield, which would be thirty-two years, the time between the 1934 and 1966 earthquakes. That time is long past; the historical sample of earthquake recurrences at Parkfield, although more complete than for most faults, was not long enough. The next Parkfield earthquake actually occurred in 2004, which would have been to the right of the dark band in Figure 6-6 and possibly to the right of the zero line in that figure.

How about the next Cascadia Subduction Zone earthquake? Time 0 is A.D. 1700, when the last earthquake occurred. The left edge of the dark band is today. Let's take the width of the dark band as thirty years, as we did before. We would still be to the left of the high point in the probability curve. Our average recurrence interval based on paleoseismology is a little more than five hundred years, and it has only been

a bit more than three hundred years since the last earthquake. What should be the time when the curve is at zero again? Not five hundred years after 1700 because paleoseismology (Figures 4-9, 4-21) shows that there is great variability in the recurrence interval. The earthquake could strike tomorrow, or it could occur one thousand years after 1700, or A.D. 2700.

## **10. Earthquakes Triggered By Other Earthquakes: Do Faults Talk To Each Other?**

A probability curve for the Cascadia Subduction Zone or the San Andreas Fault treats these features as individual structures, influenced by neither adjacent faults nor other earthquakes. A 1988 probability forecast for the San Francisco Bay Area treated each fault separately.

But the 1992 Landers Earthquake in the Mojave Desert appears to have been triggered by earlier earthquakes nearby. The Landers Earthquake also triggered earthquakes hundreds of miles away, including an earthquake at the Nevada Test Site north of Las Vegas. The North Anatolian Fault, a San Andreas-type fault in Turkey, was struck by a series of earthquakes starting in 1939 and then continuing westward for the next sixty years, like falling dominoes,

culminating in a pair of earthquakes in 1999 at Izmit and Düzce that killed tens of thousands of people.

Ross Stein and his colleagues Bob Simpson and Ruth Harris of the USGS figure that an earthquake on a fault increases stress on some adjacent faults and decreases stress on others. An earthquake temporarily increases the probability of an earthquake on nearby faults because of this increased stress. For example, the Mojave Desert earthquakes might have advanced the time of the next great earthquake on the southern San Andreas Fault by about fourteen years. This segment of the fault has a relatively high probability anyway since it experienced its most recent earthquake around A.D. 1680, but the nearby Mojave Desert earthquakes might have increased the probability even more.

In the same way, a great earthquake can reduce the probability of an earthquake on nearby faults. In the San Francisco Bay Area, the seventy-five year period before the 1906 San Francisco Earthquake was unusually active, with at least fourteen earthquakes with magnitude greater than 6 on the San Andreas and East Bay faults. Two or three earthquakes were greater than M 6.8. But in the next seventy-five years after 1906, this same area experienced only one earthquake greater than M 6. It appears that the 1906 earthquake cast a stress shadow over the entire Bay Area, reducing the number of earthquakes that would have been expected based only on slip rate and the time of the most recent earthquake on individual faults. But the 1989 Loma

Prieta Earthquake and 2014 Napa Earthquake might mean that this quiet period is at an end.

However, to keep us humble, the 1989 Loma Prieta Earthquake has not been followed by other large earthquakes on nearby faults. Also, the 1992 Landers Earthquake was followed not by an earthquake on the southern San Andreas fault but by the Hector Mine Earthquake in an area where stress had been expected to be reduced, not raised. Maybe the Landers and Hector Mine earthquakes reduced rather than increased the probability of an earthquake on the southern San Andreas Fault. As in so many other areas of earthquake forecasting, nature turns out to be more complicated than our prediction models. Faults might indeed talk to each other, but we don't understand their language very well.

## **II. Forecasting the 1989 Loma Prieta Earthquake: Close But No Cigar**

Harry Reid of Johns Hopkins University started this forecast in 1910. Repeated surveys of benchmarks on both sides of the San Andreas Fault before the great San Francisco Earthquake of 1906 had shown that the crust deformed elastically before the earthquake, and the elastic strain was released during the earthquake.



Reid figured that all he had to do was to continue measuring the deformation of survey benchmarks, and when the elastic deformation had reached the stage that the next earthquake would release the same amount of strain as in 1906, the next earthquake would be close at hand.

In 1981, Bill Ellsworth of the USGS built on some ideas developed in Japan and the Soviet Union that considered patterns of instrumental seismicity as clues to an earthquake cycle. A great earthquake (in this case, the 1906 San Francisco Earthquake) was followed by a quiet period, then by an increase in the number of small earthquakes leading to the next big one. Ellsworth and his coworkers concluded that the San Andreas Fault south of San Francisco was not yet ready for another Big One. However, after seventy-five years of quiet after the 1906 earthquake, shocks of M6 to M7 similar to those reported in the nineteenth century could be expected in the next seventy years.

Most forecasts of the 1980s relied on past earthquake history and fault slip rates, and much attention was given to the observation that the southern end of the 1906 rupture, north of the mission village of San Juan Bautista, had moved only two to three feet, much less than in San Francisco or farther north. In 1982, Allan Lindh of the USGS wrote that an earthquake of magnitude greater than 6 could occur at any time on this section of the fault. His predicted site of the future rupture corresponded closely to the actual 1989 rupture, but his magnitude estimate was too low.

In 1985, at a summit meeting in Geneva, General Secretary Mikhail Gorbachev handed President Ronald Reagan a calculation by a team of Soviet scientists that forecast a *time of increased probability (TIP)* of large earthquakes in a region including central and most of southern California and parts of Nevada. This forecast was based on a sophisticated computer analysis of patterns of seismicity worldwide. In 1988, the head of the Soviet team, V. I. Keilis-Borok, was invited to the National Earthquake Prediction Evaluation Council (NEPEC) to present a modified version of his TIP forecast. He extended the time window of the forecast from the end of 1988 to mid-1992 and restricted the area of the forecast to a more limited region of central and southern California, an area that included the site and date of the future Loma Prieta Earthquake.

Several additional forecasts were presented by scientists of the USGS, including one that indicated that an earthquake on the Loma Prieta segment of the San Andreas Fault was unlikely. These, like earlier forecasts, were based on past earthquake history, geodetic changes, and patterns of seismicity, but none could be rigorously tested.

In early 1988, the Working Group on California Earthquake Probabilities (WGCEP) published a probability estimate of earthquakes on the San Andreas Fault System for the thirty-year period 1988-2018. This estimate was based primarily on the slip rate and earthquake history of individual faults, not on interaction among different faults in the region. It

stated that the thirty-year probability of a large earthquake on the southern Santa Cruz Mountains (Loma Prieta) segment of the San Andreas Fault was one in five, with considerable disagreement among working-group members because of uncertainty about fault slip on this segment. The working group forecast the likelihood of a somewhat smaller earthquake (M6.5 to M7) as about one in three, although this forecast was thought to be relatively unreliable. Still, this was the highest probability of a large earthquake on any segment of the fault except for the Parkfield segment, which was due for an earthquake that same year (an earthquake that did not arrive until 2004, when Parkfield was struck by an earthquake of M 6).

Then on June 27, 1988, a M 5 earthquake rattled the Lake Elsman-Lexington Reservoir area near Los Gatos, twenty miles northwest of San Juan Bautista and a few miles north of the northern end of the southern Santa Cruz Mountains segment described by WGCEP as having a relatively high probability for an earthquake. Allan Lindh of USGS told Jim Davis, the California State Geologist, that this was the largest earthquake on this segment of the fault since 1906, raising the possibility that the Lake Elsman Earthquake could be a foreshock. All agreed that the earthquake signaled a higher probability of a larger earthquake, but it was unclear how much the WGCEP probability had been increased by this event. On June 28, the California Office of Emergency Services issued a short-term earthquake advisory to local governments in Santa Clara, Santa

Cruz, San Benito, and Monterey counties, the first such earthquake advisory in the history of the San Francisco Bay Area. This short-term advisory expired on July 5.

On August 8, 1989, another M 5 earthquake shook the Lake Elsman area, and another short-term earthquake advisory was issued by the Office of Emergency Services. This advisory expired five days later. Two months after the advisory was called off, the M 6.9 Loma Prieta Earthquake struck the southern Santa Cruz Mountains, including the area of the Lake Elsman earthquakes.

So was the Loma Prieta Earthquake forecasted? The mainshock was deeper than expected, and the rupture had a large component of reverse slip, also unexpected, raising the possibility that the earthquake ruptured a fault other than the San Andreas. Some of the forecasts were close, and as Harry Reid had predicted eighty years before, much of the strain that had accumulated since 1906 was released. Still, the disagreements and uncertainties were large enough that none of the forecasters was confident enough to raise the alarm. It was a learning experience.

## 12. The 1990 Probability Forecast

The Working Group on California Earthquake Probabilities went back to the drawing boards, and a new probability estimate was issued in 1990, one year

after the Loma Prieta Earthquake. Like the earlier estimate, this one was based on the history and slip rate of individual faults, but unlike the earlier estimates, it gave a small amount of weight to interactions among faults. The southern Santa Cruz Mountains segment of the San Andreas Fault, which ruptured in 1989, was assigned a low probability of an earthquake of  $M$  greater than 7 in the next thirty years. The North Coast segment of the San Andreas Fault also was given a low probability, even though at the time of the forecast, it had been eighty-four years since the great 1906 earthquake on that segment. The mean recurrence interval on this segment is two to three centuries, and it is still fairly early in its cycle. On the other hand, probabilities on the Rodgers Creek-Hayward Fault in the East Bay Area, including the cities of Oakland and Berkeley, were raised to almost thirty percent in the next thirty years, about one chance in three.

### 13. The 1999 Bay Area Forecast

The new ideas of earthquake triggering and stress shadows from the 1906 earthquake, together with much new information about the paleoseismic history of Bay Area faults, led to the formation of a new working group of experts from government, academia, and private industry. This group considered all the major faults of the Bay Area, as well as a “floating earthquake” on a fault

the group hadn't yet identified. A summary of fault slip and paleoseismic data was published by the USGS in 1996. A new estimate was released on October 14, 1999, on the USGS web site and as a USGS Fact Sheet.

The new report raises the probability of an earthquake with magnitude greater than M 6.7 in the Bay Area in the next thirty years to 70 percent. Subsequent reviews by the Working Group on California Earthquake Probabilities (WGCEP) have not changed the estimates significantly. Figure 7-7 shows a forecast from 2007 to 2036, and the overall probability of an earthquake of this size or larger on one of the Bay Area faults is 63%. Earthquake probability on the Rodgers Creek Fault and the northern end of the Hayward Fault was given as 31 percent; the probability is somewhat lower on the northern San Andreas Fault, the rest of the Hayward Fault, and the Calaveras Fault. A two-out-of-three chance of a large earthquake is a sobering thought for residents of the Bay Area. These numbers will change in future estimates, but probably not by much.

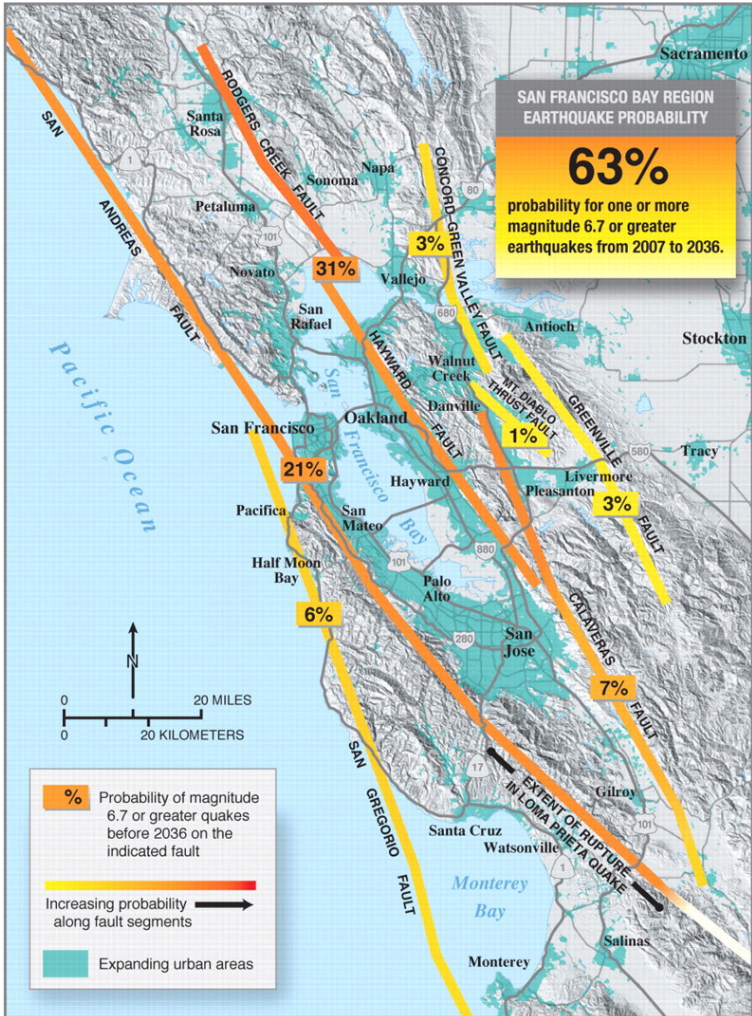

Figure 7-7. Replace with color map and replace caption as follows: Thirty-year probability of an earthquake of M 6.7 or larger in the San Francisco Bay Area during the period 2007-2036. The probability that one of the Bay Area faults will produce an earthquake this large or larger is 63%, or about two chances out of three. The probability that any given fault will produce this size earthquake in that time period is given for each fault. For example, the Hayward-Rodgers Creek fault has a 31% chance of rupturing, the San Andreas fault has a 21%

chance, and the Concord–Green Valley fault only 3%. This forecast is revised as new information becomes available. Source: USGS.

Figure 7-8 is a map showing earthquake probabilities for the entire state of California. The colors on the map are the probability for specific locations over the next thirty years, whereas Figure 7-7 is the probability for specific faults. Note the high probability of an earthquake in the California part of the Cascadia Subduction Zone. Note also that the San Andreas fault and the Hayward–Rodgers Creek fault are shown in bright red, indicating their high probability. The WGCEP estimates that there is more than 99% probability for at least one earthquake of M 6.7 or larger somewhere in California in the next thirty years!

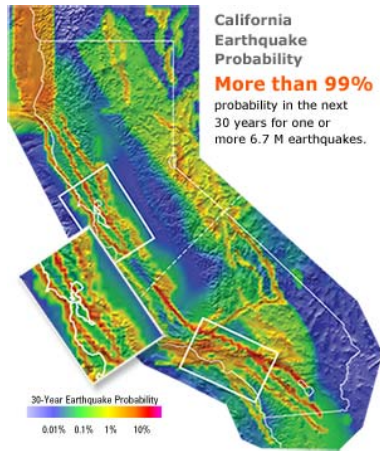

Figure 7-8. California 30-year earthquake probability expressed as colors, with red color indicating greater than 10% and blue indicating <0.01%. The orange color in northwestern California expresses the hazard from the Cascadia Subduction Zone. Source: WGCEP, Working Group on California Earthquake Probabilities.



What about the Northwest? Although we know quite a lot about the earthquake history of the Cascadia Subduction Zone, we know too little about the history of crustal faults and almost nothing about faults producing earthquakes in the Juan de Fuca Plate beneath Puget Sound and the Georgia Strait. Chris Goldfinger has estimated the 50-year probability of a Cascadia Subduction Zone earthquake based on the 10,000-year record based on turbidites. He estimates a 10-17 percent chance of a M 9 on the Washington coast and a 15-20 percent chance on the Oregon Coast during this period and a 37% chance of an earthquake of M 8-8.4 during this same period.

In the next chapters, we change our focus from probability of earthquakes of a certain magnitude to probability of strong shaking, which is more important in building codes and designing large structures. Here we have made some progress.

## 14. “Predicting” an Earthquake After It Happens

Seismic shock waves travel through the Earth’s crust much more slowly than electrical signals. A great earthquake on the Cascadia Subduction Zone will probably begin offshore, up to three hundred miles away from the major population centers of Vancouver,

Seattle, and Portland. Seismographs on the coast recording a large earthquake on the subduction zone could transmit the signal electronically to Seattle and Sidney more than a minute before strong ground shaking began. Earthquakes offshore detected using the SOSUS array could give even quicker warning. In addition, Richard Allen, now director of the University of California Berkeley Seismological Lab, and Hiroo Kanamori of Caltech have figured out a way to determine earthquake magnitude with no more than one second of P-wave data. This could give early warning of strong shaking even for slab earthquakes generated thirty to forty miles beneath the ground surface.

This early warning could trigger the shutdown of critical facilities in population centers before the shock wave arrived. Major gas mains could be shut off, schoolchildren could start a duck, cover, and hold drill (see Chapter 15), heavy machinery could be shut down, emergency vehicles could be parked outside, and hospitals could take immediate action in operating rooms. Automatic shutdown systems already exist to stop high-speed trains in Japan. Congress has charged the USGS with the job of submitting a plan to implement a real-time alert system; this is discussed further in Chapter 13. Estimated costs for implementing such a system over five years in the San Francisco Bay Area is \$53 million. An alert system is now being developed for the Pacific Northwest (Strauss, 2015).

Additional information on the proposed Advanced

National Seismic System, within which this alert system would operate, is available from Benz et al. (2000), USGS (1999), and <http://geohazard.cr.usgs.gov/pubs/circ>

## 15. What Lies Ahead

In New Zealand, Vere-Jones et al. (1998) proposed that we combine our probabilistic forecasting based on slip rates and estimated return times of earthquakes with the search for earthquake precursors. Geller (1997) has discounted the possibility that earthquakes telegraph their punches, and up to now, the Americans and Japanese have failed to find a “magic bullet” precursor that gives us a warning reliable enough that society can benefit. Yet precursors, notably earthquake foreshocks, gave advance warnings of earthquakes in China and Greece.

Possible precursors now under investigation include patterns in seismicity (such as foreshocks but in other instances a cessation of small earthquakes), changes in the fluid level of water wells, rapid changes in crustal deformation as measured by permanent GPS stations, anomalous electrical and magnetic signals from the Earth, faults being stressed by adjacent faults that recently ruptured in an earthquake, even the effects of Earth tides. For this method to be successful, massive amounts of data must be analyzed by high-speed

computers, so that real-time data can be compared quickly with other past data sets where the outcome is known. A single precursor might not raise an alarm, but several at the same time might lead to an alert. The mistake made by previous scientific predictors, including the Chinese, was to put too much dependence on a single precursor and an unrealistic view of how reliable that precursor would be in predicting time, location, and magnitude of a forthcoming earthquake.

In the future, we could see earthquake warning maps pointing out an increased risk beyond that based on earthquake history, analogous to maps showing weather conditions favorable to tornadoes, hurricanes, or wildfires. The TV seismologist or geologist could become as familiar as the TV meteorologist. If an earthquake warning were issued in this way, the public would be much better prepared than they would be if no warning had been issued, and there would be no panic, no fleeing for the exits. If no earthquake followed, the social impact would not be great, although local residents would surely be grouching about how the earthquake guys couldn't get it right. But they would be alive to complain.

Although we do not have a regional system in place, the USGS maintains an alert system at Parkfield on the San Andreas Fault and at Mammoth Lakes in the eastern Sierra, where volcanic hazard is present in addition to earthquake hazard. Unusual phenomena at either of these places are evaluated and reported to the

public. Pierce County, Washington, has established an alert system for possible mudflows from Mount Rainier (Figure 6-1). The monitoring system for metropolitan Los Angeles and the San Francisco Bay Area is becoming sophisticated enough that anomalous patterns of seismicity or other phenomena would be noticed by scientists and pointed out to the public. Indeed, the Lake Elsmere earthquakes of 1988 and 1989, prior to the Loma Prieta earthquake, were reported to the Office of Emergency Services, and alerts were issued. There are plans to extend this capability to cities of the Northwest.

## 16. Why Do We Bother With All This?

By now, you are probably unimpressed by probabilistic earthquake forecasting techniques. Although probabilistic estimates for well-known structures such as the Cascadia Subduction Zone and the San Andreas Fault are improving, it's unlikely that we'll be able to improve probability estimates for faults with low slip rates such as the Seattle and Portland Hills faults, unless we're more successful with short-term precursors. Yet we continue in our attempts, because insurance underwriters need this kind of statistical information to establish risks and premium rates. Furthermore, government agencies need to know if the long-term chances of an earthquake are high enough

to require stricter building codes, thereby increasing the cost of construction. This chapter began with a discussion of earthquake *prediction* in terms of yes or no, but probabilistic *forecasting* allows us to quantify the “maybes” and to say something about the uncertainties. Much depends on how useful the most recent forecast for the San Francisco Bay Area is, as well as others for southern California. Will the earthquakes arrive on schedule, or will they be delayed, as the 1988 Parkfield Earthquake was, or will the next earthquake strike in an unexpected place?

Why are we not farther along in scientifically reliable earthquake forecasting? The answer may lie in our appraisal in Chapter 2 of the structural integrity of the Earth’s crust—not well designed, not up to code. Some scientists believe that the Earth’s crust is in a state of critical failure—almost, but not quite, ready to break. In this view, the Earth is not like a strong well-constructed building that one can predict with reasonable certainty will not collapse. The crust is more like a row of old tenements, poorly built in the first place with shoddy workmanship and materials, and now affected by rot and old age. These decrepit structures will probably collapse some day, but which one will collapse first? Will the next one collapse tomorrow or ten years from now? This is the dilemma of the earthquake forecaster.

But society and our own scientific curiosity demand that we try.

## *Suggestions for Further Reading*

- Allen, R. W., and H. Kanamori, H. 2003. The potential for earthquake early warning in southern California. *Science*, v. 300, p. 786-89.
- Benz, H., J. Gilson, W. Arabasz, L. Gee, and L. Wald. 2000. Advanced National Seismic System Info Sheet; see also <http://geohazard.cr.usgs.gov/pubs/circ>
- Bolt, B. A. 2004. *Earthquakes*, 5th edition. New York: W.H. Freeman and Co., 378 p.
- Clarke, T. 1996. *California fault: searching for the spirit of state along the San Andreas*. New York: Ballantyne Books, 417 p.
- Crampin, S. 1999. Stress-forecasting earthquakes. *Seismological Research Letters*, v. 70, p. 291-93.
- Geller, R. J. 1997. Predictable publicity. *Seismological Research Letters*, v. 68, p. 477-80.
- Harris, R. A. 1998. The Loma Prieta, California, earthquake of October 17, 1989--forecasts. USGS Professional Paper 1550-B.
- Jackson, D.D., *Earthquake prediction and forecasting: American Geophysical Union Monograph 150*, p. 335-348.
- Jackson, D. D., Y. Kagan, and S. Uyeda. 1998. The VAN method of earthquake prediction. *EOS, Transactions of the American Geophysical Union*, v. 79, p. 573, 579-80. (Jackson and Kagan argue against, Uyeda argues for.)
- Jordan, T.H., and Jones, L.M., 2010. *Operational*

- earthquake forecasting: Some thoughts on why and how: *Seismological Research Letters*, v. 81, p. 571-574.
- Kanamori, H., E. Hauksson, and T. Heaton. 1997. Real-time seismology and earthquake hazard mitigation. *Nature*, v. 390, p. 481-84.
- Lomnitz, C. 1994. *Fundamentals of earthquake prediction*. New York: John Wiley & Sons, 326 p.
- Ma, Z., Z. Fu, Y. Zhang, C. Wang, G. Zhang, and D. Liu. 1990. *Earthquake prediction: Nine major earthquakes in China (1966-1976)*. Beijing: Seismological Press, and Berlin: Springer-Verlag, 332 p.
- Olson, R. S. 1989. *The politics of earthquake prediction*. Princeton, N.J.: Princeton University Press, 187 p. (Includes a description of the Brady earthquake prediction for Lima, Peru.)
- Reiter, L. 1990. *Earthquake hazard analysis: Issues and insights*. New York: Columbia University Press.
- Scholz, C. H. 1997. Whatever happened to earthquake prediction? *Geotimes*, v. 42, no. 3, p. 16-19. Spence, W., R. B. Herrmann, A. C. Johnston, and G. Reagor. 1993.
- Spence, W., R. B. Herrmann, A. C. Johnston, and G. Reagor. 1993. Response to Iben Browning's prediction of a 1990 New Madrid, Missouri, earthquake. *USGS Circular 1083*, 248 p.
- Stein, R. S. 2003. Earthquake conversations. *Scientific American*, v. 288, no. 1, p. 72-79 .
- Strauss, J., 2015, Vital seconds: The journey toward earthquake early warning for all: *Earth*, September/October 2015, p. 70-77, [www.earthmagazine.org](http://www.earthmagazine.org)



- Response to Iben Browning's prediction of a 1990 New Madrid, Missouri, earthquake. USGS Circular 1083, 248 p. Stein, R. S. 2003. Earthquake conversations. Scientific American, v. 288, no. 1, p. 72-79.
- Vere-Jones, D., D. Harte, and M. J. Kozuch. 1988. Operational requirements for an earthquake forecasting programme for New Zealand. Bulletin of the New Zealand Society for Earthquake Engineering, v. 31, no. 3, p. 194-205.
- Whiteside, L. S. 1998. Earthquake prediction is possible. Seismological Research Letters, v. 69, p. 287-88.
- Working Group on California Earthquake Probabilities. 1999. Earthquake probabilities in the San Francisco Bay Region: 2000 to 2030—a summary of findings. USGS Circular 1189 and <http://quake.usgs.gov/study/wg99/of99-517/index.html>
- Yeats, R.S., 2001, Living with Earthquakes in California: A Survivor's Guide. Oregon State University Press, 406 p.
- Youngs, R. R., et al. 2003. A methodology for probabilistic fault displacement hazard analysis (PFDHA). Earthquake Spectra, v. 19, p. 191-219.



## PART III

# PART III: SHAKY GROUND AND BIG WAVES

## Introduction

Up to this point, we have discussed *earthquake sources*: where earthquakes are likely to strike, how large they might be, and how often they might be expected. From the preceding chapter, you might conclude that we are not very far along in our ability to forecast the time when an earthquake might occur, although we have devised some fairly elaborate statistical procedures to describe our uncertainty.

It is also important to describe the geologic setting *at the Earth's surface*, in particular the response of the ground to an earthquake. Most of us are concerned less about the strength of the earthquake itself than we are about its effects where we are at the time, or where we live, or own property, or work. As has been said about politics, all earthquakes are local.

I am continually amazed at the apparently random damage of a major earthquake. The Nisqually

Earthquake, with its epicenter close to Olympia, did major damage in Seattle, but Tacoma, much closer to the epicenter, got off fairly easily. After the 1994 Northridge Earthquake, I visited the Fashion Square Mall, in which several major stores and a large parking garage were demolished. Nearby, other shopping malls had hardly been damaged at all. This was not necessarily due to the distance from the epicenter of the earthquake. Interstate 10, connecting Santa Monica and downtown Los Angeles, on the south side of the Santa Monica Mountains and far from the Northridge epicenter, suffered severe damage, including the collapse of a major interchange. But condominiums and houses perched high in the Santa Monica Mountains, closer to the epicenter, were not severely damaged.

We have now come to recognize certain geologic settings where built structures are likely to suffer much more earthquake damage than others. Liquefaction maps of Seattle and Olympia were prepared prior to the 2001 Nisqually Earthquake, and liquefaction tended to be limited to those areas where those maps predicted it would occur. The Oregon Department of Geology and Mineral Industries has published maps of Portland, Salem, and Eugene locating the more hazardous environments with respect to construction. Similar maps have been prepared for Victoria, B. C. Although no two earthquakes will produce the same damage pattern in a given region, certain sites can be recognized as hazardous in advance of decisions to develop them.

Some of the greatest losses of life and property result

from the dislodging of great masses of earth as landslides and rockfalls. These are not the normal mudslides that plague the Pacific Northwest in a rainy winter. In some cases, they are much larger volumes of rock and soil that would not move even during very heavy rainfall.

For example, a M 7.9 earthquake on the subduction zone off the coast of Peru on May 31, 1970, caused a slab of rock and ice hundreds of feet across to break off a near-vertical cliff high on Mt. Huascarán, the highest mountain in Peru. The mass of rock and ice fell several thousand feet, disintegrated, slid across a glacier, then overtopped low ridges below the glacier and became airborne. After falling back to the ground, the rock mass swept down the valley of the Shacsha River, entraining the water of the river as it did so. This flow of mixed debris and water reached velocities of one hundred and twenty miles per hour. Seven miles from its source, this rapidly moving mass separated into two streams of debris, one of which rode over a ridge and buried the town of Yungay. The other stream of debris obliterated the city of Ranrahirca. Nearly 80,000 people lost their lives in this single landslide, the greatest recorded natural disaster in the Western Hemisphere prior to the Port-au-Prince earthquake of January 2010. Most of the residents of these overwhelmed cities died instantly, without warning. The entire time from first collapse high on Huascarán to destruction of these cities was less than four minutes!

Closer to home, the Oso landslide in March, 2014 in

Snohomish County, Washington, on the western slope of the Cascades, killed 43 people and was categorized as a national disaster emergency. The area had previously been determined to be a landslide hazard— a previous landslide had been described by the USGS in 2006. Yet local government took no responsibility for warning people about the hazard, and in fact not only allowed additional houses to be built in the landslide area, but also permitted logging that further destabilized the slope.

But landslide danger is not limited to steep slopes. Nearly flat areas underlain by clean, water-saturated sand may fail by liquefaction of the sand, which bursts to the surface as fountains and causes the land itself to move like a gigantic snowboard, snapping utility lines. During the Northridge Earthquake, a mass of land along Balboa Boulevard slid along a very gentle slope, rupturing a buried water line and a gas line. Escaping gas led to a fire that destroyed many homes in the vicinity. Television newscasts showed the odd combination of flames leaping above the roadway combined with torrents of water from the ruptured water line.

People living on the coast face another hazard: *tsunamis*. Tsunamis have produced catastrophic losses of life in the tens of thousands. The earthquake generating a tsunami may be thousands of miles away, across the ocean. The Pacific Northwest had its own deadly tsunami on the Easter weekend of 1964, after the great Alaskan earthquake.

One of the main reasons our risk is increasing is that we are building in increasingly unstable and dangerous areas. The demand for housing has expanded urban development into river floodplains like the Duwamish River in Seattle, steep hillslopes like Salmon Beach in Tacoma, and sandbars such as Seaside on the Oregon coast. These environments pose hazards other than earthquakes, as shown in the drowned-out homes in the floods of February 1996, and in the recent mudslides of Portland and Puget Sound, all unrelated to earthquakes.

I was astounded to read an Associated Press article on December 23, 1996, stating that the demand for building sites in the Portland metropolitan area is so strong that builders hire professional scouts to look for owners of undeveloped land who might be persuaded to sell, if not now, perhaps two or three years in the future. Land hunters may call up a title company and request information on any land parcel two acres or larger in a particular area. Armed with that information, they start calling landowners. Some land in Washington County, Oregon, is reported to be selling for more than \$150,000 an acre.

The article did not mention that some of these building sites around Portland, as well as Seattle and other cities in the Northwest, are dangerously flawed by their geology, with possibilities of landslides, flooding, earthquake shaking, and liquefaction. I know of no automatic legal provision that a potential homeowner in these newly developed subdivisions (as

well as in neighborhoods long since built up) must be fully informed of these geologic hazards before purchasing a lot or a home. I recall the Keizer, Oregon, homeowner who had lived in his new house only a few months when he was flooded out by the Willamette River in February 1996. Said he on the TV evening news: “The county said it was OK.” Neither the landowner, who may get more than \$100,000 an acre for the family farm, nor the developer wants to be the one to enlighten the unwary buyer.

California now has legislation that requires inspection of building sites with respect to earthquake hazards as well as other geologic hazards. Protection of this sort is available in Washington and Oregon only in a few communities such as Seattle and King County, where grading ordinances have been passed.

In all these cases, it is possible to assess the geologic hazards to construction and, in most cases, to “engineer” around them, although strengthening a building site against earthquakes increases the cost of development. The person building on a particular site (or moving to an already-built house on such a site) must weigh the risk of an unlikely but potentially catastrophic earthquake against the possibility that the house could remain safe for a lifetime. In the two chapters that follow, I consider these hazards and conclude that we know quite a lot about predicting *how* a particular site will respond, even though we do not know *when* the earthquake will strike that will put the site and the people living and working there at



risk. We know enough that we could put teeth into laws requiring that a buyer be made aware of geologic hazards before investing in a piece of property. We could make sure that local grading ordinances require inspection of building sites against possible geologic hazards, in addition to inspection of the building itself. I will return to such ordinances in Chapter 14.



# 8. Solid Rock and Bowls of Jello

*“Anyone who hears my words and puts them into practice is like the wise man who built his house on rock. When the rainy season set in, the torrents came and the winds blew and buffeted his house. It did not collapse; it had been solidly set on rock. Anyone who hears my words but does not put them into practice is like the foolish man who built his house on sandy ground. The rains fell, the torrents came, the winds blew and lashed against his house. It collapsed under all this and was completely ruined.”*

Book of Matthew 7:24-27

## I. Introduction

We live in earthquake country, but we don't want to leave the Pacific Northwest. Fortunately, we know how to improve our chances for survival simply by making intelligent decisions about where we live or work and how we build. The technology is at hand to evaluate

the geologic setting of a building site with respect to earthquake hazard.

Three different earthquake problems are associated with surface sites: (1) amplification of seismic waves by soft surficial deposits, (2) liquefaction of near-surface sediments, and (3) failure of hillslopes by landslides, rockfalls, and debris flows.

## 2. Amplification of Seismic Waves by Soft Surficial Deposits

It is a short stroll from Fort Mason, west of Ghirardelli Square and Fisherman's Wharf in San Francisco, to the fashionable townhouses of the upscale Marina District, yet the intensity of ground motion of these two areas during the earthquake of October 17, 1989, was dramatically different. The Marina District experienced intensities as high as IX, higher even than at the epicenter itself, more than sixty miles away. Fort Mason and Fisherman's Wharf experienced intensities of only VII.

On April 18, 1906, Fort Mason was under the command of Captain M. L. Walker of the U.S. Army Corps of Engineers. The great San Francisco Earthquake had shaken Captain Walker awake, but he had then gone back to bed, thinking that the earthquake was "no more than a mild shaker." Brigadier

General Frederick Funston, on Sansome Street in the maelstrom of collapsed buildings and towering fires, sent Captain Walker an urgent summons to muster his company of troops. The captain had to be roused a second time.

Why was Fort Mason spared the worst of both earthquakes? Fort Mason is built on bedrock, and the Marina District that was damaged in 1989 is built on soft sediment. The geologic foundation material made all the difference.

The Marina District was built on fine sand from San Francisco Bay, “made land” that was hydraulically emplaced after the 1906 earthquake, together with rubble from buildings destroyed by that earthquake. This material was pushed together to make a building site for an international exposition in 1915 that said to the world, “San Francisco is back!” Yes, San Francisco was back, all right, but the sand and rubble contained a time bomb: the foundation was too poorly consolidated to hold up well during the next earthquake. In October 1989, the time bomb went off.

Figure 8-1 shows seismograms of an aftershock of magnitude 4.6 on October 21 recorded at Fort Mason (MAS), where the seismograph was established on bedrock, and two sites in the Marina District, one (PUC) on dune sand from an ancient beach, and the other (LMS) on the artificial fill emplaced after the 1906 earthquake. The seismic waves were much stronger at PUC and LMS than at MAS, an indication of more violent seismic shaking, leading to more damage. The

waves were also of much lower frequency. Engineers call a station like MAS a rock site, and stations like PUC and LMS soil sites.

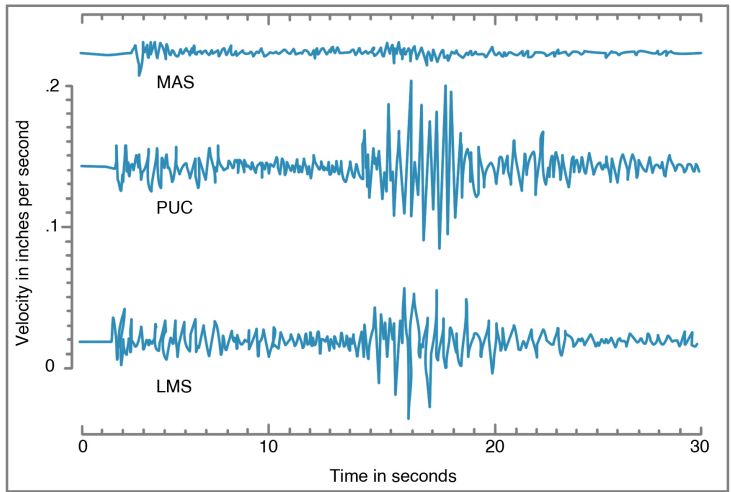

Figure 8-1. Seismograms of a magnitude 4.6 aftershock of the Loma Prieta earthquake on October 21, 1989, at three temporary stations at the north end of San Francisco Peninsula, showing amplification of ground motion in two soil sites in the Marina district (PUC, LMS) compared to a bedrock site at Fort Mason (MAS). From USGS

An analogy is commonly made between these two types of site and a bowl of jello on a table, an experiment that can be done at home. Stack two or three children's blocks on top of one another on the table top, then stack some more blocks on top of the jello. Then jolt the table sideways. The blocks on the jello will fall over, whereas the blocks directly on the table top might

remain standing. The shaking of the blocks on the table illustrates the effect of a seismic wave passing through bedrock. When the shaking reaches the bowl of jello, however, the waves are amplified so that the top of the jello jiggles and causes the blocks to topple. In a similar fashion, the soft foundation materials at a soil site will amplify the seismic waves, which results in much more vigorous shaking than would be expected at a rock site.

A tragic illustration of this phenomenon was provided by the magnitude 8.1 Mexico City Earthquake of 1985. Actually, the epicenter of the earthquake was in the Pacific Ocean on a subduction zone, hundreds of miles from Mexico City. It is called the Mexico City Earthquake because of the terrible losses suffered by that city. More than fifteen million people live in Mexico City, many in substandard housing, which was one reason why so many lives were lost. But more important is the geologic foundation: Mexico City is built on the former bed of Lake Texcoco. The clay, silt, and sand of this ancient lake, in part saturated with water, greatly amplified the seismic waves traveling from the subduction zone. More than five hundred buildings fell down, and more than ten thousand people were killed. The floor of Lake Texcoco truly acted like the bowl of jello resting on the table top that is the Earth's crust beneath the lake deposits.

The Mexico City Earthquake provided a lesson for the major cities of the Willamette Valley, Puget Sound, and the Fraser River delta in southwestern British Columbia. Much of the foundation of these cities is soft

sediment: deltaic deposits of the Fraser and Duwamish rivers, glacial deposits in Puget Sound, and alluvial deposits of the Willamette and Columbia rivers. Even though a subduction-zone earthquake would be far away, near the coast or offshore (as it was for Mexico City), these soft sediments would be expected to amplify the seismic waves and cause more damage than if the cities were built on bedrock. Fortunately for the people of the Pacific Northwest, building standards are higher than those in Mexico City in 1985, so we would not expect as high a loss of life. In addition, geotechnical experience with many earthquakes around the world permits a forecast of the effects of near-surface geology on seismic waves from various earthquake sources. In other words, this is a problem we can do something about.

These techniques are illustrated by a study led by Ivan Wong, then of Woodward-Clyde Federal Services, in cooperation with the Oregon Department of Geology and Mineral Industries for the City of Portland. Because no two earthquake sources are alike, Wong and his colleagues programmed computer simulations based on a Cascadia Subduction Zone earthquake of  $M_w$  8.5 and crustal earthquakes of  $M_w$  6 and  $M_w$  6.5. Because the surface effects are strongly influenced (attenuated) by the distance of a site from the epicenter, they used distances from the crustal source to the site of five, ten, and fifteen kilometers (1.6 kilometers = one mile).

What property of a seismic wave is best for determining the hazard to buildings? Wong's group



used *peak horizontal acceleration*, expressed in *percentage of gravity (percent g)*. Acceleration is the rate of increase in speed of an object. If you step off a cliff and fall through space, your speed will accelerate from zero at a rate of 32 feet (9.8 meters) per second every second, due to the gravitational attraction of the Earth. This is an acceleration of 1 g. When an earthquake has a vertical acceleration greater than 1 g, stones or clods of earth are thrown into the air, as first observed during a great earthquake in India in 1897. Vertical accelerations greater than 1 g were recorded during the 1971 San Fernando, California, Earthquake, with the result that a fire truck with its brakes set was tossed about the Lopez Canyon Fire Station, leaving tire marks on the garage door frame 3 feet above the floor.

Horizontal accelerations may be measured as well. A car accelerating at a rate of 1 g would travel 100 yards from a stationary position in slightly more than 4 seconds. As we will see later, horizontal accelerations are particularly critical, because many older buildings constructed without consideration of earthquakes are designed to withstand vertical loads, such as the weight of the building itself, whereas an earthquake may cause a building to shake from side to side, accelerating horizontally. A higher peak acceleration will lead to a higher earthquake intensity at a given site.

Other properties of strong ground motions that relate to damage are *velocity*—how fast a building shakes back and forth during an earthquake—and *displacement*—how far the seismic wave causes the

ground to move from side to side. In general, the higher the acceleration, the higher the velocity and displacement. However, it does not follow that the higher the magnitude of the earthquake, the higher the acceleration. Some of the highest accelerations ever recorded occurred during earthquakes of magnitude less than 7. The Yountville Earthquake of September 3, 2000, in northern California, had a magnitude of only M 5.2, yet it resulted in accelerations up to 0.5 g.

Strong shaking is measured by a special type of seismograph called a *strong-motion accelerometer*. These instruments are necessary because an ordinary continuous-recording seismograph may go off scale during a strong earthquake. The strong-motion instrument does not record continuously, but is triggered to start recording when the first large earthquake wave arrives, and it stops recording when the waves diminish to a low level. These instruments record the acceleration in percent g; other instruments record velocity or displacement. These records are of particular use to structural engineers, who use them to determine how buildings vibrate during an earthquake. Several instruments may be placed in a single tall building, one in the basement and others on upper floors, showing very different response to shaking of different levels of the building. It is prudent to install strong-motion accelerometers in all major structures such as dams or skyscrapers. The installation cost is very small compared to the cost of the building, and the

information revealed during an earthquake is invaluable for future engineering design.

Another consideration is the period of the earthquake waves that are potentially damaging. *Period* is the length of time it takes one wave length to pass a given point (Figure 3-12). We have already encountered *frequency*, the number of wave lengths to pass a point in a second. Frequency is equal to 1 divided by the period. As we saw in Chapter 3, earthquakes, like symphony orchestras, produce waves of short period and high frequency (piccolos and violins) and waves of long period and low frequency (tubas and bass violins).

Wong and his colleagues considered the effects on four sites in Portland, Oregon, of a spectrum of waves from high frequency with periods of 0.02 seconds to low frequency with periods of 10 seconds (Figure 8-2). The computer model of their earthquake included the slip on the assumed earthquake fault and the effect of near-surface geology. They drilled boreholes and measured the density (weight per given volume) of the various sedimentary layers they encountered as well as the speed of sound waves passing through the sediments. Soft sediment such as sand or clay is low in density, whereas bedrock such as basalt has a high density. Sound waves (and earthquake waves) pass slowly through soft sediment, and much more rapidly through bedrock.

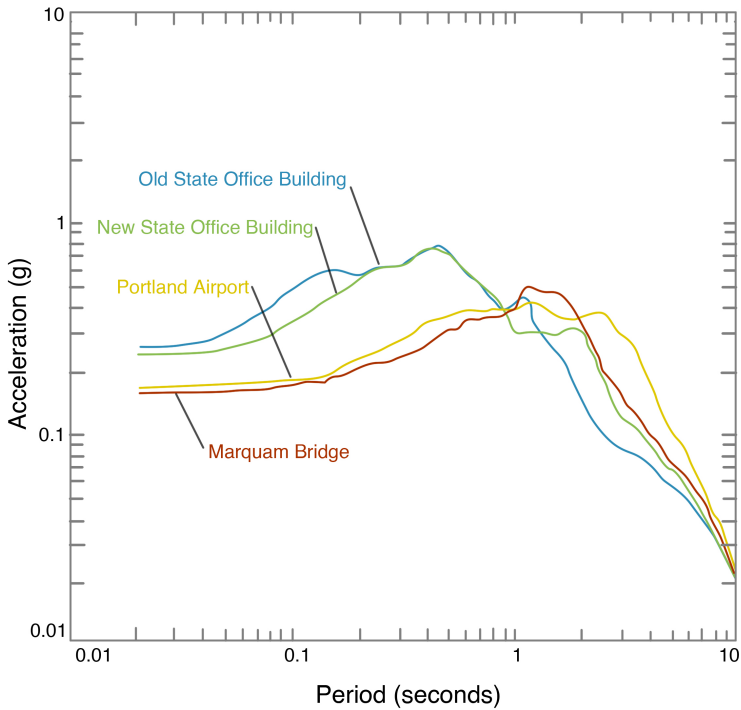

Figure 8-2. Acceleration, in percent gravity (g) of seismic waves of different periods from a postulated Cascadia Subduction Zone earthquake at four soil sites in Portland. Earthquake is 120 km from Portland. From Wong et al. (1993)

As the seismic waves pass from bedrock to soft sediment, they slow down and increase in amplitude. The increase in amplitude causes greater acceleration of the ground at a particular site, which leads to more intense shaking. For these reasons, the thickness and density of the soft sediment layers directly beneath the

surface are critical to the calculation of shaking and potential damage.

Figure 8-2 shows an example of some of their calculations, in this case for a Cascadia Subduction Zone earthquake. These are logarithmic curves; each division has a value ten times that of the previous one. The curves show that the greatest accelerations are expected for seismic waves with periods ranging from 0.4 to 2 seconds. Different sets of curves were obtained for the crustal earthquakes. There is considerable difference in the curves among the four sites, emphasizing the importance of understanding the near-surface geology.

Another factor important in constructing these curves is the *attenuation* of seismic waves between the earthquake focus and the site in question. Attenuation is affected by the strength and rigidity of the crust through which the seismic wave must pass. Imagine putting your ear against the cut surface of a long log which is struck on the other end by a hammer. If the log is made of sound wood, the vibration caused by the hammer may be enough to hurt your ear. The attenuation of the wave in the log is low. However, if the log is made of rotten wood, you may hear a dull “thunk,” indicating that the attenuation is high. In the crust, high attenuation means that the strength of the earthquake wave falls off fairly rapidly with distance from the focus.

In the discussion above, we have been concerned about the effect on earthquake shaking of the geology at or near the surface of the ground. Recent research

in California has shown that the *path* traveled by an earthquake from the source to the surface also can have a dramatic effect on shaking. Kim Olsen and Ralph Archuleta of the University of California at Santa Barbara constructed elaborate computer models of the effects of a M 7.75 earthquake on the San Andreas Fault on shaking in the Los Angeles Basin, thirty to forty miles away. The Los Angeles Basin is filled to depths of four to six miles with sedimentary rocks that have a much lower density than crustal rocks beneath the basin or in the adjacent mountain ranges. Olsen and Archuleta showed that their simulated earthquake would generate surface waves that would slow down and increase dramatically in amplitude as they entered the Los Angeles Basin. In addition, the surface waves would bounce off the base and the steep sides of the sedimentary basin, so that strong shaking would last much longer than it would at the source of the earthquake.

This effect could also be felt in sedimentary basins that are much shallower than the Los Angeles Basin. These include the Tualatin Basin in Oregon, with the cities of Beaverton, Hillsboro, and Forest Grove, the Portland-Vancouver Basin in Oregon and Washington between downtown Portland and Troutdale, and the Seattle Basin in Washington between downtown Seattle and Everett. After the Nisqually Earthquake of 2001, Derek Booth of the University of Washington surveyed sixty thousand chimneys for damage and found that chimney damage was concentrated in West Seattle,

Bremerton, and other areas close to the Seattle Fault. West Seattle was also hit hard in the 1965 Seattle Earthquake. The boundary between bedrock on the south and soft sediments on the north is abrupt and steep, and Booth suggested that earthquake waves might have been focused to produce greater damage along a line parallel to the fault. The fault zone might contain highly fractured ground-up rock, giving it a lower speed for seismic waves than unfaulted rock on either side. This low-velocity zone might also focus earthquake waves and increase the damage.



Figure 8-3. Map of the Pacific Northwest showing earthquake horizontal accelerations having a 10 percent probability of being exceeded in fifty years for a firm rock site (Soil Class B site in Canada). Contours in percent gravity (g). From USGS and Geological Survey of Canada (Basham et al., 1997). USGS map revised in 2002

This idea was also tested in the Fraser River Delta around Vancouver, B. C., by studying several strong-motion accelerometers that were triggered by a M 5.3 earthquake at Duvall, Washington, in 1996. The shaking recorded by accelerometers in the delta was stronger than shaking on bedrock sites, as expected, but the strongest shaking was found near the edge of the basin underlying the delta, perhaps due to focusing of seismic energy.

This behavior, related to the path the earthquake wave takes from the source to the site, could be considered a large-scale example of the bowl of jello. In both cases, surface waves are amplified, but in the examples of Los Angeles, the Seattle Fault, and the Fraser River Delta, the shaking is related to the path of the earthquake wave through a thick sedimentary basin, like focusing light through a lens.

The USGS and the Geological Survey of Canada have



combined all of these factors to produce maps showing peak horizontal accelerations over the next fifty years. One of these maps, revised in October 2002, is shown as Figure 8-3. The highest accelerations are forecast along the coast, closest to the subduction zone, with the highest values in northern California, which has the highest seismicity in the Northwest. However, other structures, particularly those that have ruptured historically, also affect the predicted accelerations. The 30 percent g contour curves east to include the Puget Sound region to take into account the slab earthquakes that have done so much damage there.

This map is probabilistic, but it estimates probability of acceleration, not magnitude, because acceleration is the value that is of most importance to engineers in evaluating seismic hazard and designing building codes. For example, the Seattle-Tacoma area has a 10 percent probability that an acceleration close to 30 percent g will be exceeded in the next fifty years. This acceleration will produce intensities of VII-VIII, which did major damage in the earthquakes of 1949, 1965, and 2001. The building you are constructing is likely to have a lifetime of at least fifty years. If there is one chance out of ten that the building will be subjected to these accelerations, doesn't it make sense to design the building accordingly?

### 3. Liquefaction: When the Earth Turns

## to Soup

Robert D. Norris of the USGS was driving on Harbor Island in the industrial area of Seattle when the Nisqually Earthquake hit. His truck was yawing from side to side, and he stopped to watch a dozen giant cargo cranes quivering and flexing, like nodding giraffes trying to dance. What followed next was reported by him in *Washington Geology*:

I was distracted by a wet swishing sound coming from the ground nearby. I looked over to its source and saw a smooth dome of brown fluid, perhaps half a meter ... wide and high, issuing from the ground. ... This dome lasted perhaps two seconds, then grew and burst into a muddy geyser. The geyser issued three or four very fluid splashes over the next few seconds ... then it widened and collapsed into a column about a half meter wide that discharged a tremendous volume of muddy water. The fluid emerged much faster than it could spread, so that within a few seconds the flow front had become a surge several centimeters high, like a small wave traveling up a dry beach. Its velocity was nearly one meter (yard) per second as far as I could tell. Within an estimated 30 seconds, the surge had grown into a shallow rotating pool

about six or seven meters ... across with bits of suds floating on it, still vigorously fed by the column of water at the original breakout site. ... The feeder column began to gradually wane after a couple of minutes. I ... was surprised to find the water was relatively clear; I could see to a depth of several centimeters in the pond.

Soft, unconsolidated sand deposits saturated with water can change from a solid to a liquid when shaken. You can observe this property in wet beach sand. Just tap-tap-tap your foot on the saturated sand at the water's edge. The sand will first start to bubble and eject a mixture of sand and water. Then the saturated sand from which the bubbles are emanating will flow downslope toward the sea.

Liquefaction is defined as “the act or process transforming any substance into a liquid.” If you have the misfortune of building a house on liquefiable sediment, and an earthquake strikes, your house might sink into the ground at a crazy angle as the sediment liquefies and turns into quicksand. Liquefaction is especially common in clean, loose sand, or gravelly sand saturated with water. Most sand layers with liquefaction potential are Holocene in age (less than ten thousand years old) and are unconsolidated.



*Figure 8-4. Sand blows caused by the Nisqually Earthquake from an east-west-striking crack in soft sediments in the Nisqually National Wildlife Refuge in the Nisqually River delta east of Olympia. The ejected sediments include ash from Mount Rainier. Marker pen for scale is 5.3 inches long. Photo by Pat Pringle, Washington Division of Geology and Earth Resources*

Sands that are subject to liquefaction are almost always buried to depths of less than thirty feet. At greater depths, the burial pressure is high enough to compact the sand and prevent liquefaction from taking place, unless the shaking is extremely severe. When earthquake waves shake the sand, the pressure of the waves deforms and compresses the sand for an instant, raising the water pressure in the pore spaces between

sand grains, thereby turning the sand-water mixture into a liquid. This temporary overpressuring (*cyclic shear stress* or *cyclic loading*) is repeated as long as strong shaking takes place. Such sand is generally overlain by a more cohesive material such as clay, soil, or pavement, which serves to confine the compressed water in the sand. If the sediment layer is on a slight slope, it will move downslope *en masse*; this is called a *lateral spread*. A lateral spread can move down a slope as low as 0.2 percent, which would hardly appear as a slope at all.

Perhaps the most spectacular expression of liquefaction, as observed by Norris on Harbor Island, occurs when watery sand vents to the surface through a clay cap or pavement, where it can spout up in the air like a fountain or geyser for minutes to hours after the main shock, leaving a low crater or mound (*sand boil*) after the fountain has died down (Figure 8-4). Excavation of sand boils by a backhoe or bulldozer reveals a vertical filling of sand within the clay cap, called a *sand dike* (Figure 8-5). The sand dike marks the place where sand at depth has vented to the surface. The presence of sand dikes in sediments, for example those found in an excavation beneath the Oregon Convention Center in Portland, is used as evidence for prehistoric earthquakes, although an alternate hypothesis holds that the sand dikes are related to the Missoula Floods of latest Pleistocene age.

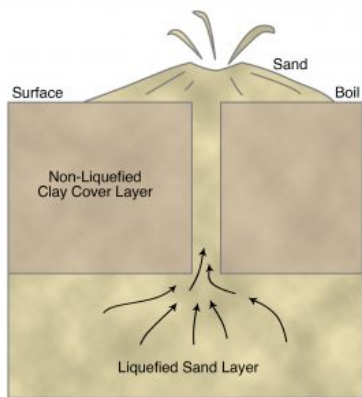

Figure 8-5. Vertical cross section through a sand boil, showing the liquefied sand layer, nonliquefiable clay cap, and the sand dike transmitting the liquefied sand to the surface, forming a sand boil or sand volcano. From Steve Obermeier, USGS

The liquefaction susceptibility of sand can be determined by standard geotechnical engineering tests such as the Standard Penetration Test. During this test, a sampling tube is driven into the ground by dropping a 140-pound weight from a height of thirty inches (okay, it isn't rocket science, but it works because every foundation engineer does it exactly the same way).

The penetration resistance is the number of blows (number of times the weight is dropped) it takes to drive the sampler one foot into the soil. A low penetration resistance would be fewer than ten blows per foot; a high resistance would be greater than thirty blows per foot. Liquefiable sands have a very low penetration resistance; it's very easy to drive the sampling tube into the sand.

Liquefaction can be triggered by earthquake accelerations as low as 0.1g. It has been observed with earthquakes with magnitudes as low as 5, and it becomes relatively common with larger magnitudes. Liquefaction is more extensive with a longer duration

of shaking, which is itself related to large moment magnitude.

Much of the severe damage in the Marina District of San Francisco during the 1989 earthquake was due to liquefaction of the artificial fill that had been emplaced after the 1906 earthquake. Sand boils erupted into townhouse basements, streets, yards, and parks. Lateral spreading of the ground surface broke underground utility lines, leaving about a thousand homes without gas or water. The gas was not shut off, and the broken gas lines caused large fires to break out.

Liquefaction of beach deposits during the 1989 earthquake severely damaged the San Jose State University Marine Laboratory at Moss Landing (Figure 8-6). This illustrates the problem for cities like Seaside, Oregon, and Long Beach, Washington, built on sand bars.



*Figure 8-6. Tilted buildings at San Jose State University Marine Laboratory at Moss Landing, California, due to liquefaction of beach deposits during the October 1989 Loma Prieta Earthquake. Photo by G. W. Wilson, USGS*

Liquefaction during the Good Friday Earthquake of 1964 in Alaska destroyed part of the new Turnagain Heights subdivision of Anchorage, situated on a thirty-foot bluff overlooking Cook Inlet (Figure 8-7). Earthquake waves liquefied a layer of sand and clay, causing part of the subdivision to break up and slide toward the bay. Homes, patios, streets, and trees tilted at weird angles, and gaping chasms opened, swallowing up and burying alive two small children. One house slid more than twelve hundred feet toward the sea, destroying itself as it did so. The instability of the water-saturated layer within the Bootlegger Cove Clay had been pointed out



in a report by the USGS in 1959, five years before the earthquake, but this information evidently had no influence on development plans for Turnagain Heights.



*Figure 8-7. Destruction of part of Turnagain Heights subdivision of the city of Anchorage by liquefaction of a sand layer in the Bootlegger Clay accompanying the Good Friday 1964 Earthquake in the Gulf of Alaska. The ground and the houses were disrupted; note the tilted trees. Photo by George Plafker, USGS*

During the Puget Sound earthquakes of 1949 and 1965, 25 percent of the damage may have been caused by liquefaction. Drawbridges across the Duwamish Waterway in Seattle were disabled during both earthquakes. The distance between the piers in the main span of the Spokane Street Bridge was shortened by six to eight inches due to a lateral spread, jamming

the drawbridge in the closed position. Geysers of sandy water were reported in 1949 at Longview, Centralia, Puyallup, and Seattle, and a large part of a sandy spit jutting into Puget Sound north of Olympia disappeared in 1949, probably due to liquefaction of the sand. Sediments beneath a mobile home park at Tumwater, Washington, liquefied during the Nisqually Earthquake, as they had in the earlier 1949 and 1965 earthquakes (Figure 8-8). Severe liquefaction also occurred in the delta of the Nisqually River east of Olympia (Figure 8-4), but much of that area is a wildlife refuge, an appropriate use for this unstable ground.



*Figure 8-8. Lateral spread at Sunset Lake, Tumwater Memorial Mobile Home Park near Tumwater, Washington. Photo by Steven Kramer, University of Washington.*

One of the arguments raised against a seismic origin of the buried marsh deposits on the Pacific coast is the rarity of liquefaction features such as sand dikes. However, many of these marshes are not underlain by clean sand. Pleistocene beach sand may underlie the Holocene marsh sequences, but if so, it is probably too consolidated and too deeply buried to undergo liquefaction.

On the other hand, liquefaction features are common on low islands in the tidal reaches of the Columbia River between Astoria, Oregon, and Kalama, Washington (Figure 8-9). These islands are flat, poorly drained, and swampy, and large parts of them are submerged during very high tides. Steve Obermeier of the USGS examined steep banks sculpted by the river and found that the islands are composed mainly of soft clay-rich silt, locally containing volcanic ash layers from Mt. St. Helens. Radiocarbon dating and correlation of the ash to a dated Mt. St. Helens ash indicate that the silt is less than one thousand years old.

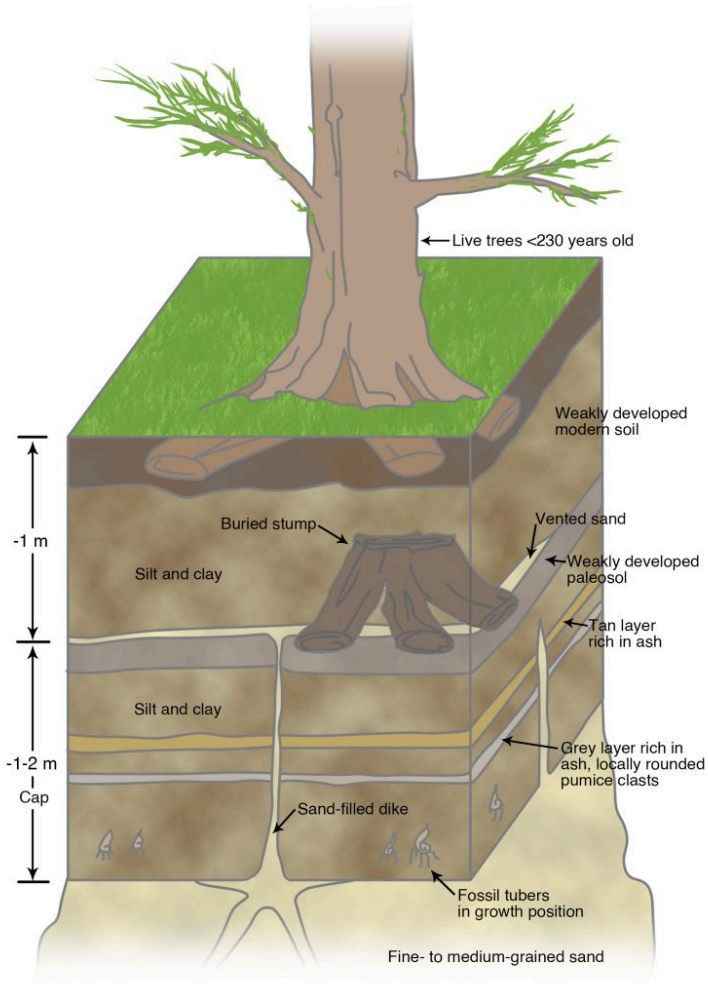

Figure 8-9. Block diagram showing field relations at liquefaction sites on islands in the lower Columbia River. Sand-filled dike cuts through silt and clay with a poorly developed soil at top. Dike connects to thin sand sheet on top of soil that may be remains of sand boil. Tubers have radiocarbon ages of six hundred to one thousand years. Silt and clay on top of sand sheet is younger than dike emplacement; oldest living trees are less than 230 years old. (1 m = just over 3 feet 3 inches). From Steve Obermeier, USGS

The silt layers are cut by hundreds of sand dikes (Figure 8-9), widest on islands near Astoria, and progressively narrower on islands upriver. These sand dikes were emplaced prior to the oldest trees now found on the islands, which are less than two hundred and thirty years old based on tree-ring dating. For this reason, Obermeier suggests that the dikes were probably emplaced during the great Cascadia Subduction Zone Earthquake of A.D. 1700. The dikes are present in the islands of the Columbia River because a source of river sand may lie just below the silt layer.

Curt Peterson of Portland State University has found that the late Pleistocene marine terrace deposits of the coast between central Washington and northern California contain abundant dikes, some as thick as three feet, evidence for strong earthquake shaking. The source for these dikes is the beach sand marking the base of the terrace. As stated earlier, nearly all examples of liquefaction during historical and late Holocene times involve sand sources that are Holocene in age, not Pleistocene. The sand dikes in the Pleistocene terrace deposits must have been generated by Pleistocene subduction-zone earthquakes, slightly younger than the terrace material in which they are found.

The potential for liquefaction can be reduced by various foundation-engineering techniques to strengthen the soil. These techniques include driving deep piles or piers through the liquefiable layer, emplacing concrete grout through weak layers, or even

replacing liquefiable sediments with earth materials not subject to liquefaction. Sloping areas with a potential for lateral spread can be buttressed in the downslope direction. Such solutions are expensive, but they were shown to work during the Loma Prieta Earthquake of 1989. The Marina District suffered greatly from liquefaction, but sites in the San Francisco Bay Area that had received foundation-engineering treatment, including Treasure Island, Emeryville, Richmond, Union City, and South San Francisco, had little or no damage to the ground or to structures.

## 4. Landslides Generated by Earthquakes

Liquefaction tends to be most pronounced in low, flat areas underlain by Holocene deposits. But in earthquake country, it does not help to escape to the hills. Most of the thousands of landslides generated during a major earthquake are small, but some are very large, as described previously for the 1970 earthquake in Peru.

On July 10, 1958, as reported by George Plafker of USGS, an earthquake of M 7.9 on the Fairweather Fault, Alaska, triggered a landslide on the side of a mountain overlooking Lituya Bay, in Glacier Bay National Park. A great mass of soil and rock swept down the mountainside into the bay, crossed the bay, and had enough momentum to ride up the opposite side to a

height of nine hundred feet, denuding the forest cover as it did so. The slide created a huge water wave one hundred feet high that swept seaward, carrying three fishing boats over the sand spit at the mouth of the bay into the ocean. An earthquake of M 7.6 on August 18, 1959, in Montana, just north of Yellowstone National Park, triggered a landslide that swept down a mountainside and through a campground, burying a number of campers together with their tents and vehicles. The landslide crossed the Madison River with enough momentum that it continued up the other side of the valley, damming the river and creating a new lake.

Earthquakes less than M 5.5 generate dozens of landslides, and earthquakes greater than M 8 generate thousands. The Northridge Earthquake triggered more than eleven thousand landslides, mostly in the mountains adjacent to the epicenter. The Puget Sound earthquakes of 1949 and 1965 triggered many landslides, including one that dislodged a railroad track near Tumwater, Washington (Figure 8-10). Landslides are particularly common in heavily forested areas of the Northwest, triggered by rainfall and by earthquakes.



*Figure 8-10. Hillside slid away from beneath this four-hundred-foot section of a Union Pacific Railway branch line at Tumwater, near Olympia, Washington, during the Puget Sound Earthquake of 1965. A large landslide during the heavy-rainfall winter of 1996-97 also damaged the rail line. Photo by G.W. Thorsen, Washington Division of Geology and Earth Resources.*

Paula Vandorssen of Renton, Washington, had been on the telephone when the Nisqually Earthquake hit. She quickly became aware that a massive wall of earth was pressing against the side of her house. Within a matter of seconds, mud and debris filled her living room. Paula stumbled onto her front porch and rolled down the hill as the slide pushed her house sideways. It was not quite eleven o'clock; a few minutes later, her five-year-old daughter would have been home, playing on the side of the house smashed by the slide. Other parts of the slide



dammed the Cedar River (Figure 8-11), and more than one hundred families were evacuated as a lake began to form. Earth-moving equipment was quickly brought in to breach the mud dam.



*Figure 8-11. Landslide from the 2001 Nisqually earthquake near Cedar River. Landslide deposits in center of photo. Photo courtesy of King County, Washington.*

Salmon Beach lies along a bluff overlooking Puget Sound south of Point Defiance in Tacoma (Figure 8-12a, b). Its houses, with their magnificent views of the Sound and the Olympics, can be reached only by boat or by descending several hundred wooden steps from the road. The Nisqually Earthquake dislodged up to twenty thousand cubic feet of soil and debris; one large fir tree was pointed like a lance at the window of Luke and Alisa

Xitco's eighteen-month-old 4,600-square-foot cedar shake house. Eight houses were evacuated, several with serious damage. Luke Xitco declared that he was staying.



*Figure 8-12a. Landslide on steep bluffs overlooking Puget Sound at Salmon Beach, near Tacoma Narrows, a few days after the 1949 Puget Sound Earthquake. The landslide endangered several beach houses and produced high waves in the narrows. Landslides occurred at the same place during the 2001 Nisqually Earthquake. From Washington Division of Geology and Earth Resources.*



*Figure 8-12b. Salmon Beach landslide near Tacoma Narrows after the 2001 Nisqually earthquake. Houses overlooking Puget Sound have no road access; landslide struck behind the houses, as it did in 1949. Photo courtesy of Jon Bray, University of California Berkeley.*

The Nisqually earthquake was not the first to heavily damage the homes at Salmon Beach. Similar damage was experienced during the earthquake of 1949 (Figure 8-12a).

Fourteen homes on a bluff overlooking Puget Sound on Maplewood Avenue Southwest in Burien had to be evacuated (Figure 8-12b) after the Nisqually Earthquake when a foot-wide moat appeared between the road and the driveways. Other homes along the beach below

were also evacuated, though some residents stayed despite the evacuation order.

In addition to railroad damage (Figure 8-10), highways were also put out of service, as illustrated by Figure 8-13. Damage to highways caused delays in rescue operations and repair of damaged homes.



*Fig. 8-13. Landslide across Highway 101, about 100 feet across. Photo courtesy of Jon Bray, University of California Berkeley.*

Some of the most common landslide types are rockfalls and rockslides. Although rockfalls might have a nonseismic origin, Bob Schuster of the USGS found that large rockfalls damming lakes on the eastern Olympic Peninsula of Washington (Figure 6-7) were most likely formed during a large earthquake eleven hundred years

ago. No rockfalls as large as these are known from this area in historic time, which included earthquakes as large as M 7.1 as well as many severe winter storms.

Anyone who has hiked in the mountains has observed that many rocky talus slopes appear to be quite precarious, and seismic shaking can set these slopes in motion. John Muir, who experienced the 1872 Owens Valley Earthquake (M 7.7) in Yosemite Valley, described it best:

At half-past two o'clock of a moonlit morning in March, I was awakened by a tremendous earthquake, and though I had never before enjoyed a storm of this sort, the strange thrilling motion could not be mistaken, and I ran out of my cabin, both glad and frightened, shouting, "A noble earthquake! A noble earthquake!" feeling sure I was going to learn something. The shocks were so violent and varied, and succeeding one another so closely, that I had to balance myself carefully in walking as if on the deck of a ship among waves, and it seemed impossible that the high cliffs of the Valley could escape being shattered. In particular, I feared that the sheer-fronted Sentinel Rock, towering above my cabin, would be shaken down, and I took shelter back of a large yellow pine, hoping that it might protect me from at least the smaller outbounding boulders. For a minute or two the

shocks became more and more violent—flashing horizontal thrusts mixed with a few twists and battering, explosive, upheaving jolts,—as if Nature were wrecking her Yosemite temple, and getting ready to build a still better one.

I was now convinced before a single boulder had fallen that earthquakes were the talus-makers and positive proof soon came. It was a calm moonlight night, and no sound was heard for the first minute or so, save low, muffled, underground, bubbling rumblings, and the whispering and rustling of the agitated trees, as if Nature were holding her breath. Then, suddenly, out of the strange silence and strange motion there came a tremendous roar. The Eagle Rock on the south wall, about a half a mile up the Valley, gave way and I saw it falling in thousands of the great boulders I had so long been studying, pouring to the Valley floor in a free curve luminous from friction, making a terribly sublime spectacle—an arc of glowing, passionate fire, fifteen hundred feet span, as true in form and as serene in beauty as a rainbow in the midst of the stupendous, roaring rock-storm. The sound was so tremendously deep and broad and earnest, the whole earth like a living creature seemed to have at last found a voice and to be calling to her sister planets. In trying to tell something of the size of

this awful sound it seems to me that if all the thunder of all the storms I had ever heard were condensed into one roar it would not equal this rock-roar at the birth of a mountain talus.

The great landslides of Peru, Madison River, and Lituya Bay were rock avalanches, generally triggered by rockfalls at the time of the earthquake. Nearly all rockfalls are small, although locally damaging or deadly, like the one that killed Ken Campbell north of Klamath Falls, Oregon (Figure 6-24), and many have nonseismic origins like the Oso, Washington, landslide of March 2014. However, great rock avalanches seem to be unique to earthquakes, or earthquakes combined with volcanism, as in the huge avalanche that crashed into Spirit Lake and blocked the Toutle River during the Mt. St. Helens eruption of May 18, 1980. That avalanche was triggered by an earthquake of M 5.1, but both the avalanche and the earthquake might have been an effect of the eruption, which blew out the north side of the mountain.

Landslides on the sea floor are an increasingly recognized phenomenon, principally because of the availability of side-scan sonar and new methods to map the topography of the sea floor. The continental slope off southern Oregon is largely composed of huge landslides, including the one illustrated in Figure 8-14 off Florence, Oregon. Chris Goldfinger mapped a landslide at the base of the continental slope off central Washington in which individual mountain-size blocks

rode down onto the abyssal plain, leaving skid marks on the sea floor in their wake. These landslides are so large that it seems likely that they would generate huge sea waves, or tsunamis, as similar landslides have been shown to do on Hawaii and Papua New Guinea.



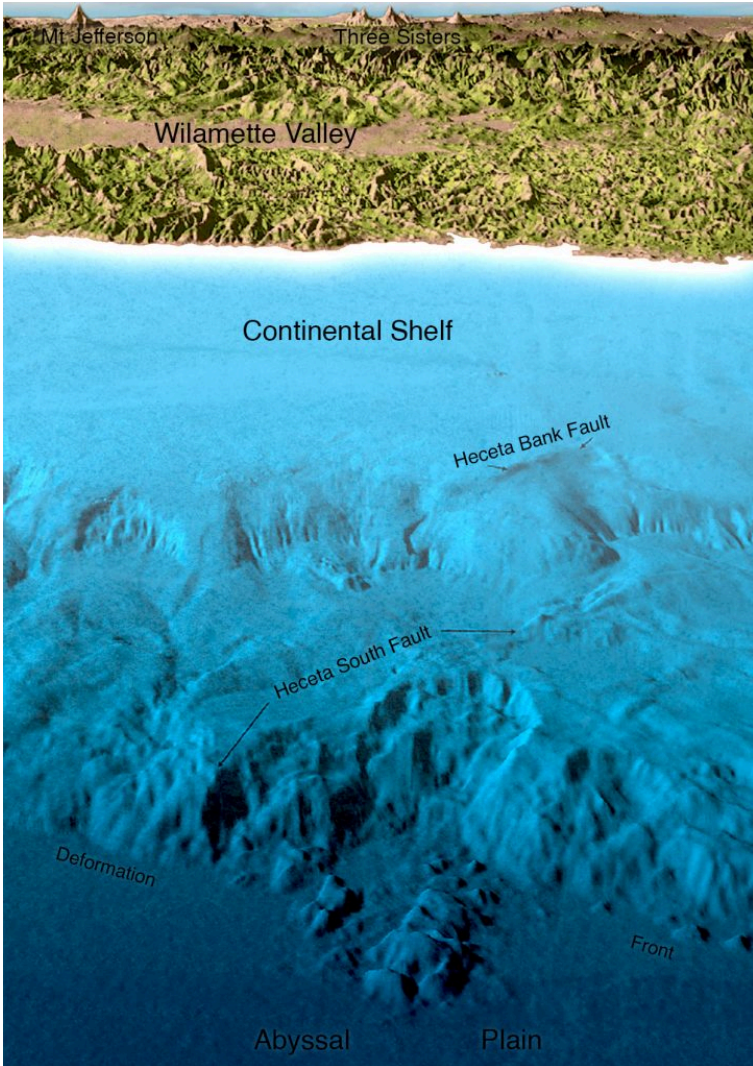

Figure 8-14. Large landslide at the base of the continental slope west of Florence, Oregon. Slide is five miles across; debris has been transported across the deformation front onto the Juan de Fuca abyssal plain. The active Heceta South Fault marks part of the northern side of the slide. Image created by Chris Goldfinger at Oregon State University from SeaBeam bathymetric maps of the National Oceanic and Atmospheric Agency and digitized

The Coast Range, Olympic Mountains, and the Cascades bear the scars of thousands of landslides that have been mapped by geologists. It cannot be demonstrated conclusively that these landslides have an earthquake origin, but certainly many of them do. Some of the smaller ones are slides or flows of soil material, which tend to be tongue shaped or teardrop shaped and to travel down gullies and steep canyons. Many of these form during a wet winter and are unrelated to earthquakes. David Keefer and Randy Jibson of the USGS summarize geotechnical evidence that suggests that some slides would not have been generated by wet weather during winter storms alone but would require seismic shaking to be set in motion. Geotechnical tests, such as the Standard Penetration Test, can be done in an evaluation of a building site on a hillside. Other geotechnical tests include measuring the shear strength of soils under both static (nonearthquake) and dynamic (earthquake) conditions.

The hills bordering the Willamette Valley contain numerous landslide deposits, particularly the West Hills of Portland. The Oregon Department of Geology and Mineral Industries has mapped these landslides using LiDAR, the same method used to map active faults in the Puget Sound region. Most of the Willamette Valley is covered by LiDAR, enabling landslides to be mapped.

Most of Portland is covered with LiDAR-based maps locating these landslides. In my view, due diligence by local government would require these governments to obtain LiDAR maps of their growing cities so that future development can be planned accordingly.

Two large Pacific Northwest landslides may not have had an earthquake origin. The Hope, B. C., landslide of 1965 was associated with an earthquake, but some people believe that the earthquake may have accompanied initial rupture of the shear surface marking the base of the landslide, and was not the cause of the slide. The Ribbon Cliffs rockslide, on the Columbia River north of Wenatchee, Washington, was reactivated by a large earthquake in 1872, as discussed in Chapter 6. Without direct observation, it is difficult to attribute large landslides in mountainous terrain to any earthquake, even when the earthquake occurred in historic time.

I close this section with a discussion of perhaps the most famous landslide in the Pacific Northwest, the Bonneville Landslide on the Columbia River near Cascade Locks (Figure 8-15). Volcanic rocks have been transported downslope on a thin sticky clay soil formed on top of one of the volcanic formations, forcing the Columbia River to its south bank and narrowing its width by half. The landslide has an area of at least thirteen square miles. It may have given rise to a Native American legend concerning the origin of the Bridge of the Gods. According to legend, the Bridge of the Gods was built by the Great Spirit to allow passage

from one side of the river to the other. It was destroyed as a result of a great struggle between warriors now frozen in stone and ice as Mt. Klickitat (Mt. Adams) and Mt. Wyeast (Mt. Hood). A catastrophic landslide in prehistoric times could have dammed the Columbia and allowed people to walk from one side to the other until the river overtopped and cut out the dam. Radiocarbon dating by Pat Pringle, then of the Washington Division of Geology and Earth Resources and Bob Schuster of the USGS shows that this landslide could have come down during the great Cascadia Subduction Zone Earthquake of A.D. 1700.

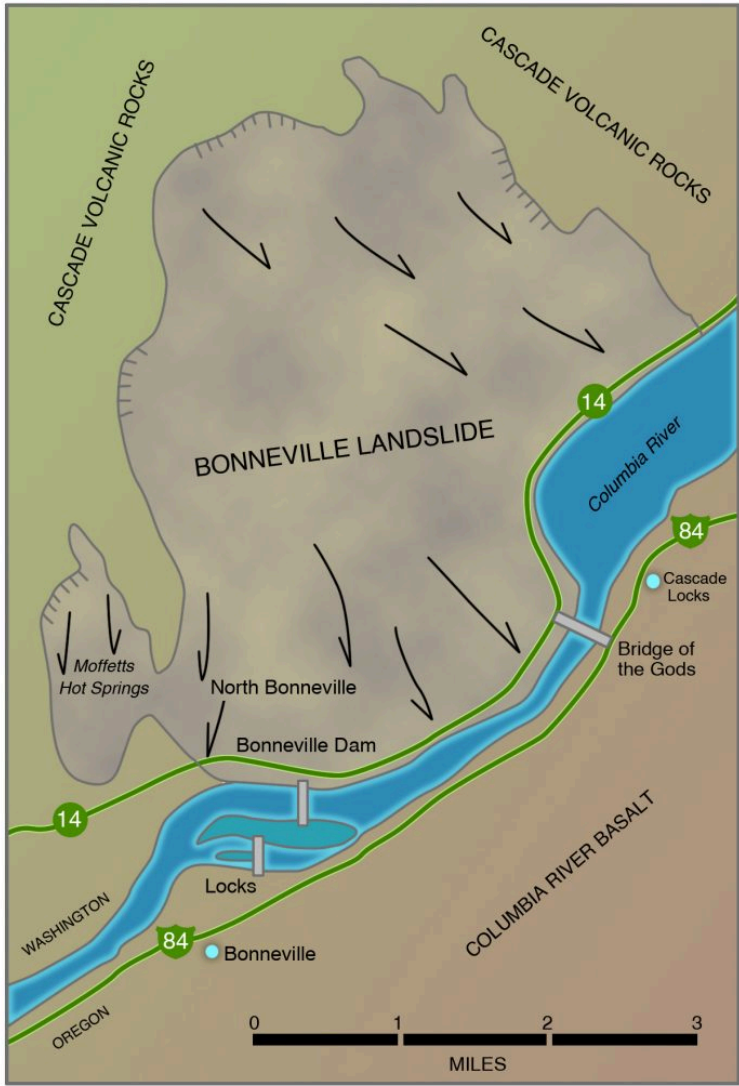

Figure 8-15. Map of the Bonneville landslide (shaded) in the Columbia River Gorge at Cascade Locks. Arrows show direction of flow of landslide material. Bedrock formations shown in clear pattern. Volcanic rocks of the Cascade Range underlie the slide on the Washington side of the Columbia River; Columbia River Basalt is found on the Oregon side. Based on work by Bob

However, there is no direct evidence for an earthquake origin of the slide, and no evidence that the slide came down all at once. Some of the slides coming down to the river from the Washington side are still active today. The Bonneville Landslide and the Bridge of the Gods remain a geological enigma.

As stated in a previous section, landslides are not strictly an earthquake-related phenomenon; they are a common side effect of winter storms as well. In evaluating a site for its landslide potential, Scott Burns of Portland State University uses a three-strike rule. Strike 1 is unstable soil, and strike 2 is a steep slope. Strike 3 may be either an earthquake or a heavy winter rainstorm that saturates the ground. By careful selection of building sites, strikes 1 and 2 can be avoided, so that neither rainfall nor earthquake will cause a landslide.

Much of the loss of life related to an earthquake is caused by landslides. In some cases, the slide mass moves slowly enough that people can get out of its way, but in rockfalls and rock avalanches, such as the large slides in Alaska, Peru, and Montana, and the rockfall witnessed by John Muir at Yosemite, the motion of the rock and soil mass is so quick that people are overwhelmed before they have an opportunity to get

out of the way. This caused the loss of life from the Oso, Washington, landslide of March 2014.

## 5. Earthquake Hazard Maps of Metropolitan Areas

The Oregon Department of Geology and Mineral Industries has prepared maps of the Portland, Salem, and Eugene metropolitan areas that classify the urbanized areas into earthquake hazard zones. The information discussed earlier in this chapter has been used to make the maps: the bedrock geology, the thickness, density, and seismic shear-wave (S-wave) velocity of near-surface sediment, the steepness of slopes in hillside areas, and the degree of susceptibility of those slopes to landsliding. The hazards measured are the amount of seismic wave amplification, the potential for liquefaction, and the tendency of hillslopes to fail in landslides.

The maps divide the area underlain by Quaternary sediment into three (for Portland) to five (for Salem) hazard categories of ground-shaking amplification based on sediment thickness and S-wave velocity. Areas underlain by bedrock do not amplify seismic waves. Similarly, there are three to five categories of liquefaction potential of surficial sediment, with no liquefaction potential for areas underlain by bedrock.

Classification of slope stability is based on steepness of slope ranging from no hazard where the land is flat to a high hazard where the slope exceeds twenty-two degrees, with a special category for hillsides already marked by landslides.

Maps of individual hazards (seismic shaking, liquefaction, and slope stability against landsliding) are combined, using a computer model, to subdivide each area into four earthquake hazard zones, with A marking the highest hazard zone and D the lowest. An A ranking generally means that the area has ranked high in at least two of the three hazards described (seismic shaking, liquefaction, slope stability). An area could rank very high in one category and low in all others and receive a B ranking. The map can be used to state that a broad area such as Portland International Airport has a particular level of hazard (Zone B). The Oregon State Capitol and Willamette University are ranked Zone C. The maps are detailed enough that you could get an idea of the earthquake hazard category for your own home, if you live in one of the areas covered by the maps.

The maps are designed for general planning purposes for designing earthquake hazard mitigation programs for Oregon's major cities. Damage estimates for lifeline services and disaster-response planning could effectively be based on these maps. However, they are not a substitute for site-specific evaluations of a building site based on borings and trenches, although they could be used for feasibility studies and for design.



Furthermore, no state law requires that these maps be used in land-use policy. However, they could affect earthquake insurance rates.

Although there is no province-wide program for earthquake hazard maps in British Columbia, a demonstration project for the city of Victoria has been completed, in part funded by the city itself. The City of Seattle has produced a set of Sensitive Area Maps showing slopes greater than fifteen degrees that might have a greater potential for landsliding. Similar maps are being constructed by the California Geological Survey for urban areas in southern California. The Seismic Hazard Mapping Act, passed by the California legislature in 1990, requires the State Geologist to identify and map the most prominent earthquake hazards from liquefaction and landsliding. Unlike states in the Northwest, developers and local government are required to consult these maps in land-use decisions.

In Washington, Steve Palmer and his colleagues with the Division of Geology and Earth Resources prepared maps showing liquefaction potential in lowland areas of the Seattle and Olympia urban areas because of the extensive liquefaction accompanying the earthquakes in 1949 and 1965. These maps were tested by the Nisqually Earthquake of 2001. Liquefaction and lateral spreading were concentrated in those areas Palmer and his associates had predicted would be hazardous. The Olympia map is shown as Figure 8-16.

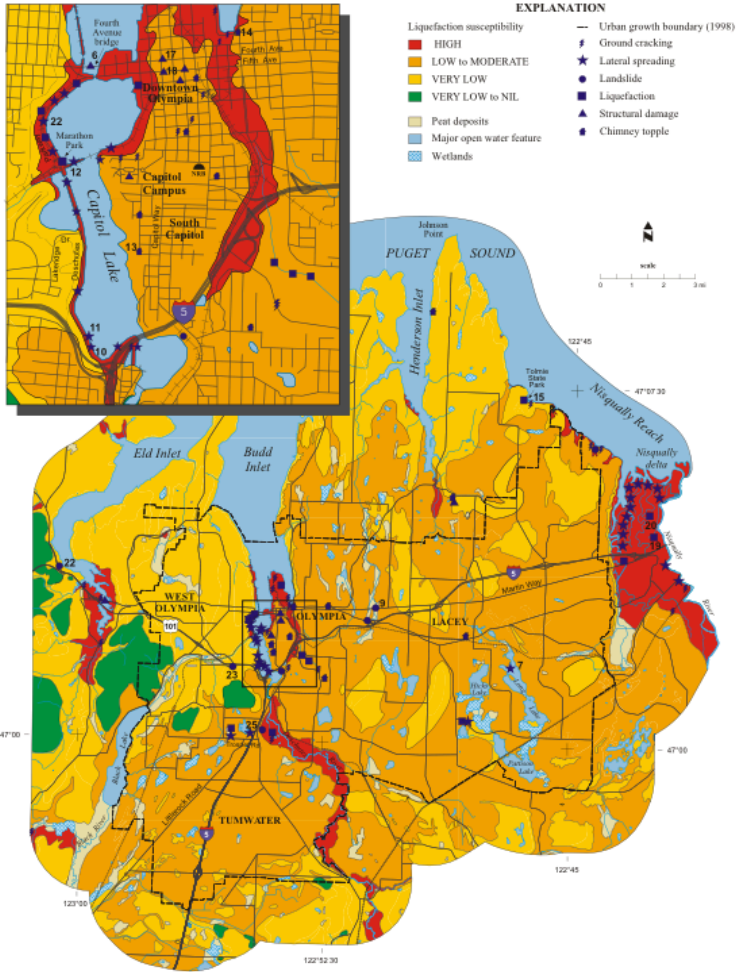

Figure 8-16. Liquefaction susceptibility map of the Olympia-Tumwater-Lacey area, Washington, published as Washington Division of Geology and Earth Resources GM-47 (Palmer et al., 1999). The darkest shading identifies those areas most susceptible to liquefaction and lateral spreading. The damage from liquefaction and lateral spreading from the 2001 Nisqually Earthquake is superimposed on this map, showing how well the map predicted the zones of damage, especially in downtown Olympia. From Tim Walsh, Washington Division of

The Nisqually experience showed clearly that these maps can predict successfully those areas where damage will be concentrated in an urban earthquake. However, they have only been earthquake-tested in Washington.

---

### *Suggestions for Further Reading*

Burns, S. 1998. Landslide hazards in Oregon, in Burns, S., ed., *Environmental, Groundwater and Engineering Geology Applications from Oregon*. Association of Engineering Geologists Special Pub. 11, Star Publishing Co., 940 Emmett Ave., Belmont, CA 94002, p. 303-15.

Burns, S. 1998. Landslides in the Portland area resulting from the storm of February 1996, in Burns, S., ed., *Environmental, Groundwater and Engineering Geology Applications from Oregon*. Association of Engineering Geologists Special Pub. 11, Star Publishing Co., 940 Emmett Ave., Belmont, CA 94002, p. 353-65.

Burns, S., and L. Palmer. 1996. Homeowner's landslide guide. Oregon Emergency Management, Federal

- Emergency Management Agency Region 10, and Oregon Department of Geology and Mineral Industries, 10p. (free).
- Dragovich, J. D., and P. T. Pringle. 1995. Liquefaction susceptibility map of the Sumner 7.5-minute quadrangle, Washington, with a section on liquefaction analysis by Palmer, S.P. Washington Division of Geology and Earth Resources Geologic Map GM-44, 1 sheet, 1:24,000, text 26 p.
- Gerstel, W. J., M. J. Brunengo, W. S. Lingley, Jr., R. L. Logan, H. Shipman, and T. J. Walsh. 1997. Puget Sound bluffs: The where, why, and when of landslides following the holiday 1996/97 storms. *Washington Geology*, v. 25, no. 1, p. 17-31.
- Jibson, R. W. 1996. Using landslides for paleoseismic analysis, in McCalpin, J. P., ed., *Paleoseismology*. San Diego, CA: Academic Press, p. 397-438.
- Keefer, D. K. 1984. Landslides caused by earthquakes. *Geological Society of America Bulletin*, v. 95, p. 406-71.
- Keller, E. A. 1988. *Environmental Geology*, Fifth Edition. Columbus, OH: Merrill Publishing Co., 540 p.
- Kramer, S. L. 1996. *Geotechnical Earthquake Engineering*. Englewood Cliffs, N.J.: Prentice-Hall.
- Monahan, P. A., V. M., Levson, E. J. McQuarrie, S. M. Bean, P. Henderson, and A. Sy. 2000. Relative earthquake hazard map of Greater Victoria showing areas susceptible to amplification of ground motion, liquefaction and earthquake-induced slope

- instability. British Columbia Geological Survey Map GMOO-1.
- Monahan, P. A., V. M. Levson, P. Henderson, and A. Sy. 2000. Relative liquefaction hazard map of Greater Victoria (sheet 3A); relative amplification of ground motion hazard map (sheet 3B); seismic slope stability map (sheet 3C) and accompanying report. British Columbia Geological Survey Maps GMOO-3.
- Muir, J. 1912. *The Yosemite*. The Century Company, republished by Doubleday and Co., Inc., New York.
- Obermeier, S. F. 1996. Using liquefaction-induced features for paleoseismic analysis, in McCalpin, J. P., ed., *Paleoseismology*. San Diego, CA: Academic Press, p. 331-96.
- Oregon Department of Geology and Mineral Industries. n.d. *Landslides in Oregon*. Free circular.
- Oregon Department of Geology and Mineral Industries. 1991-1996. Earthquake hazards maps of Portland and Salem metropolitan areas. GMS 79, 89-92, 104-5.
- Oregon Department of Geology and Mineral Industries. 1997. Relative earthquake hazard map of the Portland Metro Region, Clackamas, Multnomah, and Washington Counties, Oregon. Interpretive Map Series IMS-1.
- Palmer, S .P., H. W. Schasse, and D. K. Norman. 1994. Liquefaction susceptibility for the Des Moines and Renton 7.5-minute quadrangles, Washington. Washington Division of Geology and Earth Resources Geologic Map GM-41, 2 sheets, scale 1:24,000, text 15 p.

- Palmer, S. P., T. J. Walsh, R. L. Logan, and W. J. Gerstel. 1995. Liquefaction susceptibility for the Auburn and Poverty Bay 7.5-minute quadrangles, Washington. Washington Division of Geology and Earth Resources Geologic Map GM-43, 2 sheets, scale 1:24,000, text 15 p. Palmer, S .P., T. J.
- Walsh, and W. J. Gerstel. 1999. Geologic folio of the Olympia-Lacey-Tumwater urban area, Washington: Liquefaction susceptibility map. Washington Division of Geology and Earth Resources Geologic Map GM-47, text, 16 p.

## 9. Tsunami!

*“If the earth shakes east and west the sea will rise up ... The earth did truly shake from the west and everything on the earth fell down .... [A brother and sister] ran on up the hill and the water nearly overtook them .... The water was also coming up the mountain from the east because all the streams were overflowing .... After ten days the young man went down to look about and when he returned, he told his sister that all kinds of creatures both large and small were lying on the ground where they had been left by the sea. ‘Let us go down’ his sister said .... But when they came there, there was nothing, even the house was gone. There was nothing but sand. They could not even distinguish the places where they used to live.”*

From a Tolowa legend recorded by P. E. Goddard in the early 1900s, apparently describing a tsunami on the north coast of California

## I. The Easter Weekend Tsunami of 1964

The warning about a cataclysmic earthquake on the Cascadia Subduction Zone has a mythical cast to it, as if the Earth could not in fact shudder and gyrate in the way scientists have stated it would. But this doomsday scenario is based on an actual subduction-zone earthquake that wracked southern Alaska without warning on Good Friday, March 27, 1964. Alaska is not a heavily populated state, of course, and it had even fewer people in 1964 than it does now. So the human toll was less than that of, say, the Kobe Earthquake in Japan, which was more than a hundred times smaller. But the area of destruction was enormous, stretching for great distances, devastating the city of Anchorage and small towns hundreds of miles away.

The instantaneous effects on the landscape were of a scale seen only once before in this century, in southern Chile in May 1960. Parts of Montague Island in the Gulf of Alaska rose more than thirty feet into the air. Farther away from the subduction zone, a region five hundred miles long and almost a hundred miles across, extending from Kodiak Island to the Kenai Peninsula and Anchorage and the mountains beyond (Figure 4-14), sank as much as eight feet, so that sea water drowned coastal marshes and forests permanently, just as the last great Cascadia Earthquake had drowned the coastline from southern Oregon to Vancouver Island three hundred years ago.



The sudden change in elevation of the land had its equivalent on the sea floor, causing fifty thousand square miles of ocean floor to be abruptly heaved up or dropped down. This produced an effect entirely separate from the earthquake waves that radiated outward through the crust to lay waste to the communities of southern Alaska. The depression and elevation of the sea floor generated an unseen wave in the sea itself that rushed out in all directions. Fifteen minutes after the first subduction-zone rupture had permanently dropped the coastline, a monstrous ocean wave twenty to thirty feet high roared up Resurrection Bay toward the burning city of Seward, carrying ahead of it flaming wreckage, including a diesel locomotive that rode the wave like a surfboard. Residents living near the Seward Airport climbed onto their roofs as the first wave smashed through the trees into their houses, carrying some of them away. Then came a second wave, as strong as the first.

But Seward was ablaze because it had already been hit by a different kind of sea wave, striking less than sixty seconds after the beginning of the earthquake, when the ground was still shaking violently. A section of waterfront slid piecemeal into Resurrection Bay. This landslide triggered three waves up to thirty feet high that reverberated throughout the upper part of Resurrection Bay until the first tectonic tsunami wave arrived fourteen minutes later. Thirteen people died.

Similar scenes were played out in Cordova and Valdez. The entire waterfront of Valdez dropped into the harbor, and the submarine landslide generated monster waves over one hundred sixty feet high, taking thirty lives. Valdez ultimately would be relocated to safer ground.

These were the waves that headed to the nearby Alaskan shore. But other waves rolled silently southward into the Pacific Ocean at hundreds of miles per hour (Figure 9-1). A ship on the high seas might encounter these long-period waves, and its crew would not be aware of them. There would just be an imperceptible lifting of the hull as the waves passed underneath. But when a

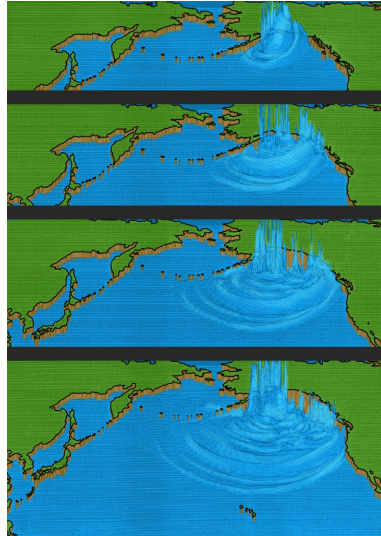

Figure 9-1. Computer simulation of tsunami following Good Friday 1964 Earthquake in the Gulf of Alaska. Top image shows waves one hour after the earthquake; successive images show waves at two, three, and four hours after the earthquake. Japan at left; west coast of United States on right; Hawaii at bottom center of lower image. Tsunami has reached Vancouver Island in third image and is about to strike Crescent City, California, in bottom image. Note that waves approaching Japan are much smaller than those approaching the United States; also note how waves turn toward the coast as they slow down. From Kenji Satake, Geological Survey of Japan

wave entered shallow water, it slowed down and gained in height until it towered above the shoreline in its path. The movement of the sea floor that had triggered the tsunami had a directivity to it, preferentially southeast rather than south toward Hawaii or southwest toward Japan (Fig. 9-1). The Alaska Tsunami was like a torpedo fired directly at the coast of Vancouver Island, Washington, Oregon, and California.

An hour and twenty-six minutes later, the Pacific Tsunami Warning Center at Ewa Beach, Hawaii, issued a tsunami advisory indicating that a sea wave could have been generated by the earthquake. None had yet been confirmed, despite the damage to towns along the Alaska coastline, mainly because communications between Alaska and Hawaii had been lost. The main concern at the Tsunami Warning Center was for a tsunami in Hawaii, similar to previous destructive tsunamis in 1946, 1952, 1957, and 1960. The warning center gave an expected arrival time of the tsunami in Hawaii.

Fifty-three minutes after the tsunami advisory was issued, a report from Kodiak Island, Alaska, told of seismic sea waves ten to twelve feet above normal. Thirty-five minutes later, a second report was received from Kodiak, and, based on those two reports the Pacific Tsunami Warning Center upgraded its tsunami advisory to a tsunami warning. At almost the same moment, nearly three hours after the earthquake, the tsunami made landfall on the northern tip of Vancouver Island.

The western slope of Vancouver Island was carved by great Pleistocene glaciers, and when the glaciers melted, they left narrow, steep-walled canyons that filled with seawater and became fjords. The fjords concentrated the force of the tsunami like air scoops, with the effect that towns at the landward end felt the worst effects of the waves.

The tsunami swung left past Cape Scott into Quatsino Sound and bore down on Port Alice, ripping away boat ramps and seaplane moorings, flooding buildings, floating twelve houses off their foundations, and tumbling thousands of feet of logs along the waterfront like jackstraws. Farther south, the wave entered Esperanza Inlet and swept buildings off their foundations in the village of Zeballos, at the head of the fjord. Next it was the turn of Hot Springs Cove, an Indian village where eighteen houses were damaged. At Tofino, the wharf was damaged and the water pipeline on the sea floor was breached. Log booms were damaged, and a fishing boat sank at Ucluelet.

Near Ucluelet, the wave turned inland into Barclay Sound, thundering past Bamfield Lighthouse and a group of fifty startled teenagers on Pachena Beach. The lighthouse raised the alarm, which gave ten minutes' notice to the twenty-five thousand residents of Port Alberni, at the head of the fjord nearly two-thirds of the way across Vancouver Island. Larry Reynolds, eighteen, raced from his house on high ground to watch after the first wave had hit at 12:10 a.m. on March 28, knocking out the tide gauge. As the second and most destructive

wave surged into the street at 2:00 a.m., Reynolds could hear people screaming and could see men running in front of the wave as it crashed into the town. The lights along the waterfront went out, and the ground floor of the Barclay Hotel, one mile inland, was splintered. Two large two-story houses were lifted from their foundations; they floated serenely out into the Somass River, where they broke up and sank. A row of six tourist cabins along the river bank bowed gracefully as they rose up simultaneously, but then they came down separately as the wave passed. The third wave at 3:30 a.m. was highest of all, but the tide was going out, and the wave did little additional damage. Smaller waves continued to be felt in Alberni Inlet for the next two days. Two hundred and sixty homes were damaged, sixty severely. Economic losses in Port Alberni were \$5 million in 1964 Canadian dollars.

Port Alberni was the southernmost town at the head of a fjord, and so the wave rolled southeast across the Strait of Juan de Fuca, and it was recorded by the tide gauge at Neah Bay. Logs were scattered in Quilcene Bay near Hood Canal. But the main tsunami continued on past Cape Flattery and the wild, uninhabited coastline of Olympic National Park. Incredibly, no lives had been lost on Vancouver Island nor on the Washington side of the Strait of Juan de Fuca.

By this time, warnings of the oncoming tsunami were being broadcast throughout the Pacific Northwest. One of those who heard the warning was Mrs. C. M. Shaw, whose daughter and son-in-law were spending the

weekend at Kalaloch Resort in Olympic National Park with their eleven-year-old daughter, Patty, along with another couple, Mr. and Mrs. Charles W. Elicker, and the Elickers' eleven-year-old son, Drew. Mrs. Shaw phoned the resort, and an employee found Elicker. Horror-struck, Elicker raced for the beach, where the two children had been given permission to camp for the night. Elicker routed them from their sleeping bags, and Drew raced for a forty-foot embankment of clay with a sparse cover of salmonberry. But Patty wanted to collect her pup tent and sleeping bag. Elicker realized that there was no time. In the moonlight, he could see the great wave rumbling toward them, a churning wall of water jumbled with logs and driftwood. He grabbed Patty's hand and they raced toward the embankment and safety.

But Elicker was losing the race with the tsunami. Gripping Patty's hand, he scrambled up the embankment, grasping at brush, and he finally managed to cling to a spindly tree as the wave drenched them up to hip level. As the initial surge retreated, Elicker climbed higher, where another part of the wave hit them at leg level. But they were safe. The next day, they found Patty's pup tent and sleeping bag a half mile down the beach.

On came the wave down the coast, refracting to the east and heading for shore at a low, oblique angle. It struck the Quinault Indian Reservation, startling four Tacoma men from their tent on the beach at Taholah, south of Pt. Grenville.

A half mile north of the tiny community of Copalis Beach, Mr. and Mrs. David Mansfield and their children Robert, twenty, Linda, fourteen, and David, seven, were camped on the beach in their trailer. They had been up until eleven o'clock, walking on the beach in the moonlight. Shortly after they turned out the light, their trailer began to rock, and as they looked outside their window they saw their car floating away. The trailer began to roll, with the Mansfields still inside, and they suddenly found themselves tumbling outside the trailer, under water. They swam toward land, but as they tried to reach a place where they could stand, they were battered by a huge log that threatened to crush them. Linda was drifting away, but Robert grabbed her and finally, miraculously, they all reached firm ground. The force of the waves had torn off most of their clothes; all Mrs. Mansfield had on was a T-shirt when they wandered into a tavern looking for help.

The wave then reached Copalis Beach itself, where the firehouse siren in the shopping area began to wail an alarm. Leonard Hurlbert dashed out of the Surf and Sand Restaurant, where his wife worked in the kitchen, to race home and check on their sleeping children. He was driving close to fifty miles an hour when he reached the bridge across the Copalis River (Figure 9-2). A few seconds earlier and he would have made it. But he reached the bridge at the same time as a wall of water from the sea. The bridge began to buck and heave, and over it went, pitching Hurlbert, still in his car, into the river. Trapped underwater, he forced open

the door on the driver's side against the pressure of the water. But as he was escaping, he found his leg pinned between the top of the door and the roof of the car. With the desperate force of a drowning man, Hurlbert somehow freed his leg and hurled himself toward air, severely damaging the ligaments in his left arm as he did so.



*Figure 9-2. Bridge across Copalis River, Washington, destroyed during the tsunami accompanying the 1964 Good Friday Earthquake in southern Alaska.*

The tsunami roared through an inlet north of Westport into Grays Harbor, where three log rafts of the Saginaw Shingle Co. broke up and had to be cleared by tug. In the northern part of Willapa Bay, strong currents damaged oyster beds, transporting oysters more than a half-mile away, and burying other beds beneath sand. The Moore Cannery building was lifted off its



foundation so that it slammed into the south approach of the Highway 101 bridge across the Bone River.

And still the giant waves rolled relentlessly south, past four Renton boys driven from their tent at Long Beach, past Cape Disappointment to the Oregon coast, where the tsunami turned deadly. At Seaside, on a sandbar separated from the mainland by a channel, the waves pushed the Necanicum River back up its bed, overflowing and drowning out a trailer park. Mary Eva Deis, fifty, died of a heart attack when the waves struck her house. Farther south at Cannon Beach, a wharf was swept away, carrying several small boats out to sea. Several houses were ripped from their foundations.

At Beverly Beach, north of Newport, Monte McKenzie, a Boeing engineer from Seattle, his wife Rita, and their four children—Louis, eight, Bobby, seven, Ricky, six, and Tammy, three—had come to spend the Easter weekend camping. On Friday, they were following a trail along the coast when they found a driftwood shelter. What an experience to camp directly on the beach on such a beautiful spring weekend! They got permission from the caretaker of Beverly Beach State Park to camp there. They had settled in for the night when a small wave caught them in the shelter. They had time to grab the kids, and they were running for the beach cliff when the first of the great waves struck. Rita was a senior Red Cross lifesaver and had taught all her children to swim. She gripped two of them by the hands, but great, shifting logs knocked her unconscious. Monte was thrown against the cliff, where

he climbed up and vainly tried to flag down cars on Highway 101. He ran to the caretaker's house, and police were called, but it was too late. Rita was found on the beach four hundred yards away from their campsite, battered but alive. But the kids were gone. They found Ricky's body, but the other three were never recovered.

The tsunami swept down the Oregon coast, tearing out docks and smashing small boats at Gold Beach at the mouth of the Rogue River, and on into California. Crescent City lay in its path.

The California Disaster Office issued a bulletin at 11:08 p.m. to emergency response officials and the California Highway Patrol in all coastal counties that a tsunami was possible. This bulletin was received at the Del Norte County Sheriff's headquarters, and by 11:20, the civil defense director and the sheriff had arrived at headquarters. At 11:50, the California Civil Defense Office estimated the arrival time of the tsunami at midnight. By the time a second bulletin had arrived at 11:50, sheriff's deputies had been sent to low-lying areas to warn people of a possible sea wave. However, they did not order an evacuation.

The first wave arrived on schedule at 11:59 p.m., after the warning had been repeated by both radio stations. But the first wave was fairly small, reaching across the beach only to Front Street and doing little damage other than depositing some debris. Civil Defense authorities had received a report from Neah Bay, Washington, that the tsunami had done no damage there. People began to relax. The next wave at 12:40

a.m. on March 28 was larger, but still not too bad. The sea waves were behaving like tsunamis that had hit Crescent City in 1946, 1952, 1957, and 1960: flooding some low-lying areas and that was about it. The worst appeared to be over, and some people headed for their homes or to the waterfront to survey the damage to their businesses and begin to clean up. The sheriff's office still had not issued a general alarm.

Then at 1:20 a.m. came the third wave, a giant wall of water fifteen feet high that breached a jetty, smashed into the fishing fleet at Citizens Dock at Elk Creek, and roared across Highway 101 south of town. Jack McKellar and Ray Thompson had gone down to the harbor earlier to check on Thompson's boat, the *Ea*. As they loosened the moorings, the wave spun the *Ea* around like a top, and the boat shot out of the harbor into the open sea. The two men were carried so far from shore that they were spared the worst effects of the tsunami.

The wave caved in the west wall of the Long Branch Tavern at Elk Creek, terrifying the patrons when the lights went out. People jumped up on the bar and juke box, with scarcely any headroom for breathing. Everyone climbed up onto the roof, and Gary Clawson and Mack McGuire swam out to get a boat. When they returned, seven people, including Clawson and his parents, got into a rowboat. The water was smooth, and they headed across Elk Creek toward Front Street. They were only a few boat-lengths away from the stream bank when the drawdown began, pulling the boat sideways toward the Elk Creek bridge. Bruce Garden

lunged and grabbed the bridge, which kept him from going under. The other six were slammed against a steel grating on the far side of the bridge, choked with debris. Clawson, a strong swimmer, came up for air, and as the water receded he tried to revive the others. But the other five passengers drowned in the darkness.

The fourth wave at 1:45 a.m., largest of all, crested at nearly twenty-one feet. Peggy Sullivan, six months pregnant, saw the waves from the front door of her room at Van's Motel. She told her son Gary, nine, to dress, and threw a quilt around her twenty-three-month-old daughter Yevonne. As they stepped outside with Yevonne's bottle, a wall of water came toward them, carrying houses like matchboxes. Gary was carried off in one direction and Sullivan and the baby in the other: Peggy's shoes and the baby's quilt were torn away at the same time. She was swept down the driveway and became jammed against a sports car, driftwood piled at her back, but still held onto Yevonne and her bottle. Gary was carried into the back of a garage, where he was rescued by a stranger. Severely injured, Peggy Sullivan was taken to the hospital. Although she and her two children survived, she lost her unborn child.

The third wave swept into downtown Crescent City, tearing out a twenty-five-ton tetrapod used in the construction of the seawall. Stores along Front Street crumbled. At first, boats were washed four blocks inland, then they and the wreckage of buildings were carried out to sea by the suction as the water retreated

(Figures 9-3 and 9-4). The Texaco oil tank farm burst into flames and the tanks exploded, causing fires that burned out of control for more than ten hours.



*Figure 9-3. Aerial view of Crescent City, California, after the tsunami accompanying the 1964 Good Friday Earthquake in southern Alaska. Harbor is toward the viewer. Photo courtesy of Lori Dengler, Humboldt State University*



*Figure 9-4. Damage from the 1964 tsunami in Crescent City, California. Photo courtesy of Washington Division of Geology and Earth Resources*

Wally Griffin described the scene from the sheriff's office when the lights went out: "There was a continuous crashing and crunching sound as the buildings gave way and splintered into rubble, and there were flashes from high powered electrical lines shorting out that resembled an electrical storm approaching from the east, except some of the flashes were blue. Added to the display were two explosions that could have been mistaken for thunder without the normal rolling sound."

A big log crashed through the walls of the post office, and, as reported by Griffin, "when the water receded, it sucked the letters out like a vacuum cleaner." The

letters were later found festooning the parking lot and nearby hedges. Adolph Arrigoni, seventy, drowned in his house on B Street, and James Park, sixty, drowned when the wave floated his trailer off its foundation.

Peggy Coons, curator of the Battery Point Lighthouse on an island west of the Crescent City Jetty, had gotten up before midnight to go to the bathroom when she noticed in the moonlight that all the rocks around the island on which the lighthouse stood had disappeared. She and her husband dressed and went outside, where they saw a huge, debris-choked wave, high above the outer breakwater, bearing down on the town. Then the water roared back past them at high speed, leaving the beach strewn with debris. The second wave passed them, and they saw lights blinking out along the shoreline. Again the water drained back past them to the sea.

The third wave started fires in the town, and sparks flew. When the water drained out this time, three-quarters of a mile from the normal shoreline, it revealed the sea bottom, described by Peggy Coons as a “mystic labyrinth of caves, canyons, basins and pits, undreamed of in even the wildest fantasy.”

In the distance, Coons could see a massive black wall of water, with boiling and seething whitecaps glistening in the moonlight. A Coast Guard cutter and several smaller boats two miles offshore appeared to be riding high above the wall. The water struck with great force and split around the island, picking up driftwood logs as it struck the mainland. They saw bundles of lumber at

Dutton's Lumber Yard fly into the air as other bundles sailed away. There was a great roar, and buildings, cars, boats, and lumber were moving and shifting. Then the return wave came past them, carrying a slurry of mattresses, beds, furniture, television sets, and clothing. Coons saw more waves, but they were smaller. The damage had been done.

The waves destroyed twenty-nine blocks and left one hundred fifty businesses a total loss. Eleven people had died. Governor Edmund G. Brown asked the president to declare Crescent City a disaster area.

And still the tsunami sped south, trapping Stuart Harrington and Donald McClure, two Air Force sergeants who were eel fishing at the mouth of the Klamath River, south of Crescent City. A wall of water, choked with driftwood, picked them up and carried them a half-mile up the river. They scrambled through the driftwood to the surface, and McClure helped Harrington climb up on a larger log that appeared to offer protection. They heard a response to their cries for help. Then the water and floating logs began to rush back toward the sea, and both men slipped into the water to swim for shore. McClure had helped Harrington remove his jacket and shirt to make it easier for him to swim. Harrington swam through the maelstrom to the shore, below the boat docks, where he found to his horror that McClure, who had saved Harrington's life, had lost his own.

The tsunami continued south of Cape Mendocino, causing havoc on the Mendocino coast. The wave was



still three feet high near the Golden Gate Bridge. At Sausalito, the mooring cables of the sixty-six-year-old ferryboat *Berkeley* snapped, causing the ferry to list and damage the pier. Altogether, the damage to boats in San Francisco Bay amounted to nearly a million dollars. A ship ran aground at Gaviota, boats were damaged farther east at Santa Barbara, and Los Angeles suffered \$200,000 in losses. Damage was reported in San Diego, and ten-foot waves struck Catalina Island off the southern California coast. An alarm was raised on the west coast of Mexico, but the tsunami, finally, was spent. Tide gauges recorded the tsunami all around the Pacific Ocean, including Antarctica; it was recorded in Peru nearly ten hours after the fourth wave struck Crescent City and nearly sixteen hours after the earthquake.

But the tsunami was not quite finished with the coast of Washington. The greatest destruction within Willapa Bay occurred the following day, twelve hours after the earthquake, near Raymond and South Bend. Ed Norman, Bill Campbell, and Ed Triplett were working at Port Dock, about a mile downstream from Highway 101, when a series of surges struck shortly before low tide. The water dropped six to eight feet, temporarily grounding a tug, then, when the current reversed, it broke up a 550-foot log raft that had been tied to Port Dock. At Bay Center, Sam Pickernell was out crabbing when a series of surges, ten minutes apart, emptied the sloughs and rolled oysters onto the shore. This lasted thirty to forty-five minutes.

What was learned? First, except for the tsunami at Seward and Valdez, Alaska, the loss of life was entirely preventable, because there was plenty of time to evacuate low-lying coastal areas even as far north as Vancouver Island. The first two waves at Crescent City were no larger than previous tsunamis, convincing local authorities that the worst was over and no evacuation order was necessary. For warnings to be heeded, people had to have their radios or television sets on; a siren powered by an emergency generator would have been more effective, combined with emergency-service personnel noisily alerting people to the danger.

A second tsunami warning center was established at Palmer, Alaska, to improve the warning system and to better understand the dynamics of tsunami wave propagation. In addition, British Columbia, Washington, Oregon, and California began to study their coastlines and offshore regions to understand better how tsunamis worked and how their effects could be dealt with.

A quarter-century would pass before Kenji Satake would develop computer models showing the directivity effects of tsunamis, the pointed gun of the Alaska Earthquake aimed directly at the west coast of North America (Figure 9-1). And there were many low-lying coastal areas that were *not* hard hit, indicating that the wave was strongly controlled by the bottom topography of the sea floor that channeled and accentuated the tsunami as it headed for shore.

## 2. Other Tsunamis in the Pacific Northwest

The 1964 tsunami was the most damaging to strike the Pacific Northwest in recorded history, but it was not the only one. Tide-gauge records show that subduction-zone earthquakes in the Aleutian Islands generated tsunamis that were detected in Tofino and Victoria, B.C., Neah Bay, Washington, and Crescent City, California. A larger tsunami resulted from the 1960 earthquake in southern Chile of M9.5, the largest of the twentieth century (Figure 4-17). Wave heights for the Aleutian-based tsunamis were about one-fourth those in 1964, and those accompanying the Chilean earthquake were about half the wave heights in 1964. For all pre-1964 tsunamis, Crescent City had the greatest wave heights, as it did in 1964, evidence that there is something special about the configuration of the sea floor off Crescent City that causes focusing of tsunami waves as they enter shallow water.

The next tsunami arrived on March 11, 2011, as a result of the subduction-zone earthquake of M 9 off Japan. That earthquake was similar to the next earthquake expected on the Cascadia Subduction Zone. Its directivity caused greater effects off the California coast than in areas farther north, but it indicated that the truly great earthquakes would have effects thousands of miles from their sources. Damage was largely restricted to small boat basins in Brookings and

Depoe Bay, Oregon, and Crescent City, California. Figure 9-6 is a photo of the tsunami wave near Emeryville, California, north of Oakland.

The twentieth-century tsunamis were relatively small compared with the tsunamis that struck the northeastern Japan coast on March 11, 2011 or those that accompanied the last Cascadia Subduction-Zone earthquake in January 1700. As pointed out in Chapter 4, this tsunami even did damage in Japan, more damage than the 2011 Tohoku-oki tsunami did in western North America. The buried peat deposits at Willapa Bay, Washington,



*Figure 9-5a. Exposure at low tide of sediments below the modern tidal marsh at Willapa Bay, southwest Washington. The shovel blade is at the top of the dark soil layer marking a former marsh that subsided abruptly in A.D. 1700 during the last Cascadia Subduction Zone earthquake. The strongly layered sediments just above the soil layer are sands deposited by a tsunami that immediately followed the subsidence. Photo by Brian Atwater, USGS*

and other areas are directly overlain by layers of laminated sand that were derived from the sea (Figure 9-5a). Figure 9-5b is a photo of a deposit from the 1700 earthquake that overlies Native American fire pits. Sand thickness and grain size diminish away from the sea. Tsunami sands from inlets on northwestern Vancouver Island preserve a record of both the A.D. 1700 tsunami and the tsunami that came from Alaska in 1964. In

southern Oregon, Bradley Lake formed behind a sandbar, showing evidence of giant waves sweeping across the sandbar and depositing sand and marine diatoms in the lake. Thus it is likely that the next Cascadia Subduction Zone earthquake will be accompanied by a devastating tsunami. The damage will be worse in Oregon, Washington, and Vancouver Island because the tsunami will strike areas that have just subsided several feet as a consequence of the earthquake, just as coastal areas of Japan subsided during the 2011 Tohoku-oki earthquake and tsunami.

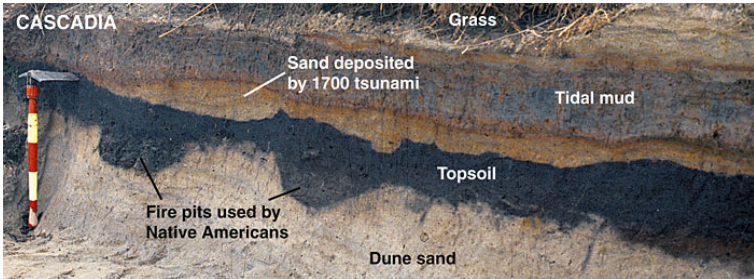

Figure 9-5b. Photo of 1700 tsunami overlying topsoil and Native American fire pits at Salmon River, Oregon.

The earthquake on the Seattle Fault also produced a tsunami that was recorded at the base of Magnolia Bluff in Seattle, at the mouth of the Snohomish River near Everett, and on the south end of Whidbey Island. NOAA, in addition to planning for a tsunami on the Cascadia Subduction Zone, also is planning for a tsunami accompanying rupture of the Seattle Fault.



Figure 9-6. March 2011 tsunami near Emeryville, near Oakland, California.

### 3. Some Facts about Tsunamis

First, a tsunami is *not* a tidal wave. Tides are caused by the attraction between the Moon and Earth, and tsunamis are completely unrelated. If a tsunami arrived at the same time as a high tide, as it did at Crescent City, its effects would be worse than if it arrived at low tide, because the wave could travel farther onto the land. Another term is *seismic sea wave*. This is correct for most tsunamis, but not all, for tsunamis can be generated by submarine volcanic eruptions or submarine landslides. The cataclysmic eruption in 1883 of Krakatau, a volcanic island in Indonesia, was followed by a sudden collapse of the central volcano and an

inrush of water, generating a tsunami that, together with the eruption, killed more than thirty-six thousand people.

We use the Japanese word *tsunami*, from the Japanese characters for *harbor wave*, in light of the fact that a tsunami increases in height as it enters a harbor, as it did at Port Alberni and Crescent City (Figure 9-7).

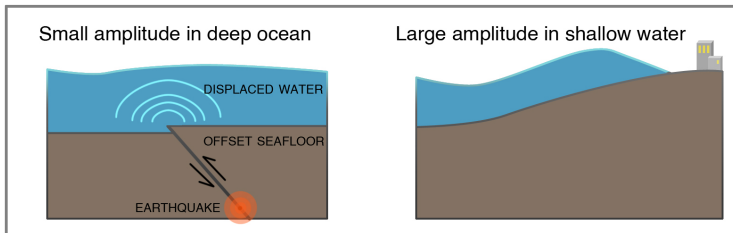

Figure 9-7. (Left) Formation of a tsunami by sudden offset of the sea floor. Wave has a low amplitude as it travels in the deep sea. (Right) Wave amplitude grows as tsunami enters shallow water and approaches the land.

In the Alaska Earthquake of 1964, a section of sea floor more than four hundred miles long and one hundred miles across suddenly arched upward, forcing the overlying water upward and outward as if the sea floor were a giant paddle (Figures 4-14 and 9-7). Although this happened almost instantaneously, it was not the *speed* of the uplifted seas but the sheer *volume* of water displaced that produced the powerful tsunami. A tsunami generated by a sudden change in the deep ocean floor is a wave that extends from the bottom

to the sea surface. The wave travels at great speed, five hundred miles an hour or faster, depending on the depth of the ocean.

The wave travels fastest through the deep ocean and slows down as it approaches the land, as can be observed in the computer simulation in Figure 9-1. The waves traveling down the coast are slower than those in the open sea, so that the wave front of the 1964 tsunami made a sweeping turn to the left and attacked the coast almost head on.

Tectonic tsunamis have very long wave periods. (Figure 3-12 illustrates wave amplitude and wavelength; the period is the length of time it takes a full wavelength to pass a point.) An ordinary ocean wave breaking on the beach has a period of five to fifteen seconds, but a tsunami generated by a subduction-zone earthquake has wave periods ranging from seven minutes to nearly an hour, depending on the origin of the tsunami. It was the long periods of twenty-five to forty minutes that caused so much havoc at Crescent City and elsewhere. The wave rushed onshore and then it receded. When this happens, observers assume that the tsunami differs from an ordinary ocean wave in size only. If the next wave does not arrive in the next few minutes, they assume that the danger is past. They return to the shore, out of curiosity or a desire to help in rescue or cleanup operations. Then, perhaps as much as an hour later, another giant wave strikes. The loss of life from the follow-up wave, which might be bigger than the



first one, is commonly larger than that from the initial wave.



*Figure 9-8. Tsunami accompanying Tohoku-oki Earthquake of March 11, 2011 as it overwhelmed the seawall constructed against an earthquake expected to be no larger than M 8.4. Instead, its magnitude was 9.*

Figures 9-9 and 9-10 graphically (and disturbingly) illustrate the folly of rushing to the ocean too soon. In Figure 9-9, tourist swimmers have ventured away from shore as the next wave approaches. The sea bottom in the foreground is exposed because the incoming wave was immediately preceded by a drop in water level from the previous wave, giving the swimmers a false sense of security. The swimmers in the center of the photo realize that the next wave is approaching them, but it is too late for them. They were all drowned in the tsunami. In Figure 9-10, tourists have rushed to the shore to

photograph the incoming tsunami, but the wave was much higher than they expected, and they also lost their lives.



*Fig. 9-9. Swimmers at tourist resort of Phuket facing the December 26, 2004 tsunami accompanying an earthquake of M 9.15 off the northern tip of Sumatra. Although people now recognize their danger, it was too late, and all drowned in the tsunami. In the foreground, the sea bottom is exposed because the first wave was a drop in sea level.*

These two photos are a warning. If you hear a tsunami warning, DON'T GO TO THE BEACH; go to high ground immediately and stay there until you are told it is safe to return. It is my prayer that these two photos will save lives.

A tsunami has almost no expression on the ocean surface. (Here Figure 9-1 is misleading, because it gives the impression that great wave heights are found in the deep ocean as well as along coastlines.) The height of a tsunami on the open ocean is typically only a few feet—less than the normal surface waves, and the wave height is gradual, not like a breaking wind-generated wave. Ships at sea cannot give warning, because people on board cannot detect the passage of the tsunami beneath the ship. During a deadly tsunami that struck Hilo, Hawaii in 1946, the crew of a freighter anchored offshore was surprised to see huge waves



*Fig. 9-10. Tourists at Phuket resort have rushed to the beach to photograph the incoming tsunami accompanying the December 26 M 9.15 earthquake off Sumatra. However, the tsunami wave was much higher than they expected, and most were drowned by the wave. This photo is included to discourage people from rushing to the beach after a Cascadia tsunami warning.*

breaking over buildings and trees onshore, because they were not strongly affected by the wave passing under their ship.

As a tsunami enters shallow water, it slows down but does not lose energy. It converts to a gigantic surface wave (Figures 9-7, 9-8, and 9-9). The way in which the tsunami approaches the shore is of critical importance in tsunami hazard analysis. It depends on the direction and energy of the approaching tsunami, of course, but it is also influenced by the configuration of the sea floor. Hilo Harbor in Hawaii is particularly susceptible to tsunamis because the adjacent sea floor is shaped like a funnel, concentrating the energy of the wave into a smaller area. In a similar fashion, the Vancouver Island fjords concentrated the wave energy of the 1964 tsunami like the nozzle of a fire hose, smashing against the communities at the heads of the fjords. Crescent City has a similar problem. Because the tsunami is controlled by water depth, even in deep water, the configuration of offshore banks and submarine canyons influences the size of a tsunami. Topographic maps of the sea floor, called bathymetric maps, are available for the west coast of the United States from the National Oceanic and Atmospheric Administration (NOAA). These bathymetric maps are important in determining which sections of a coastline are most susceptible to tsunamis.

In the 1964 earthquake, the sea floor was suddenly pushed upward and outward to the southeast, so that the first evidence of the tsunami in the Pacific

Northwest was the great wave that crashed on the beaches and entered the harbors. But at Seward, Alaska, on the north side of the uplift, the force of the earthquake propagated *away* from the town. People at Seward saw a huge wave approaching them, but as they looked at the remains of the small-boat harbor, they observed that it had been magically drained of water. This was part of the tsunami, too, but the sea had rushed away from land rather than toward it, immediately followed by the first wave to drive into the port and town.

Seward, and Cook Inlet behind it to the northwest, abruptly subsided during the earthquake, just as the coastal marshes of central Oregon, Washington, and Vancouver Island had subsided during the great Cascadia Earthquake of A.D. 1700, and previous earthquakes as well. If the next Cascadia earthquake behaves like the illustration in Figure 4-14, then the first evidence of the accompanying tsunami in northern Oregon or Washington might be a sudden outrushing of water, followed by a great wave. Coastal areas would see exposed parts of the sea floor that people living there had never before seen exposed (Figure 9-9), even at the lowest tides. There would be a great temptation to go to the beach to see this phenomenon—which could be fatal because there would not be enough time to get back to high ground before the first wave struck (Figures 9-9, 9-10).

Computer modeling of a Cascadia Subduction Zone tsunami predicts a different outcome for northern

California because the coastline is much closer to the subduction zone than it is farther north (Figures 4-12, 4-22). The northern California coast would be suddenly uplifted, whereas the coast farther north would suddenly subside (Figure 4-14).

For those people who are into extreme sports, be advised that tsunamis are NOT surfable. The wave does not curl. It generally comes ashore as a rapidly rising surge of turbulent water choked with debris, including large logs. Even if a surfer managed to avoid being bashed to death by the maelstrom of debris, he or she could never “catch” the wave.

## 4. Tsunami Sounds

Most observers of a great tsunami are so horrified that they remember only what they saw rather than what they heard. However, Jerry Eaton, a seismologist with the USGS, was at a bridge across the Wailuku River in Hilo, Hawaii, on the night of May 22, 1960, as a tsunami from a monster earthquake in Chile approached the city. Eaton heard “an ominous noise, a faint rumble like a distant train, that came from the darkness far out in Hilo Bay. Two minutes later, ... the noise became deafening.” Carol Brown, sixteen, heard “a low rumbling noise that soon became louder and was accompanied by sounds of crashing and crunching.”

## 5. Tsunami Warning Systems

The tsunami at Crescent City struck more than four hours after the earthquake. Loss of communication with Alaska delayed the issuance of a tsunami advisory for nearly an hour and a half after the earthquake, and the advisory was not upgraded to a warning until two hours and twenty minutes after the earthquake—about the time the first wave was striking the north end of Vancouver Island.

The warning system in place at that time—the Pacific Tsunami Warning Center—was established in Hawaii after a disastrous tsunami in Hawaii in 1946 caused by an earthquake on the Aleutian Subduction Zone of Alaska. The Hawaii center was not designed to warn against tsunamis like the one produced by the 1964 Alaska Good Friday Earthquake, so a second warning center was set up—the West Coast/Alaska Tsunami Warning Center in Palmer, Alaska. Both are operated by NOAA. The Alaska center initially was organized to warn against tsunamis only in Alaska, but now it's responsible for alerting Alaska, British Columbia, Washington, Oregon, and California about all earthquakes around the Pacific that might produce a tsunami.

Seismographs and tide gauges around the Pacific Rim report immediately to Ewa Beach, Hawaii, and Palmer, Alaska, and tsunami arrival times are estimated for shorelines around the Pacific. The Deep-ocean

Assessment and Reporting of Tsunamis (DART) Project has installed pressure gauges on the deep ocean floor, permitting tracking of tsunamis in the deep sea in real time, which has never before been possible (Figure 9-11). NOAA has a large number of DART tsunami detectors in the Pacific Ocean and a few in the Atlantic and Indian oceans (Figure 9-12). There were enough DART buoys in place that the magnitude 9 Tohoku-oki earthquake was tracked by the buoys as it traveled from Japan across the Pacific Ocean. In addition, the seismic networks in southern Alaska, western Washington and Oregon, and northern California were upgraded.



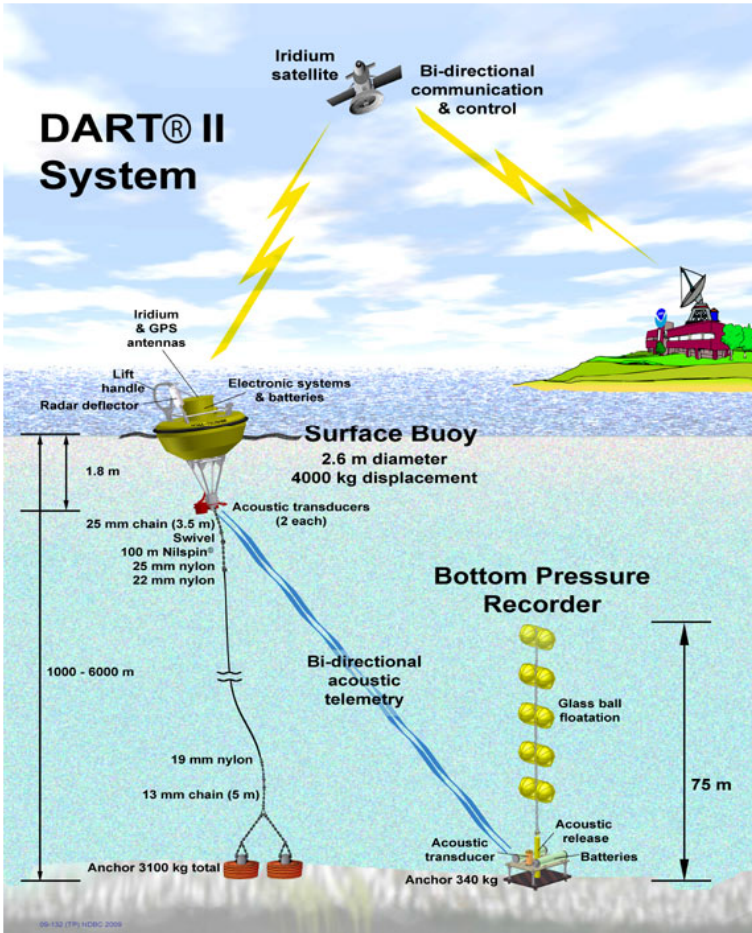

Fig. 9-11. A DART buoy installed by NOAA as part of a tsunami warning service. The buoy is connected to a pressure recorder on the sea bottom that transmits the elevated pressure of a tsunami wave passing over it. This information is transmitted to the two tsunami warning centers in Hawaii and Alaska.

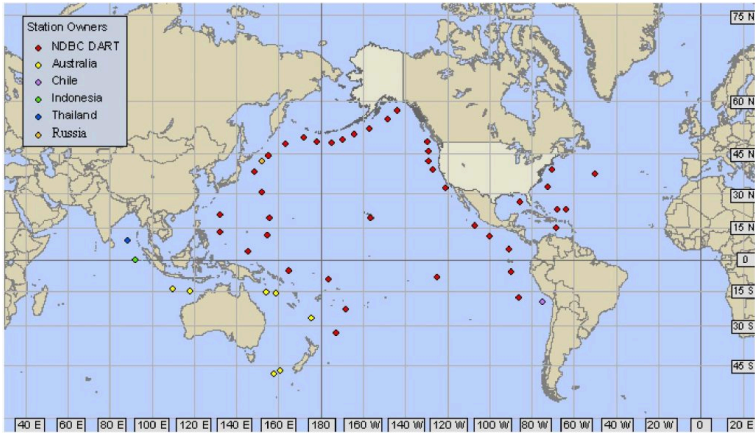

Fig. 9-12. Distribution of DART buoys in Pacific Ocean at time of Tohoku-oki Earthquake in northeast Japan.

When a subduction-zone earthquake of moment magnitude 7.5 or larger strikes anywhere around the Pacific Ocean (magnitude 7.0 or larger on the Aleutian Subduction Zone), the tsunami warning centers swing into action. After the epicenter of the earthquake has been located from the seismic network (commonly within a few minutes) and the earthquake is confirmed as shallow, rupturing the subduction zone, the travel time of a potential tsunami is estimated, and stations near the epicenter are alerted. A tsunami warning is issued to all communities within three hours of the first wave. For communities three to six hours away from the first wave, a tsunami watch is established. For coastal regions that are still farther away, an advisory bulletin is issued and is updated as more information

becomes available, such as confirmation of a tsunami by observers, tide gauges, or deep-sea DART pressure gauges. For the West Coast, the tsunami warning would come from Palmer, Alaska. As the tsunami advances, its progress is monitored, and the warning is updated with new projected arrival times of waves and possible wave heights. This gives time for local authorities to order evacuation of low-lying areas. If a tsunami warning is issued for Hawaii, evacuation of low-lying areas is mandatory, but in other states, the decision to evacuate is made by local authorities.



9-13. Tsunami of March 11, 2011. Darker colors indicate higher waves. DART buoys also located. This map makes the point that tsunami wave heights in the open ocean are variable, depending on the configuration of the sea floor.

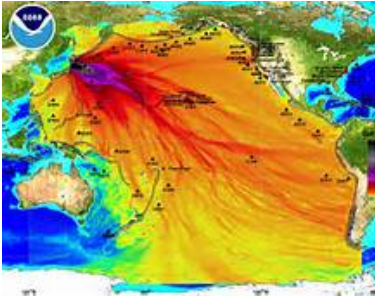

Figure 9-14. Tsunami wave heights from the Tohoku-oki earthquake of March 11, 2011. Darker colors indicate higher wave heights. Note location of DART buoys. Source: NOAA.

Computer modeling of tsunamis gives more confidence to the warnings, although modeling is not yet used by the tsunami warning centers in issuing warnings or alerts. This might change, because models can take into account the strong directivity of tsunamis (Figures 9-13, 9-14). It's

important to learn not only the location of the epicenter and the magnitude of an earthquake, but also the direction of motion of the ocean floor, which can be determined by studying the wave forms of seismograms of the mainshock recorded at many seismograph stations. Armed with such information, the warning of the 1964 Alaska tsunami could have been more strongly directed to the west coast of North America and less toward Japan, which recorded the tsunami but suffered no damage.

A tsunami wave was once compared to the waves in a pond radiating out from a pebble that is thrown into it, with the pebble representing the earthquake. The directivity of a tsunami leads to a better analogy. It's more like throwing a log into the water; waves in front of the log are much higher than the waves at the ends.

Tsunami warning systems worked well for two

distant tsunamis that traveled great distances: the tsunamis of 1952 and 1957. But they were of limited value in saving lives from the 1960 Chile tsunami that traveled from Chile to Japan, and the 1964 Alaska tsunami that did damage as far away as southern California. Furthermore, more than 75 percent of the tsunami warnings have been false alarms. Nevertheless, a partnership among the USGS, NOAA, and the five western states called CREST (Consolidated Reporting of Earthquakes and Tsunamis) has reduced the response time from more than ten minutes to less than two minutes for the 2001 Nisqually Earthquake.

What about warnings to coastal areas when the earthquake occurs on a fault that is just offshore? Tsunami warnings were of no use to towns in southern Alaska struck by the 1964 tsunami. How about an earthquake on the Cascadia Subduction Zone or on the Seattle Fault in Puget Sound? There is little time—perhaps less than ten or fifteen minutes—before the first wave reaches the coast (Figure 9-13). A tsunami struck Okushiri Island off the northwest coast of Japan only two to three minutes after a large offshore earthquake, killing schoolchildren on the beach.

The best advice now for regions subjected to subduction-zone earthquakes is to get to high ground immediately when the shaking from a great earthquake stops long enough to allow one to move. Don't wait for a tsunami warning. The Cascadia tsunami off the Oregon coast will arrive within 20 minutes of strong ground motion.

Some earthquakes generate tsunamis that are unusually large for the amount of shaking they cause. This can happen for two reasons. Some earthquakes are characterized by motion of the ground that is so slow that little shaking damage occurs, even though the earthquake magnitude is large. A slow earthquake in Nicaragua on September 2, 1992, produced a tsunami that killed hundreds of coastal villagers, even though the amount of shaking was deceptively small. If a slow earthquake struck a coastal area, people might not take seriously the tsunami potential of the earthquake seriously until it was too late.

The second reason is that an earthquake can trigger a submarine landslide. On July 17, 1998, more than twenty-two hundred villagers along a fifteen-mile stretch of the north coast of Papua New Guinea lost their lives in a tsunami that was generated by an earthquake of M 7.1. The earthquake apparently caused a submarine landslide, and the earthquake and landslide together produced a tsunami with wave heights of thirty to forty-five feet. The tsunami arrived about twenty minutes after the earthquake. In contrast to the long periods of tsunamis from a distant source, the Papua New Guinea tsunami had wave periods of one to five minutes. Landslide-generated tsunamis are of particular concern to the Pacific Northwest; huge landslides off the southern Oregon coast mapped by Chris Goldfinger probably generated large and devastating tsunamis.

In the 1964 Alaska Earthquake, Seward and Valdez

were hit by tsunamis from two different sources. The first one was triggered by submarine landslides immediately offshore, extending onshore and causing collapse of the waterfronts of both towns. In some areas, waves began to strike less than sixty seconds after the beginning of the earthquake, while strong shaking was still going on. The landslide-generated tsunamis caused the largest waves, more than one hundred sixty feet high at Valdez, with waves bouncing off the sides of the narrow bays leading into the towns for ten to fifteen minutes. Then, about fifteen minutes after the beginning of the earthquake, the tectonic tsunami arrived, generated by the sudden change in depth of the sea floor in Prince William Sound. The tsunamis were worse because both towns are at the heads of narrow fjords. This concept is illustrated for Cascadia in Figure 9-13. One set of tsunamis heads toward the Northwest coast, taking about 15 to 20 minutes after the earthquake to arrive. The other set heads west into the Pacific Ocean, arriving in Japan and other areas several hours later, allowing a warning to be issued for Japan.

The 1992 Cape Mendocino Earthquake generated a small tsunami that arrived at Eureka twenty minutes after the earthquake and at Crescent City forty-seven minutes after the quake. Waves continued to arrive for about ten hours, with the strongest waves eighteen inches high at Crescent City almost four hours after the earthquake.

As was shown in the 1964 tsunami, a warning system

needs more than notification by radio. A siren system would wake people up if the tsunami struck at night, as it did in 1964. The siren at Copalis Beach, Washington, probably saved lives in 1964. However, a siren might be knocked out by a local earthquake. Crescent City now has a siren, but it will be activated for distant tsunamis only. If a siren system is proposed for your community, make sure that funds are provided to maintain and test it, including funds for an emergency generator.. The county emergency manager (see Chapter 14) is a logical person to be responsible for a siren system.

## 6. Tsunami Hazard Maps

Following the 1992 Cape Mendocino Earthquake, the California Governor's Office of Emergency Services and the Federal Emergency Management Agency (FEMA) funded a study of the effects of an earthquake of M 8.4 on the Cascadia Subduction Zone for the 150-mile distance across Humboldt and Del Norte counties between Cape Mendocino and Cape Blanco, Oregon. This was published by the California Division of Mines and Geology as Topozada et al. (1995). As part of this scenario, NOAA produced tsunami inundation studies of the Crescent City and Humboldt Bay areas. In the scenario, the tsunami arrived just minutes after the earthquake, which meant that there was not enough time to order an evacuation. Waves were higher than



thirty feet. The Samoa Peninsula was inundated, as was the village of King Salmon, which faces the opening of Humboldt Bay. Earthquake damage to road approaches would prevent immediate aid from reaching the Samoa Peninsula. A possible refuge for residents would be a ridge of wooded dunes just west of Manila, two miles north of Samoa and four miles north of Fairhaven. At Crescent City, the scenario tsunami runup was higher than the 1964 tsunami, with severe damage expected in the developed area along the shoreline south of Front and M Streets.

In October 1994, Senator Mark Hatfield of Oregon asked for a report on preparedness against tsunamis, especially a tsunami generated on the Cascadia Subduction Zone. A year later, the Senate requested a plan for implementation with a budget. This led to the establishment in December 1996 of the National Tsunami Hazard Mitigation Program for the five Pacific Coast states, under the direction of NOAA and in collaboration with FEMA and the USGS. This



Figure 9-15a. Tsunami inundation map of Newport, Oregon, with areas subject to inundation marked in orange. Unfortunately, the NOAA tsunami research center at Hatfield Marine Science Center is within the inundation area on the south side of Yaquina Bay. Map courtesy of NOAA and Oregon Dept. of Geology and Mineral Industries; larger versions available online.

program, with a budget of about \$2 million per year, supports tsunami inundation modeling in states bordering the Pacific Ocean, tsunami mitigation activities, upgrading seismic networks, and deep-ocean pressure gauges. As part of this program, the Center for Tsunami Inundation Mapping Efforts (TIME) was established at NOAA's laboratory at the Hatfield Marine Science in Newport, Oregon. Research is underway to improve and integrate tsunami modeling with real-time

observations. Tsunami inundation maps are constructed using computer models of the earthquake source as well as the configuration of the continental slope and shelf and coastal bays, harbors, and estuaries. The tsunami maps show where tsunamis are likely to be focused, such as they were at Hilo, Hawaii and Crescent City, California.

During the first year of the program, all of the mapping funds went to Oregon and Washington, with tsunami maps at Newport, Cannon Beach, and Arch Cape, Oregon (Figure 9-15a, b). In 1995, Oregon enacted legislation that limits construction of new essential facilities and special-occupancy structures in tsunami flooding zones, although the NOAA research lab investigating tsunamis at the Hatfield Marine Science Center is, unfortunately, within the tsunami inundation zone. Directed by this new law, the Department of Geology and Mineral Industries (DOGAMI) prepared a series of tsunami hazard maps at a scale of one inch to 2,000 feet of the entire Oregon coast (available as Open-File Reports O-95-09 through O-95-66 and explained in O-95-67, which also contains an index map of the individual tsunami warning maps). If you live at the coast, you can obtain a map of your area from DOGAMI.

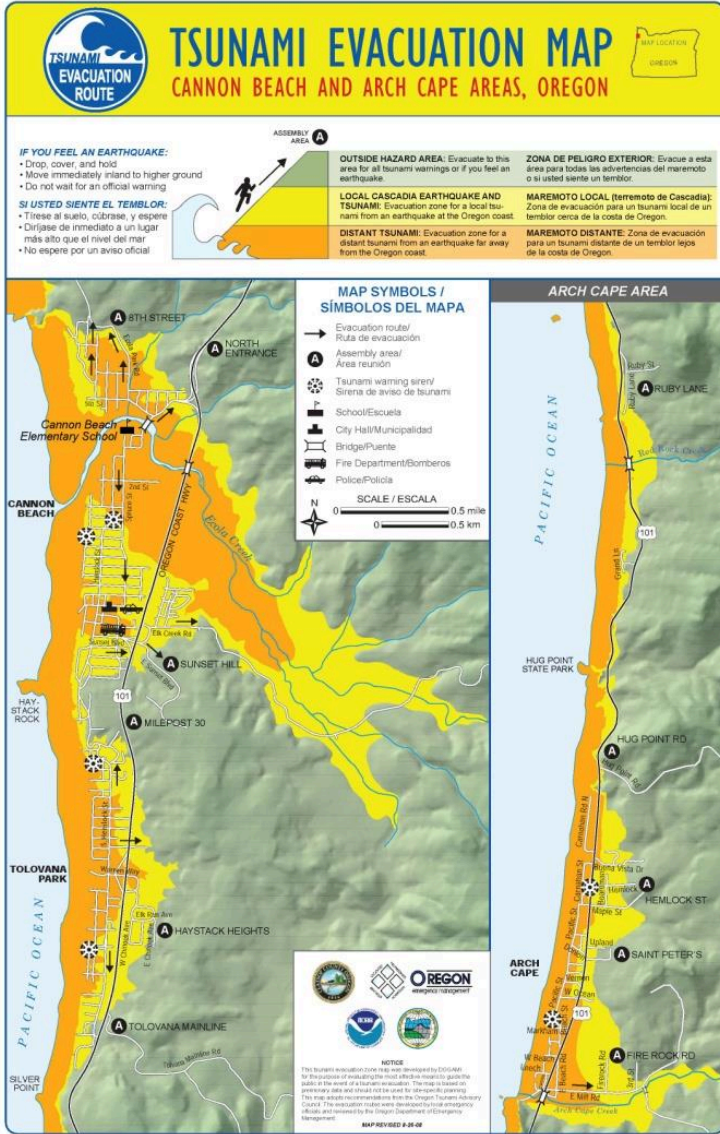

Figure 9-15b. Tsunami inundation map of Cannon Beach and Arch Cape, Oregon. Arrows show evacuation routes.

In the 1990s, DOGAMI designed a tsunami warning logo to be posted on Oregon beaches. This logo (Figure 9-16) now has been adopted around the world. The tsunami logo is seen along Highway 101 where the road drops in elevation to within the tsunami runup zone. Evacuation routes are identified by the logo and an arrow showing which direction to evacuate. At my condo at Nye Beach in Newport, we designed an evacuation map that is posted in all condo units, including the instructions to not depend on elevators or your car to get you away from the inundation zone. OSU has an extension agent, Pat Corcoran, who lives at the coast and has the responsibility of informing the public about tsunami hazards.

The National Tsunami Hazards Mitigation Program supported the preparation of a tsunami hazard map of the southern Washington coast from Taholah, north of Pt. Grenville, to the Columbia River. As in Oregon, the location of maximum tsunami runup is based on computer models including the topography of the seafloor. This study also estimated the time of arrival of the first large tsunami: thirty minutes or less for communities directly facing the Pacific Ocean like Taholah, Long Beach, and Westport, but at least an hour for communities within Grays Harbor or Willapa Bay, including Aberdeen, Hoquiam, and Bay Center. NOAA is also preparing scenarios for a tsunami following an earthquake on the Seattle Fault, which would produce large waves in Elliott Bay in downtown Seattle.

What warning should be given to coastal residents in

case of an earthquake? On the Oregon and Washington coast, strong shaking is likely to mean an earthquake on the subduction zone, and residents are advised to evacuate to higher ground without waiting for a tsunami warning. But what about crustal earthquakes that do not generate tsunamis? The city of Santa Cruz, California, underwent strong shaking during the 1989 Loma Prieta Earthquake, and Santa Monica was damaged by the 1994 Northridge Earthquake; neither earthquake generated a tsunami. Should the residents evacuate without official notice in earthquakes like those? Probably not. Even the 1906 San Francisco Earthquake, which had its epicenter offshore west of the Golden Gate, did not generate a tsunami large enough to warrant evacuation.

Attention has also been given to locations where residents would not have time to evacuate to high ground. At Cannon Beach, for example, a stream lies between the beach and high ground (Figure 9-15b). Evacuation drills have suggested that fifteen or twenty minutes would not be enough time to get everyone to high ground, particularly people with disabilities. The bridges would be jammed with cars. In this case, an alternate option is vertical evacuation: to the upper floors of beachfront hotels. Figure 9-17 shows an alternative: put your beachfront home on stilts! An Oregon coastal town proposed a new city hall using this principle, but the decision makers were unable to follow through with raising the money to do it.

## 7. Seiches

A fascinating subculture in Seattle and, to a lesser extent, in Portland, comprises people who live on the water in houseboats, with the largest number on Lake Union in Seattle. This is not inexpensive living; recent real-estate listings were from half a million to nearly a million dollars for a floating home. There are enough houseboaters to have their own neighborhood community council called the Floating Homes Association. People who live on dry land are known as “uplanders.”

On a sunny Sunday afternoon, November 3, 2002, Ed Waddington was on the second floor of his floating home on Lake Union reading the newspaper when his boat began to move and rock. The usual reason a houseboat starts to rock is a passing boat

exceeding the speed limit of seven knots, but the rocking motion continued for at least five minutes, too long for a boat wake. Log rafts on which houseboats are built were bashing into one another and into piers, and chains were snapping taut. Waddington walked to the end of his pier, where he and several of his neighbors



Figure 9-16. Internationally recognized tsunami warning logo.

flagged down a police boat. The police officer told him that he had been dispatched by the Harbor Patrol base on Northlake Way to look for speeders. But there were none.

Waddington turned on his radio and heard a report of an earthquake in central Alaska, the Denali Earthquake, of magnitude 7.9. As a professor in the Department of Earth and Space Sciences at the University of Washington, he put two and two together and recognized that the houseboats in Lake Union were feeling the Denali Earthquake thousands of miles away. Surface waves from this earthquake with a period of about twenty seconds were strong enough to cause the sloping lake bottom to move, so that the water sloshed and produced damaging surface waves, but these surface waves were too slow to be felt by the “uplanders.” At least twenty houseboats were damaged.

Sloshing water was reported elsewhere, including a five-foot wave at Lake Wenatchee, and high waves on Puget Sound, Lake Washington and on Henry Hagg Lake, Oregon. Both Ross Lake and Lake Chelan in Washington were affected. Water sloshed out of swimming pools. According to Aggeliki Barberopoulou, then of the University of Washington, the concentration of damage at Lake Union and Portage Bay was due to the focusing of seismic waves by the thick Seattle sedimentary basin underlying Lake Union, in addition to the large number of houseboats around the lake.

Barberopoulou’s conclusion is supported by reports



of a seiche on Lake Union after the 1964 Alaska Earthquake. About 7:45 in the evening of March 27, 1964, houseboats broke away from their moorings, and water pipes were broken. The north mooring line of the Four Winds Restaurant pulled a piling from the lake bottom, and fifty-five patrons had to be evacuated. Bartender Paul Farris reported a lot of broken glasses. At Aberdeen, on the Washington coast, water sloshed out of the city reservoir and carried gravel into a nearby neighborhood.

---

### *Suggestions for Further Reading*

- Atwater, B.F., et al.,2005. The orphan tsunami of 1700 – Japanese clues to a parent earthquake in North America. U.S. Geological Survey Professional Paper 1707, 133 p. <http://pubs.usgs.gov/pp/pp1707/>
- Atwater, B. F., V. M. Cisternas, J. Bourgeois, W. C. Dudley, J. W. Hadley, and P. H. Stauffer, compilers. 1999. Surviving a Tsunami—Lessons Learned from Chile, Hawaii, and Japan. U.S. Geological Survey Circular 1187. 18p.
- Barberopoulou, A., A. Qamar, T. Pratt, K. Creager, and W. Steele. 2003. Local amplification of seismic waves from the MW 7.9 Alaska earthquake and a damaging seiche in Lake Union, Seattle, Washington.

- Geophysical Research Letters, DOI: 10.1029/2003GL018569.
- Benson, B., K. A. Grimm, and J. J. Clague. 1997. Tsunami deposits beneath tidal marshes on northwestern Vancouver Island, British Columbia. *Quaternary Research*, v. 48, p. 192-204.
- Bernard, E. N., et al. 1991. *Tsunami Hazard: A Practical Guide for Tsunami Hazard Reduction*. Dordrecht, The Netherlands: Kluwer Academic Publishers.
- Clague, J. J., A. Munro, and T. Murty. 2003. Tsunami hazard and risk in Canada. *Natural Hazards*, v. 28, p. 433-61.
- Darienzo, M. 2003. The National Tsunami Hazard Mitigation Program. *Earthquake Quarterly*, Summer 2003, published by the Western States Seismic Policy Council, p. 4-7, 17.
- Dudley, W. C., and M. Lee. 1988. *Tsunami! Honolulu: University of Hawaii Press.*
- Governor's Office of Emergency Services. 1996. *Tsunami! How to survive the hazard on California's coast*. Free pamphlet available from OES.
- Hawaii State Civil Defense. 2002. *Tsunami: Waves of Destruction*. 30-min. and 15-min. videos.
- Henderson, B., 2014, *The next tsunami: Living on a restless coast*: OSU Press, 322 p.
- Humboldt Earthquake Education Center. 1999. *Living on shaky ground: How to survive earthquakes and tsunamis on the north coast*.
- Nance, J. J. 1988. *On Shaky Ground*. New York: William

- Morrow & Co., 416p. Description of the 1964 tsunami in Alaska.
- National Tsunami Hazard Mitigation Program (NTHMP). 2001. Designing for tsunamis: background papers. 122 p. , 60 p. Seven principles for planning and designing for tsunami hazards.
- Oregon Department of Geology and Mineral Industries. 2001. Tsunami warning systems and procedures: Guidelines for local officials. Special Paper 35, 41 p.
- Preuss, J., and G. T. Hebenstreit, G.T. 1998. Integrated tsunami-hazard assessment for a coastal community, Grays Harbor, Washington. USGS Professional Paper 1560, p. 517-36.
- Toppozada, T., G. Borchardt, W. Haydon, M. Petersen, R. Olson, H. Lagorio, and T. Anvik. T. 1995. Planning scenario in Humboldt and Del Norte counties, California, for a great earthquake on the Cascadia Subduction Zone. California Division of Mines and Geology, Special Publ. 115. 157p.
- Walsh, T. J., C. G. Caruthers, A. C. Heinitz, E. P. Myers, III, A. M. Baptista, G. B. Erdakos, and R. A. Kamphaus. 2000. Tsunami hazard map of the southern Washington coast: modeled tsunami inundation from a Cascadia Subduction Zone earthquake. Washington Division of Geology and Earth Resources Geologic Map GM-49, booklet, 12 p.



## PART IV

# PART IV: PREVENTION AND COUNTERMEASURES

It's one thing to be convinced that earthquakes are a threat. We face dangers from ground shaking, landslides, liquefaction, tsunamis, and surface rupture. But what can we do about it?

The chapters that follow describe the human response to earthquakes at every level, from the federal government to the individual. Should we purchase earthquake insurance? If so, it might be useful to learn about the problem from an insurance company's point of view, which means we need to learn about risk. The cost of your insurance may be influenced by the actions you take as a homeowner or renter to make your house more secure against earthquakes. These actions can also save your life or prevent serious injury during an earthquake. How about the safety of the building where you work, or the bridge you must cross on the way to work, or the dam upstream from your home?

The government is involved at all levels—federal, state, and local. Much of the research on earthquakes and on earthquake engineering is funded in the United States by the federal government, and we turn to the

federal government for help in a disaster. State and provincial governments are involved in a major way in earthquake hazard reduction, spurred on by the havoc earthquakes have raised in the past. However, Oregon and Washington have not yet made a major financial commitment toward earthquake hazard mitigation, although cities such as Seattle and Bellevue have done so. Building codes and grading ordinances, where they are in effect, give us some security that the structure we live or work in will not collapse during an earthquake, or that the ground on which that structure is built will remain stable during an earthquake. But builders ,developers, and chief executive officers sometimes resist such laws because they increase their cost of doing business.

Finally, what should each of us do to plan against an earthquake?

# 10. Earthquake Insurance: Betting Against Earthquakes

*“What would happen if someone discovered how to predict earthquakes? No more earthquake insurance.”*

Richard J. Roth, Jr., California Department of  
Insurance, 1997

## I. Some Philosophical Issues

Should you buy earthquake insurance for your house? For your business? Before addressing these questions directly, let's take a look at insurance in general and then at the particular problems in insuring against earthquakes.

You own a house, and you don't want to lose it in a fire, a flood, or an earthquake. You might take chances on the little things in life, but not your home; there's too much at stake. Fortunately, you are contacted by a company that offers to take the risk for you—at a price. The company is gambling that it can assume the risk of

the loss of your house, and the houses of a lot of other people, and the price it gets for doing so will allow it to make money. The company is not offering you charity, but a business deal in which it expects to earn a profit. This doesn't bother you if the insurance is affordable, because you figure that the price you have paid is worth not having to worry about losing your home.

The company that takes on the risk is an *insurance company*, and the price you have paid is called the *premium*. The danger you are insuring against—fire, hurricane, or earthquake—is called a *peril*. An earthquake is often referred to in other contexts as *ahazard*, but the insurance industry defines “hazard” as something that makes your danger worse, like failing to reinforce your house against an earthquake, or allowing dense brush to grow against your house so that it is more vulnerable to summer wildfires.

The company sells you fire insurance or automobile insurance, betting that your house won't burn down or you won't wreck your car so that the company can keep your premium and make money. The company wins its bet when your house doesn't burn down and you don't wreck your car. You read about house fires almost every day in the newspaper, and thousands of people die in traffic accidents, but enough people pay fire and auto insurance premiums that the insurance company can cover its losses and still make money.

The insurance company wants to charge you a premium low enough to get your business, but high enough that it can make money after paying off its



claims. It can do this because it calculates approximately how many house fires and auto accidents it is likely to have to pay off during the premium period. The larger the number of contracts it writes, the more likely the actual results will follow the predicted results based on an infinite number of contracts—a statistical relationship known as the *Law of Large Numbers*.

But suppose that an evil spirit casts a spell on automobile drivers so that instead of the usual number of auto accidents, there are hundreds of times more. Or an army of arsonists goes around setting houses on fire. The claims on the insurance company would be many times more costly than the number the company had figured on when it calculated premiums, and it would lose money. It could even go broke.

In a way, this is what an insurance company faces in a large urban earthquake, and indeed in any natural catastrophe, such as Hurricane Andrew in Florida or Tropical Storm Sandy in New York and New Jersey. The difference is that the insurance company is dealing not with claims from a large number of individual automobile accidents or house fires, but from a single gigantic “accident”—an earthquake or a hurricane. The losses from the 1994 Northridge Earthquake were \$20 billion, and those caused by the Kobe Earthquake were as high as \$200 billion.

A large, destructive earthquake is an extremely rare event in any given place, and most of the time the insurance company collects your earthquake-

insurance premium and makes money. But when an earthquake finally strikes a big city, the losses could be so great as to bankrupt the company. If earthquake scientists could finally get it right and make accurate probabilistic forecasts of when, where, and how large an earthquake will be (see Chapter 7), then the company could charge a premium high enough to keep it from bankruptcy, even from a rare catastrophic event. But, unlike the situation with fire and auto insurance, the insurance industry lacks enough reliable information on catastrophic events to estimate its possible losses, and therefore to set a realistic premium. The losses from an earthquake might be so high that the premiums necessary to stay in business would be prohibitively expensive, discouraging homeowners from buying earthquake insurance at all.

Consider the earthquake losses from the great San Francisco Earthquake of 1906. (The dollar figures are small, but so was the size of the insurance industry at that time.) The Fireman's Fund Insurance Company found that it was unable to meet its loss liabilities of \$11,500,000, and it closed down to be reformed as a new company, paying off claims with 56.5 percent cash and 50 percent stock in the new company. Four American and two British companies, including Lloyds of London, paid their liabilities in full, but forty-three American and sixteen foreign companies did not, spending months and years in legal battles to avoid paying off their claims. Four German companies immediately stopped doing business in North America to avoid

paying anything. Another offered to pay only a fraction of its losses.

The insurance industry had underestimated its potential losses in a catastrophic earthquake. The premium was not *cost-based*.

This is why the debate about whether the next Cascadia Subduction Zone earthquake will be a magnitude 8 or 9 is being followed with nervous fascination by the insurance industry. Insurance companies have no problem with a Nisqually Earthquake, not even with several Nisqually Earthquakes. It might even handle a magnitude 7.9 earthquake on the central San Andreas Fault in the thinly populated California Coast Ranges. But a magnitude 9 on the subduction zone, or even a magnitude 7.1 on the Seattle Fault gives insurance underwriters fits. Can the insurance industry survive a magnitude 9 on the Cascadia Subduction Zone and still stay in business and meet its obligations? Can it survive two urban earthquakes, one in Seattle and one in Portland, back to back?

## **2. A Brief Primer on Insurance**

Insurance is our social and economic way of spreading the losses of a few across the greater population. We are pretty sure our house won't burn down, but we buy fire insurance for the peace of mind that comes from

knowing that on the odd chance that it does burn down, our investment would be protected. Our insurance premium is our contribution to setting things right for those few people whose houses do burn down, since the house that burns down could be our own.

Insurance is a business, but it's also a product. There is a consumer's market, insurance has value, and the product has a price—called the premium. But insurance differs from other products in that its cost to the company is determined *only after it is sold*. For this reason, the company tries hard to estimate in advance what that cost is likely to be.

For an insurance company to stay in business, it must be able to (1) predict its potential losses, (2) calculate a price for premiums that will compensate for its losses and allow it to make a profit, (3) collect the premium, and (4) pay off its claims as required in the insurance contract. The company has an executive department that determines overall corporate direction (including the basic decision about whether or not the company wants to be in the earthquake insurance business at all), a department that sends out your statement, a department that settles your claim, and a department that worries about risk so that the price of the premium fits the risk exposure of the company. This last process, called *rating*, is done by an *actuary*. To determine a rating for earthquake insurance for your house, the actuary may take into account the quality of construction, its proximity to known active faults, and the ground conditions. *Underwriting* is the

determination of whether to insure you at all. The underwriter uses the rates established by the actuary and accepts the risk by establishing the premium. For example, if you are an alcoholic and have had several moving automobile violations, including accidents that were your fault, the underwriter might refuse you automobile insurance at any price. If a decision is made to insure you, the underwriter would establish the premium and deductible appropriate to the company's risk exposure.

An insurance company has *reserves*, money for the payment of claims that have already been presented but have not been settled, probably because the repair work has not yet been completed or the claim is in litigation. Reserves are not available for future losses; these losses show as a liability on the company's books. A *policyholder surplus*, or *net worth capital*, or *retained earnings* are funds that represent the value of the company after all its liabilities (claims) have been settled. This is the money available to pay for future losses.

It turns out that the insurance company, too, wants to hedge its bets against the future by transferring part of its risk to someone else. To meet this need, there are insurance companies that insure other companies—a process called *reinsurance*. Let's say that the original company insures a multimillion-dollar structure but wants to spread the risk. So it finds another company to share that risk, and that company—a reinsurance company—then receives part of the premium. It might

well be the reinsurance industry that is most interested in the results of scientists and engineers in earthquake probability forecasting and in assessing ground response to earthquake shaking.

Some say that even the reinsurance industry would be unable to pay all claims arising from a catastrophic M 9 earthquake on the Cascadia Subduction Zone, and only the federal government, with its large cash reserves, can serve as the reinsurer of last resort. I return to this question later in the chapter.

We start with that which insurance does best: insure against noncatastrophic losses such as auto accidents, fires, and death. These are called *insurable risks*. The loss must be *definite, accidental, large, calculable, and affordable*. Enough policies need to be written so that the Law of Large Numbers kicks in. The *principle of indemnity* (which excludes life insurance, of course) is to return the insured person or business to the condition that existed prior to the loss. This means replacing or repairing the property or paying out its value as established in the insurance contract. The contract might include both *direct coverage*, replacing the property that was damaged or destroyed, and *indirect coverage*, taking care of the loss of income in a business or loss of use of the property. Protection against liability might be included. The contract commonly contains a *deductible clause*, which states that the insurance company will pay only those losses exceeding an agreed-upon amount. The higher the deductible, the lower the premium. This reduces the

risk exposure for the company and reduces the number and paperwork of small claims submitted.

The underwriter has calculated the exposure risk using the Law of Large Numbers. A lot of historical information about fire and auto accident losses is available, so the risk exposure is calculable; that is, the underwriter can recommend premium levels and types of coverage with considerable confidence that the company will be able to offer affordable coverage and still make a profit. The underwriter also looks for favorable factors that might reduce the risk. For fire insurance, a metal roof and vinyl siding would present less risk than a shake roof and wood siding. Auto insurance might include discounts for non-drinkers or for students with a grade-point average of B or better. The underwriter also looks for general trends, like the effect of a higher speed limit on auto accident risk (increasing risk exposure), or of laws requiring seat belts and child restraints in automobiles (reducing risk exposure).

### 3. Catastrophe Insurance

Insurance against natural catastrophes is much more complex and much less understood, and a large company might employ engineers, geologists, and seismologists to help it calculate the odds. The insurance market in California changed drastically after

the 1989 Loma Prieta Earthquake and the 1994 Northridge Earthquake. If a magnitude 9 earthquake struck the Cascadia Subduction Zone, the devastation would spread across a large geographic area, including many cities and towns. As a result, an insurance company would have a large number of insured customers suffering losses in a single incident, thereby defeating the Law of Large Numbers. Potential insurance losses after a major earthquake determine *insurance capacity*.

Insurance capacity is in part controlled by the fact that all the insurance companies in a region can write only so much insurance, controlled by their financial ability to pay the claims. (This is not the same as *insurance surplus*, which is simply assets minus liabilities.) Part of the role of the executive department of an insurance company is to decide how to distribute its surplus among different kinds of losses. For example, an insurance company might be so concerned about the uncertainties in writing earthquake insurance that it is only willing to risk, say, 10 percent of its surplus—which then defines its capacity for earthquake insurance. It could sustain losses in a major urban earthquake but risk a small enough percentage of its total coverage that it would not go out of business.

In making its decision about capacity, the company estimates its *probable maximum loss (PML) exposure* to earthquakes, meaning the highest loss it is likely to sustain. If the company finds that its estimated PML is too high, it reduces its capacity for earthquake



insurance in favor of noncatastrophic insurance, thereby reducing its PML exposure. The company might decide to get out of the earthquake insurance business altogether. Insurance capacity was reduced after the losses following the 1994 Northridge Earthquake; there was too much uncertainty in figuring out the risk.

After a major earthquake, the capacity becomes reduced at the same time the demand increases for earthquake insurance. This creates a seller's market for the underwriter, who can set conditions more favorable to the company. These conditions might include the stability of the building site, the proximity to active faults, the history of past earthquakes, and the structural upgrading of the building to survive higher earthquake accelerations. If you are a building owner, your attention to these problems can have an economic payoff in lower earthquake insurance rates, just as a good driving record can lower your automobile insurance premium.

Just as health insurers prefer to insure healthy people, earthquake insurers prefer properties that are most likely to survive an earthquake. Your premium will be higher (or you might be uninsurable) if your house is next to the San Andreas Fault. If your building is constructed on soft sediment of the Duwamish River in Seattle or on beach deposits along the coast, which might liquefy or fail by landsliding, your premium might be higher than if you had built on a solid rock foundation. Unfortunately for the insurance company,

people living next to the San Andreas Fault or on unstable sediments in an earthquake-prone region such as the San Francisco Bay Area are more likely to buy earthquake insurance than people living in, say, Spokane or Medford, not known for large earthquakes. This is called *adverse selection*.

The result is that the risk of earthquake damage is not spread over a large enough group of people. This makes earthquake insurance more expensive for everybody and causes people either to refuse to buy earthquake insurance or drop their existing coverage.

Maps of the Portland, Salem, Eugene, and Victoria metropolitan areas showing regions susceptible to liquefaction and landsliding related to earthquakes were designed to highlight those areas where the danger from earthquakes might be much greater than other areas. Liquefaction maps of Seattle and Olympia were a good predictor of areas of liquefaction damage in the Nisqually Earthquake (Fig. 8-16). It's possible to superimpose on such maps an overlay of building types classified by their vulnerability to earthquakes.

An insurance company asked to insure a large building in one of these areas could use these maps to set the premium, but Proposition 103, passed by California voters in 1988, requires all insurance companies to get their rates approved by the Department of Insurance. Once a rate for a particular class of risk has been filed with and approved by the Department of Insurance, the insurance company may not deviate from this rate. The company would have to

request a deviation from the approved rate based on new information contained in a hazard map.

Insurance underwriters are very much aware that the principal damage in an earthquake is to buildings that predate the upgrading of building codes. They know that buildings constructed under higher standards are more likely to ride out the earthquake with minimum damage. Therefore, your premium might be lower (or your building might be insurable) if it's constructed or retrofitted under the most modern building codes, thereby reducing the risk to the company as well as to yourself.

From an insurance standpoint, building codes are a set of minimum standards, and these standards are designed for *life safety* rather than *property safety*. The building code works if everybody gets out of the building alive, even if the building itself is a total loss. If your structure has been engineered to standards much higher than those required by the code, so that not only the people inside but also the property itself survives, your insurance premium could be significantly lower. You would need to determine whether the reduced premium more than offsets the increased construction costs or the retrofit costs necessary to ensure that your building is usable after the earthquake.

The insurance company can reduce its PML exposure by establishing a high deductible. A common practice is to express the deductible as a percentage of the value of the covered property at the time of loss. For example, your house is insured for \$200,000 and your deductible

is fifteen percent of the value of the house at the time of loss. An earthquake strikes, and damage is estimated at \$50,000. Fifteen percent of \$200,000 is \$30,000, so the insurance company pays you \$20,000, the difference between the deductible and the estimated damage.

Now we get into some gray areas. First, liability insurance. Suppose the owner of the building where you work or rent your apartment has been told that the building is not up to earthquake code but chooses not to retrofit. An earthquake destroys the building, and you are severely injured. Do you have a negligence claim against the building owner that his liability insurance would be required to pay off?

Another gray area is government intervention. A major catastrophe such as the Nisqually Earthquake brings immediate assistance from the Federal Emergency Management Agency (FEMA), including low-interest loans and direct assistance. The high profile of any great natural catastrophe—a hurricane as well as an earthquake—makes it likely that the president of the United States, or at least the director of FEMA, will show up on your doorstep. Billions of dollars of federal assistance might be forthcoming, although this is generally a one-shot deal—aid that is nonrecurring. However, major transportation systems and utilities—called lifelines—will be restored quickly. After the Northridge Earthquake, the highest priority was given by Caltrans to reopen the freeways, and Southern California Gas Company quickly repaired a ruptured gas trunk line on Balboa Boulevard in the San Fernando

Valley. After Nisqually, Sea-Tac Airport and Boeing Field were soon placed back into service.

The net effect of this aid is to compensate for the large losses in the affected region, although not necessarily the losses of insurance companies. This aid follows the insurance principle that losses are spread across a larger population—in this case, the citizens of a state and the United States. However, much of this aid focuses on relief rather than recovery. The delivery of aid after Hurricane Sandy was poorly organized in New York and New Jersey in that Congress dithered in funding recovery for several months, and today there are still major legal problems in recovery from that storm, including conflicts between homeowners and government agencies as well as with insurance companies.

## 4. Government Intervention

State governments have already intervened in the insurance business, thanks to the McCarran Ferguson Act of 1945. The state insurance commissioner must approve the rates charged by an insurance company within the state and must monitor the financial strength of a company and its ability to pay its claims. An *admitted* insurance company is licensed by the insurance commissioner to do business in the state. *Nonadmitted* companies not licensed by the insurance

commissioner can do business only through *surplus line brokers*.

The state may be able to help people settle claims against an insurance company that has gone broke, but only against an admitted company. The state of Washington has a guaranty fund made up of payments by all admitted companies based on a percentage of their total premiums. This is administered by a private corporation governed by a board made up of insurance executives. The monetary payment limit is \$300,000 with a deductible of \$100. Oregon has a similar law covering property losses.

People naturally distrust insurance companies. We see their gleaming downtown office buildings at the same time our premiums are increasing, or we get the runaround when we submit a claim. A state department of insurance might respond to this distrust by developing an adversarial relationship with the insurance industry within the state. Or a state insurance commissioner or state legislators might develop too cozy a relationship with lobbyists for the industry being regulated. The high cost of insurance has become a political issue—first, health insurance costs, with the political debacle over the Affordable Care Act, which prevents insurance companies from denying insurance to people with pre-existing conditions, which is analogous to being forced to offer auto insurance to bad drivers and alcoholics. In California, earthquake insurance has become more expensive under the California Earthquake Authority,

which offers less insurance for a higher premium and higher deductible. This has caused many people to drop their earthquake insurance coverage, raising the question of what to do when the earthquake destroys thousands of homes that are no longer insured. This is discussed further below.

This adversarial relationship can be a particular problem in insuring against catastrophes. The insurance industry has developed computer models to estimate its losses in a major catastrophe, models that suggest that premiums are not high enough, are not *cost based*. But these models are proprietary, meaning that an insurance company might not want to release the details of the model to the insurance commissioner and the public and lose its competitive advantage. Some state departments of insurance might not accept or trust these models, or they might regard them as biased in favor of the industry. However, this is not a problem for the California State Department of Insurance; the California Earthquake Authority, described below, uses its own computer models.

Government intervention could be taken to an extreme: the government could take over catastrophic insurance altogether, rather than merely regulating insurance at the state level. The United States government is already involved in flood insurance; a federal insurance program is administered by the Federal Insurance Administration, part of FEMA. There is also a federal crop insurance program. However, there is no federal program of earthquake insurance.

In 1987, a group of insurance-industry trade associations and some insurance companies organized a study group called the Earthquake Project to consider the effects of a great earthquake on the U.S. economy in general and the insurance industry in particular. This group, renamed the Natural Disaster Coalition after the multibillion-dollar losses from Hurricane Andrew, concluded that the probable maximum losses from a major disaster would far exceed the insurance industry's capacity to respond, and that a federal insurance partnership was necessary. The study group proposed legislation to establish a primary federal earthquake insurance program for residences and a reinsurance program for commercial properties. However, the proposal was criticized as an insurance-industry bailout, and no action was taken. A revised proposal attracted more congressional support, but the potential federal liability in the event of a great disaster doomed this proposal as well. In 1996, the Natural Disaster Coalition proposed a more modest plan that would reduce federal involvement and establish a national commission to consider ways to reduce the costs of catastrophe insurance. This failed to win sufficient White House support for adoption, but it might be considered by a future Congress.

However, the federal government does respond to disasters, and it did so after the Northridge and Nisqually earthquakes. Disaster relief is sure to be provided, but recovery from the disaster is a political issue and is fraught with uncertainties. Grants might



be available from the Federal Emergency Management Agency or the Department of Health and Human Services.

Another proposed solution is to allow insurance companies to accumulate tax-free reserves to be available to pay claims in the event of a catastrophe. Let's say that a disaster with losses of \$100 million will occur once every ten years—far in excess of the premiums expected in the year the catastrophe struck. If the insurance industry collected and accumulated \$10 million annually for ten years, then it could meet its claims in the year of the catastrophe. However, under present accounting regulations, the \$10 million collected during a year in which no catastrophe occurs must be taxed as income. For this reason, the insurance company must pay off its \$100 million losses with the \$10 million in premiums that it collected that year plus income collected earlier on which it has already paid taxes. The proposal to accumulate tax-free reserves against a catastrophe has met with enough congressional resistance to prevent it from being passed into law.

Government has become involved in earthquake insurance in California, where the state has orchestrated the establishment of a privately financed earthquake authority, and New Zealand, where the government has gotten into the insurance business directly.

# California

In California, earthquake insurance was offered even before the 1906 San Francisco Earthquake, with major problems paying claims from that disaster, as pointed out above. But since then, earthquake insurance has been profitable for the insurance industry, up until the 1989 Loma Prieta Earthquake, followed by the 1994 Northridge Earthquake. Between 1906 and 1989, claims and payments were far less than premiums, even including three large earthquakes (1971 Sylmar, 1983 Coalinga, 1987 Whittier Narrows), two of which struck densely populated areas. But the claims and payments rose dramatically from less than \$3 million for the Sylmar Earthquake to about \$1 billion for earthquake shaking damage after the Loma Prieta Earthquake. In 1989, as a result of the Loma Prieta Earthquake, claims and payments exceeded premiums for the first time since 1906.

But the 1994 Northridge Earthquake really broke the bank: about \$15.3 billion, with more than \$9 billion in insured losses to residential properties—far more than all the earthquake premiums for residences collected for decades. One insurance company severely underestimated its potential for losses from the Northridge Earthquake; it would have gone out of business except for a buyout from another carrier. If a similar size earthquake had struck a major urban area on the heels of the Northridge Earthquake, even some

major companies would not have been able to cover their losses. Northridge losses were covered in part by the use of income from investments to pay claims.

Not all of the \$15.3 billion paid out was earthquake insurance, which covers damage from shaking. About 20 percent of the loss was paid from other types of insurance, including insurance against fire, property damage and liability, commercial and private vehicle losses, loss of life, disability, medical payments, and so on.

These figures point out another trend in the earthquake insurance market: the sharp rise in insurance premiums and claims after California began to require in 1985 that a company offering homeowners' insurance must also offer earthquake insurance, although the homeowner was not required to buy it. Because the Northridge Earthquake broke the Law of Large Numbers, the insurance industry was faced with a problem larger than simply earthquake insurance—the much larger market for homeowners' insurance that had become legally linked to earthquake insurance.

After Northridge, insurance companies asked the state legislature to uncouple homeowners' insurance from earthquake insurance. The legislature refused for the reason that it would have left millions of homeowners unable to buy earthquake insurance at an affordable price. In response, insurance companies representing 93 percent of the homeowners' insurance market severely restricted capacity for not only earthquake insurance but homeowners' insurance as

well, with some companies getting out of the homeowners' insurance business altogether. Demand greatly outstripped supply, and homeowners' insurance premiums skyrocketed. In response to complaints about the high premiums, companies pointed to studies that suggested that future losses could exceed \$100 billion, losses that would bankrupt many companies. Losses of \$200 billion from the Kobe Earthquake of 1995 in Japan solidified that view, although only a small fraction of the Kobe Earthquake loss was covered by insurance. Insurance companies and homeowners took their concerns to the California legislature in Sacramento.

The legislature then established a reduced-coverage catastrophic residential earthquake insurance that would cover the dwelling but exclude detached structures. This "mini-policy" included a 15 percent deductible, \$5,000 in contents coverage, and \$1,500 in emergency living expenses. Despite strong public support, the mini-policy did not lure insurance companies back into the residential insurance market. By mid-1996, the lack of availability of residential insurance was threatening the vitality of the California housing market.

The result was the California Earthquake Authority (CEA), signed into law by Governor Pete Wilson in September 1996. In exchange for pledging \$3.5 billion to cover claims after an earthquake, insurers transferred their earthquake risk to the CEA. The CEA then bought \$2.5 billion in reinsurance—the largest single

reinsurance purchase in history. Premium payments and additional lines of credit raised the amount available to pay claims to more than \$7.2 billion, leading the CEA to claim that it can cover losses from at least two Northridge-type earthquakes. This was accomplished without the use of public funds.

Insurance companies representing more than 70 percent of the residential property insurance market agreed to participate by signing a Participating Carrier Agreement to write policies on all eligible categories in the CEA. Insurance premiums have more than doubled, and payouts are expected to be lower. One estimate for residential claims if the CEA had been in operation at the time of the Northridge Earthquake: \$4 billion less than the amount actually paid out.

The CEA earthquake insurance is the equivalent of the “mini-earthquake policy” established in 1996. The figures below are based on data soon after the establishment of CEA, with the idea that the insurance philosophy is the same although coverage, deductibles, and rates would change. Structural damage to residences is covered, with a deductible of 15 percent of the value rather than 10 percent. The state requires a minimum coverage of \$5,000 for personal property; this turns out to be the maximum coverage offered by CEA. Emergency living expenses up to \$1,500 are provided—a token payment if you lost the use of your home for several weeks. Swimming pools, fences, driveways, outbuildings, and landscaping are not covered at all. Claims are processed by individual

insurance companies and paid by the state. If the CEA ran out of money, policyholders would get only partial payment of claims, and there could be a surcharge of up to 20 percent on their policy if claims exceeded \$6 billion.

Participation by insurance companies is voluntary, but insurers representing two-thirds of the market—including the three largest insurers, State Farm, Allstate, and Farmers—are committed to the CEA. But many smaller carriers have stayed out, in part because they cannot pick and choose among the eligible risks they would cover and risks they would not cover; it's all or nothing. Using mid-1998 figures, this means that the CEA will be able to pay out only about \$7 billion instead of the \$10.5 billion estimated with 100 percent participation. Some insurance actuaries believe that the premiums are still too low to protect against catastrophic losses; that is, CEA is still not cost based. The higher cost has been criticized by consumer advocates such as United Policyholders; it has driven many homeowners away from obtaining or renewing earthquake coverage. At present, no more than 12 percent of California homeowners have bought earthquake insurance. Of these, about 70% are insured through CEA. Even so, the CEA is now the largest provider of residential earthquake insurance in the world, with more than eight hundred thousand policyholders (down from 940,000 polycyholders) and \$163 billion in insured risk. But the question remains: what will be the impact of a major urban earthquake if

fewer than 25% of homeowners are insured? Will they walk away from their damaged homes? Will the state and federal government bail them out? The number of homeowners who walked away from their homes during the recent Great Recession may represent the wave of the future.

Under the CEA, insurance premiums vary from region to region; California is divided into nineteen separate rating territories. Much of the San Fernando Valley, which suffered two damaging earthquakes in less than twenty-five years, is paying 40 percent more than most of the rest of the Los Angeles metropolitan area. But the city of Palmdale, in the Mojave Desert adjacent to that part of the San Andreas Fault that ruptured in 1857 in an earthquake of M 7.9, pays significantly lower rates than much of Los Angeles! San Francisco Bay Area residents are paying rates four-and-a-half times higher than residents of Eureka, opposite the Cascadia Subduction Zone on the northern California coast—an area that has experienced the greatest number of large earthquakes in California, and indeed, in the United States. The north coast was struck by a M 7.1 earthquake in 1992 and is at risk from an earthquake as large as magnitude 9 on the Cascadia Subduction Zone, yet the region has rates that are among California's lowest. Perhaps the lesson to be learned here is that if your area has recently had an earthquake, earthquake insurance will be very costly, but if not, earthquake insurance could be a bargain.

In other words, the insurance industry is more

sensitive to historical earthquakes and instrumental seismicity than it is to geological evidence for prehistoric earthquakes and slip rates on active faults. In terms of establishing insurance rates, the industry's dependence on previous earthquakes means it tends to look backward rather than forward.

Controversy over the great disparity in earthquake insurance rates from region to region led to a review of the CEA's probabilistic hazard model by the California Geological Survey under contract to the State Department of Insurance. Revised models will undoubtedly make regional differences in earthquake insurance rates more realistic.

The age and type of home also affect rates. The owner of a \$200,000 wood-frame house in Hollywood or Westwood in Los Angeles would pay \$540 in earthquake insurance if the house was built in 1979 or later, \$660 if the house was built between 1960 and 1978, and \$700 if the house was built before 1960—a recognition of higher construction standards in recent years. But if the house was not of wood-frame construction, the premiums would be \$960 in Hollywood. The percent damage to homes from the Northridge Earthquake was 35 percent for buildings constructed before 1970 to 20 percent for houses that had just been completed at the time of the earthquake. The differences in insurance rates recognize the value of well-constructed houses in which earthquake risks have been taken into consideration. Rates change; the



latest rates for a given area and type and age of building are available online from CEA.

If there were a major earthquake, much of the payments to homeowners would come from reinsurance that CEA has purchased. The CEA claims that its rates, averaging \$2.79 per \$1,000 of coverage statewide, are competitive with the average rates of non-CEA insurers, \$2.92 per \$1,000 coverage. CEA rates vary based on assumed risk from \$0.95 to \$4.70 per \$1,000 coverage. A better understanding of earthquake risk has led to two rate reductions; rates are now 15 percent lower than they were when CEA went into operation in 1996.

One factor affecting rates was a decision by the Internal Revenue Service that the CEA is a nonprofit organization so that premiums can accumulate without being taxed as profit in the year they are collected. The IRS ruling is based on the CEA's commitment to earthquake mitigation programs benefiting all Californians, not just those with CEA policies. In September 1999, the CEA began an earthquake mitigation program in eight Bay Area counties called State Assistance For Earthquake Retrofitting (SAFER), which includes low-cost inspections and assessments of older homes by structural engineers and low-interest loans to pay for seismic retrofits. The CEA worked with Oakland's KTVU Television to produce a public awareness program on the tenth anniversary of the Loma Prieta Earthquake.

It has been more than two decades since the last

major urban earthquake in California, and there will be changes after the next inevitable earthquake. For an example of how an earthquake changed an earthquake-prone region, we turn to New Zealand.

## New Zealand

New Zealand, like the Pacific Northwest, is a land of great natural beauty in which the spectacular mountains and volcanoes are related to natural hazards, especially earthquakes and volcanic eruptions. Written records have been kept for less than two hundred years, but during this period, New Zealand suffered damaging earthquakes in 1848, 1855, 1888, 1929, and 1931. The country was thinly populated during most of the historical period, and losses, although locally severe, did not threaten the economy of the nation.

In June and August 1942, the capital city of Wellington and the nearby Wairarapa Valley were struck by earthquakes, the largest of magnitude 7.2, that severely damaged thousands of homes. It was the darkest period of World War II, with the war being waged in Pacific islands not far away to the north. Because of the war, there was little money for reconstruction after the earthquakes, and two years later, much of the rubble in the Wairarapa Valley had not even been cleared. Something had to be done.

In 1944, while the war still raged to the north,

Parliament passed the Earthquake and War Damage Act, and in January 1945, the government began collecting a surcharge from all holders of fire insurance policies. The Earthquake and War Damage Commission was established to collect the premiums and accumulate a fund to pay out damage claims from war or earthquakes. Later, coverage against tsunamis, volcanic eruptions, and landslides was added.

In 1988, Parliament changed the commission from a government department with a state insurance commissioner to a corporation responsible both for its own fund, and for paying a fee for a government guarantee to cover its losses in case a great natural disaster exhausted the fund. In 1993, Parliament changed the name of the administering agency to the Earthquake Commission. Under the new law, the insurance automatically covers all residential properties that are insured against fire. It provides full replacement of a dwelling up to a value of \$100,000 (in New Zealand dollars, including goods and services tax) and contents up to \$22,500. Since 1996, only residential property has been covered, and every property is rated the same, regardless of ground conditions or proximity to an active fault.

The arrangement worked well after 1944, in large part because New Zealand did not suffer a disastrous earthquake in an urban area after the commission was established. Earthquake premiums continued to accumulate at a rate of about \$150 million per year in those years when there are few claims, and as of

December 1998 the fund had \$3.3 billion to cover earthquake losses. The damages paid out as a result of the 1987 Edgecumbe Earthquake (M 6.6) were nearly \$136 million, as compared to \$2.4 million after the much larger 1968 Inangahua Earthquake (M 7.1) nearly twenty years earlier. (Most of the Edgecumbe damages were to commercial property, no longer covered; residential losses were \$22 million in 1987 dollars.) The sharp increase in losses, even after earthquakes of moderate size in rural areas, was an indication that the past would not be the key to the future, especially after a disastrous urban earthquake.

The system was put to the test in September, 2010, when an earthquake of magnitude 7.1 struck in an unexpected place: west of Christchurch, New Zealand's second largest city, resulting in damages of \$2.75 to \$3.5 billion, but no deaths. A later earthquake was of magnitude 6.3 and caused 185 deaths and massive destruction within the city of Christchurch with losses of more than \$30 billion, equivalent to 15% of New Zealand's gross national product. Payout for these losses came from several sources: (1) a reinsurance policy of \$2.5 billion issued by international insurers, (2) the earthquake fund that had been accumulating for decades through the Earthquake Commission, (3) separate private insurance, especially for commercial buildings, and (4) direct government assistance. As a result, the cost of the Christchurch earthquakes, the most costly natural disaster in New Zealand's history, was manageable, and claims are being paid through the

present system. Because of reinsurance, money actually flowed into the country after the earthquake to pay claims.

Even with the insurance, the New Zealand government will pay about \$15 billion of the cost of recovery from the Christchurch earthquakes, and the earthquake fund managed by the Earthquake Commission is now accumulating reserves against the next earthquake, with the hope that the earthquake does not strike before the fund is healthy again. This is in the face of other earthquake threats from a subduction zone and from a strike-slip fault that extends through the capital city of Wellington. One of the factors favoring New Zealand's recovery is that, in contrast to California, around 80% of New Zealanders are insured against earthquakes. Because of its financial commitment to earthquake recovery, the Earthquake Commission supports earthquake research.

## 5. The Nisqually Earthquake

At \$2 billion, the Nisqually Earthquake was the most costly natural disaster in the history of Washington State. Insured losses were \$305 million, about 15 percent of the total. Losses included not only damage to structures but damage to contents and loss of data. Twenty-one percent of businesses had earthquake insurance, but most of their direct losses were less than

their deductible, typically 10 percent of the value of the building and contents. For those businesses with losses greater than \$10,000, about half received earthquake insurance payments. Most small businesses repaired their damage without insurance payments.

Less than one-third of Washington homeowners have earthquake insurance. Safeco, the second largest issuer of homeowners' insurance, includes earthquake insurance on only 8.5 percent of its policies, although this figure is 13.5 percent in King County. The average Safeco earthquake insurance policy cost \$390 per year before the earthquake.

Immediately after the earthquake, insurance companies placed a moratorium of thirty days on writing new policies. The principal reason was to guard against people who had suffered damage in the earthquake obtaining an earthquake policy after the fact.

In summary, and in contrast to the Loma Prieta and Northridge earthquakes in California, the insurance industry came through the Nisqually Earthquake in good financial shape, even though the urban area affected was about the same. The reasons for this were (1) Nisqually was a deep earthquake, and shaking intensities were lower, and (2) the risk exposure was less than it would have been in urban California; fewer people had earthquake insurance.

## 6. What to Do if You Have an Earthquake Claim

United Policyholders, founded in 1991, is a 501(c)(3) nonprofit insurance consumer education organization with headquarters in San Francisco. It publishes a newsletter, *What's UP*, from which much of the information for this section was obtained. For further information, go to

[www.unitedpolicyholders.com](http://www.unitedpolicyholders.com)

The most important thing you can do is before the earthquake: make an inventory. List everything you own, room by room, showing the number of items, their description, age, and cost of replacement. Take photos. Keep all bills and receipts. Keep your inventory and supporting documents someplace other than your house, such as a safe deposit box. Jack Watts of State Farm Insurance Co. told me that “It is difficult to overstate the value of an inventory, photos and receipts. The adjuster is there to work with the claimant in establishing the claim, but it is so much easier when these documents have been kept updated and stored in a separate location from the residence.”

After the earthquake, tell your agent that you have damage and are submitting a claim. Do this even if you are not sure you have an earthquake policy; some losses might still be covered. Review the fine print in your policy, especially the “Declarations” page with categories of coverage and dollar limits. Categories

include dwelling, contents, loss of use (or additional living expenses), other structures, etc. Annual inflation factors increase your limits. You might need advice from an independent professional. If your policy and declarations page were destroyed in the earthquake, contact your insurance agent in writing for a duplicate copy.

Don't give a sworn statement, and don't sign over a final "Proof of Loss" form to your insurer until you are convinced that you understand your coverage, your rights, and the full extent of your claim. Don't be rushed into a quick settlement. Documenting a major loss requires comparing cost estimates from at least two or three reputable contractors, including the one you intend to hire for the actual repairs. Contractors might suggest various repair methods, and if your home or foundation is seriously damaged, you should consult a structural engineer. Keep a diary and record the name and phone number of each person you talk to. It is better, of course, to have photos or receipts to claim destroyed property, but it's recognized that these might have been destroyed during the earthquake. After the earthquake, take photos and keep all receipts.

In rebuilding your home, you're entitled to "like kind and quality." If you have "guaranteed" or "extended" replacement-cost coverage, you're entitled to the same style and quality home even if the replacement exceeds the amount of your policy.

For compensation of additional living expenses or loss of use, keep all receipts for meals, lodging, and



purchases from the time of the earthquake until your house is rebuilt. For additional information, contact United Policyholders at [info@unitedpolicyholders.org](mailto:info@unitedpolicyholders.org)

Even if your damage was from an earthquake, your coverage might be from other policies. For example, a fire in your home might be covered by fire insurance. Tsunami damage might be covered by flood insurance. On the other hand, landslides are commonly not covered by any type of insurance, whether earthquake-related or not.

## 7. Summary Statement and Questions for the Future

Earthquake insurance is a high-stakes game involving insurance companies, policyholders, and in some cases, governments. Because earthquakes are so rare at a given location (in a human time frame, at least), consumers tend to underestimate the need for catastrophic coverage. A Tacoma homeowner was quoted in *Business Insurance* as saying: “My additional premium for earthquake insurance is \$768 per year. My earthquake deductible is \$43,750. The more I look at this, the more it seems that my chances of having a covered loss are about zero. I’m paying \$768 for this?”

The demand for earthquake insurance shoots up after a catastrophic earthquake at the same time the

willingness and capacity of insurance companies to offer such insurance sharply decreases. Insurance is, after all, a business, and for the business to succeed, it must make money.

Insurance companies might underestimate the premiums they should charge in a region like the Pacific Northwest, where a catastrophic earthquake (a subduction-zone or Seattle Fault earthquake rather than a Nisqually Earthquake) has not occurred in nearly two hundred years of recordkeeping. But premiums might be priced too high to attract customers in places that have recently suffered major losses, such as the San Fernando Valley or the San Francisco Bay Area. Indeed, the entire state of California might be in this fix. The CEA offers a policy with reduced coverage and higher premiums, which causes many people to drop their earthquake insurance altogether. Yet many underwriters in the insurance industry are still not convinced that the reduced policy is cost based.

The quality of construction, particularly measures taken against earthquake shaking, will have an increasing impact on premium costs. The Institute of Building and Home Safety (IBHS), an association of insurance companies, has an Earthquake Peril Committee whose goal is the reduction of potential losses. This includes discouraging developers from building in areas at risk from earthquakes and other natural disasters. If a project is awarded an IBHS Seal of Approval, it might be eligible for hazard reduction benefits, including lower premiums.

Recently, the legislatures of Oregon and Washington have funded resilience studies to estimate what it would take to reduce the huge risk faced from a subduction-zone earthquake. Much of the analysis concerns hospitals, businesses, command centers, and lifelines, including water lines, fiber-optic cables, and bridges. Among the concerns: what happens if a business on the coast cannot return to profitability because it is unable to get its products to market, in which case the business might relocate to a safer area less at risk from earthquakes. The resilience survey for Oregon examined all major bridges and concluded that many of these bridges are obsolete and would be likely to fail in a subduction-zone earthquake. Despite this evidence, the 2015 legislature failed to pass a transportation bill that would have begun to address this problem.

California has already done similar studies, including its part of the Cascadia Subduction Zone. These results have been presented to the respective legislatures, but state governments have yet to commit sufficient resources to significantly reduce the risk. Were they to do so, the risk exposure to insurance companies would change dramatically. For summaries, see CREW (2013) and summaries for Oregon and Washington in the References.

The federal government still has not determined what its role should be, and the government responses to Hurricanes Katrina and Sandy are not encouraging. What should the general taxpayer be required to

contribute? Should FEMA's efforts include not simply relief but recovery? Aid in reconstruction rather than low-interest loans? Should earthquake insurance be mandatory for properties in which the mortgage is federally guaranteed? Should it be subsidized by the government, particularly for low-income families who are most likely to live in seismically dangerous housing but cannot afford the premiums if they are truly cost based? The unattractiveness of the CEA mini-policy is causing many Californians to drop all earthquake coverage, which raises a new problem for the finance industry. Thousands of uninsured homeowners might simply walk away from their mortgages and declare bankruptcy if their uninsured homes are destroyed by an earthquake.

Problems such as these tend to be ignored by the public and by government except in the time immediately following an earthquake. There is a narrow time window (teachable moment) for the adoption of mitigation measures and the consideration of ways to deal with catastrophic losses, including earthquake insurance. Authorized by their legislatures, both Oregon and Washington have designed resilience plans, but the price of resilience is steep, and thus far the governing bodies have not come up with the money to become resilient. The taxpayer appears to be willing to go along with this lack of action.

The question about earthquake damage is: who pays? This question has not been answered.

---

## *Suggestions for Further Reading*

California Department of Conservation. 1990. Seismic Hazard Information Needs of the Insurance Industry, Local Government, and Property Owners of California. California Department of Conservation Special Publication 108.

Cascadia Region Earthquake Workgroup (CREW), 2013: Cascadia Subduction Zone Earthquakes: a magnitude 9.0 earthquake scenario, update 2013, 23 p.

Insurance Service Office, Inc. 1996. Homeowners insurance: Threats from without, weakness within. ISO Insurance Issues Series, 62 p.

Kunreuther, H., and R. J. Roth, Sr. 1998. Paying the Price: The Status and Role of Insurance against Natural Disasters in the United States. Washington, D.C.: Joseph Henry Press.

Oregon Seismic Safety Policy Advisory Commission (OSSPAC), 2013, The Oregon Resilience Plan: Reducing Risk and Improving Recovery for the Next Cascadia Earthquake and Tsunami: <http://www.oregon.gov/OMD/OEM/Pages/index.aspx>, summary 8 p.

Palm, R., and J. Carroll. 1998. Illusions of Safety: Cultural and Earthquake Hazard Response in California and Japan. Boulder, CO, Westview Press.

Roth, R. J., Jr. 1997. Earthquake basics: Insurance: What

are the principles of insuring natural disasters?  
Earthquake Engineering Research Institute  
publication.

Washington State Seismic Safety Committee,  
Emergency Management Council, 2012, Resilient  
Washington State, a framework for minimizing loss  
and improving statewide recovery after an  
earthquake: Final report and recommendations:  
Division of Geology and earth Resources, Information  
Circular 114, 38 p.

# II. Is Your Home Ready for an Earthquake?

*“... severe and appalling as this great convulsion of the earth unquestionably was, it is a settled conviction with all here that not a person would have been killed or hurt had their houses all been made of wood.”*

Editorial, *Inyo Independent*, 1872  
after the Owens Valley, California, Earthquake

## I. Introduction: How Safe is Safe Enough?

Chances are two out of three that you'll be at home when the next big earthquake strikes, and one out of three that you'll be in bed. So, your home's ability to withstand an earthquake affects not only your pocketbook but also your life and the lives of those who live with you. If you are an owner or even a renter, you can take steps to make your home safer against an earthquake.

But first you need to make some decisions. Sure, you want to be safe, but how much are you willing to spend

to protect your home and family against an earthquake that may not strike while you are living there? Is it your goal that you and those around you walk away from your house without serious injury, or that your house survives the earthquake as well? Deciding would be easier if scientists could tell you when the next earthquake will strike. But they can't. You might spend a lot of money protecting against an earthquake that might not strike during your lifetime.

This chapter reviews the steps you can take to protect your home, your valuables, and yourself from earthquake shaking, presented in order of importance. The chapter does not consider damage to your house from liquefaction, landslides, surface rupture, subsidence, or tsunamis. It assumes that the ground on which your house is built will be shaken but not permanently deformed by the earthquake.

It is critical to keep your house from collapsing or from catching on fire, so those preventive steps are presented first. This is followed by discussion of other, less critical prevention measures. Then you can make the decision about how much protection is enough for you.



## 2. Some Fundamentals: Inertia, Loads, and Ductility

Imagine for a moment that your house is anchored to a flatcar on a moving train. Suddenly the train collides with another train, and the flatcar stops abruptly. What happens to your house? If it's a wood-frame house, as most houses in the Northwest are, it probably would not collapse, although your brick chimney might topple over. If your house is made of brick or concrete block, unreinforced by steel rebar, then the entire house might collapse.

This analogy introduces an important concept. The jolt to your house during the train wreck is analogous to the shocks the house would receive during a large earthquake, except that the earthquake jolts would be more complicated and would last longer. The motion might be sharply back and forth for tens of seconds, combined with ups and downs and sideways motions. The response of the house and its contents (including you) to these jolts follows the *principle of inertia*.

The principle of inertia says that a stationary object will remain stationary, or an object traveling at a certain speed in a certain direction will continue traveling at that speed and in that direction, unless acted on by some outside force. Because of inertia, your body is pulled to the right when you turn your car sharply left. Inertia is the reason seat belts are necessary. If your car hits a tree and you're not wearing a seat belt, your

body's inertia keeps you moving forward at the same rate as the car before it hit the tree, propelling you through the windshield.

Stack some blocks on a towel on a table. Then suddenly pull the towel out from under the blocks and toward you. The blocks will fall away from you, as if they were being propelled by an opposing force. This force is called an inertial force. The inertia of the blocks tends to make them stay where they are, which means that they must fall away from you when you pull the towel toward you.

I saw a graphic illustration of inertia at the Los Angeles County Olive View Medical Center, which was destroyed by the Sylmar Earthquake in February 1971. Upper stories of the hospital seemed to weather the earthquake without damage. (In fact, glasses of water on bedside tables on the top floor weren't even spilled.) But the walls on the ground floor—which had much more open space and, therefore, was much weaker than the upper floors—were tilted in one direction. The ground beneath the hospital had moved suddenly in a horizontal direction, but the inertia of the hospital building caused it to appear to move in the opposite direction (Figure 12-10). The inertial forces were absorbed in the weaker ground floor. (For an illustration of inertial forces affecting a garage, see Figure 11-6.)

Engineers refer to the forces acting on a building as *loads*. The weight of the building itself is called a *dead load*. Other forces, such as the weight of the contents

of the building—including people, snow on the roof, a wind roaring down the Columbia River gorge, or earthquakes—are called *live loads*. The building must be designed to support its own weight, and this is standard practice. It also must be designed to support the weight of its contents, and this is also standard practice—although occasionally the news media report the collapse of a gymnasium roof due to a load of snow and ice.

Except for high winds and earthquakes, all the loads mentioned above are vertical loads, commonly accounted for in engineering design. But the wind load is a horizontal load. In designing buildings in a location subject to gale-force winds, horizontal wind loads are indeed taken into account. Earthquake loads are both vertical and horizontal. Massive structures attract more seismic forces; wooden buildings are lighter and respond better to earthquake forces. These forces are very complex, and in contrast to wind loads (except for tornadoes) they are applied suddenly, with high acceleration.

I have already discussed acceleration as a percentage of the attraction of the Earth due to its gravity, or  $g$ . During a space shuttle launch, astronauts are subjected to accelerations of several  $g$  as they rocket into space. A downhill ride on a roller coaster temporarily counteracts the Earth's gravity to produce zero  $g$ , and this accounts for the thrill (and sometimes queasy feeling) we experience. Acceleration during an earthquake is the Earth's answer to a roller-coaster

ride. If the shaking is enough to throw objects into the air, the acceleration is said to be greater than one g. High accelerations, particularly high horizontal accelerations, can cause a lot of damage.

The dead weight of a building and its contents can be calculated fairly accurately and can be accounted for in engineering design. These loads are called *static loads*; they do not change with time. Wind loads and earthquake loads change suddenly and unpredictably; these are called *dynamic loads*. The engineer must design a structure to withstand dynamic loads that may be highly variable over a very short period of time, a much more difficult task than designing for static loads alone. Because the awareness of the potential for earthquake loads is only a few decades old, many older buildings were not designed to stand up against the dynamic loads caused by earthquakes.

In Chapter 2, rocks of the crust were described as either brittle or ductile. Brittle crust fractures under the accumulated strain of the motion of tectonic plates and produces earthquakes. The underlying warm and pliable ductile crust deforms without earthquakes.

Structural engineers use these terms to refer to buildings. A building that is *ductile* is able to bend and sway during an earthquake without collapsing. In some cases, the building “bounces back” like a tree swaying in the wind, and it isn’t permanently deformed. Deformation is *elastic*, as described earlier for balloons and boards. In other cases, the building deforms permanently but it still doesn’t collapse, so that people

inside can escape, although in the Northridge Earthquake, it turned out that the welds connecting steel frames were not ductile, and these welds failed. Wood-frame houses are also ductile. Fortunately, most of us live in wood-frame houses.

In contrast, a *brittle* structure is unable to deform during an earthquake without collapsing. Brittle buildings include those made of brick or concrete block joined together with mortar but not reinforced with steel rebar. In an earthquake, your wood-frame house might survive, but your chimney, made of brick not reinforced with rebar, might collapse. Your house is ductile, but your chimney is not (Fig. 11-13).

The reinforcing techniques described below are for a house that has already been built; this is called a *retrofit*. These techniques are also applicable to new construction, in which case they are a lot less expensive. This is immediately apparent in shoring up the foundation. It's the difference between working comfortably on a foundation before the house is built on top of it and working in a confined crawl space.

### 3. Protecting Your Foundation

If you have a poured-concrete foundation, hit it with a hammer to check on its quality. If the hammer makes a dull thud rather than a sharp ping, or there are

throughgoing cracks more than one-eighth inch wide, or the concrete is crumbly, get professional help.

Let's assume that the concrete is okay. The next job is to see if your house is bolted to the foundation and is adequately braced. Otherwise, horizontal inertial forces could slide the foundation out from under the house, which happened to wood-frame houses in northern California during earthquakes in October 1989 and April 1992 (Figure 11-4).

Some houses are built on a concrete slab, or floor. Others have a concrete foundation around the edge of the house. In these, a board called a *mudsill* is generally found between the house and its foundation. Older houses were not required to be bolted to the foundation through the mudsill. In 1973, the Uniform Building Code began to require that walls be anchored to foundations (Figures 11-1, 11-2, 11-3).

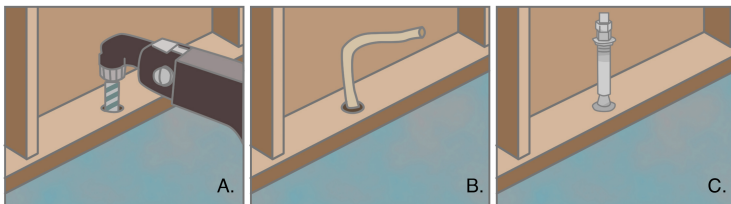

Figure 11-1. Bolt cripple wall (pony wall) to foundation through mudsill, using a sill bolt. (A) Drill hole, using a right-angle drill. (B) Blow powder out of hole, using flexible tubing. (C) Hammer in sill bolt. Tighten nut to expand bolt. From USGS

The standard retrofit technique is to drill a hole

through the mudsill and into the foundation with a rotary hammer or a right-angle drill, which can be rented, although you should purchase your own drill bit. Next, using a sledge hammer, drive a *sill bolt* (or *anchor bolt*) into the hole you've just drilled, having first cleaned out the hole and made sure that it's deep enough to accommodate the sill bolt. The sill bolt has a washer on top and an expanding metal sleeve at the base that slides up, spreads, and wedges in the concrete. Bolt sizes range from one-half by seven inches to three-quarters by ten inches; a standard size is five-eighths by eight-and-one-half inches. The larger ones give more protection against lateral loads and are preferred if the house has more than one story. If the nut on top of the bolt won't tighten, or the bolt climbs out of the hole as you tighten it, the concrete might be decomposing. If so, you could set the bolt with epoxy cement, if allowed by local building codes.

In new construction, the sill bolt is set when the foundation is poured, a fairly simple operation.

The spacing of bolts, in both new construction and in retrofits, is at least one every six feet, and one within twelve inches of the end of any mudsill (Figure 11-3). Placing the bolts midway between the studs (the vertical members that support the walls) makes it easier to work on them.

The next step is stiffening the *cripple wall*

(*pony wall*), which is made of short studs and sits between the mudsill and the floor joists of the house itself (Figures 11-2, 11-3). The cripple wall bounds the crawl space under the house where you're working. The problem here is that if these vertical studs are not braced, they can tilt over like a set of dominoes due to horizontal inertial forces, so that your house collapses on its crawl space and flops down on its foundation (Fig. 11-4).

Since 1973, the Uniform Building Code has required bracing of cripple walls; the bracing requirements were increased in 1991. If your home was built before those critical dates, you might need to brace the cripple wall yourself. The recommended stiffening technique is to use one-half-inch plywood; five-eighths-inch if you use a nail gun (Figures 11-2, 11-3). Treat the plywood with a

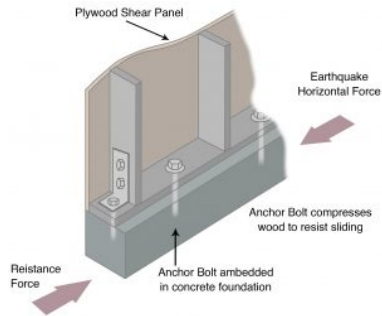
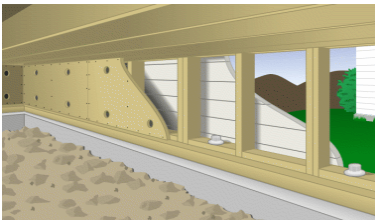

Figure 11-2. Anchor cripple wall to foundation using sill bolts, and to mudsill by hold-down. Cripple wall is further strengthened by plywood shear panel. From Earthquake Engineering Research Institute



preservative prior to installation to prevent rot. Ideally, you should sheathe the entire cripple wall in plywood, but at a minimum, install eight linear feet of plywood from each interior corner of the crawl space for one-story houses; sixteen feet for two-story houses. Anchor the plywood panels with eight-penny nails four inches apart around the edges of each panel and six inches apart on each interior stud. (The nailing pattern is important; one of the most memorable sounds of a house breaking up during an earthquake is the wrenching noise of nails being pulled from the walls.) Drill vent holes one inch in diameter to prevent moisture buildup.



*Figure 11-3. Cripple wall between the foundation and house. Wall is bolted to foundation. Plywood contains air holes to disperse moisture.*

Plywood sheathing should be at least twice as long as it is tall (Figure 11-3). If it isn't, the sheathing should be reinforced with anchors and hold-downs (Figure 11-2). These anchors bolt into the foundation and into corner posts of the cripple walls, increasing the bracing. Another solution, particularly if the cripple wall is very short or if the floor joists of the house rest directly on the foundation, is quarter-inch structural steel bolted with expansion bolts into the foundation and into the floor joists.

A do-it-yourselfer will spend at least \$600 for the materials. However, working in crawl spaces is messy

and confined, and you might wish to employ a professional. This will cost you several times as much as doing the job yourself; a contractor might charge as much as twenty-five dollars per installed bolt. But *reinforcing the cripple wall and bolting to the foundation are the most important steps you can take to save your house.* Cripple-wall failures are shown in Figures 11-4 and 11-5.



*Figure 11-4. This Victorian wood-frame house in Ferndale, California, was built on a post-and-pier foundation, but was not bolted to its foundation, so that it slid off during the 1992 Cape Mendocino Earthquake. The floor level of the house was at the same height as the front steps. The house moved to the right and down with respect to the steps. The wooden skirting, formerly part of the outside wall, is now flat on the ground. Left-hand photo is view of house from front, and right-hand photo is view from one side. Photos courtesy of National Oceanic and Atmospheric Administration*



*Figure 11-5. This house south of Petrolia, California, shifted off its foundation during the 1992 Petrolia Earthquake because it was not anchored to the foundation, and its cripple wall was not reinforced. The house shifted to the right, as seen by the collapsed wooden skirting. The separation of the house and the small porch is an example of connection failure. Photo courtesy of National Oceanic and Atmospheric Administration*

As insurance companies in the Pacific Northwest begin to base earthquake-insurance premiums to the details of construction of your house, as they now do in California, reinforcement will almost certainly reduce your premium. You are likely to be denied earthquake insurance if your house is not bolted to its foundation.

## 4. Soft-story Buildings

A common failure in California's recent earthquakes was the two- or three-car garage with living space overhead. Many condominiums have most of the ground floor devoted to parking, with apartments in the upper floors. The large open space at the garage door means less bracing against horizontal forces than in standard walls, so these open areas are the first to fail in an earthquake (Figure 11-6). A wood-frame apartment building is lighter and fares better than a massive concrete structure like a hospital. Similar problems arise on a smaller scale with large picture windows, sliding-glass patio doors, or double doors.



*Figure 11-6. Soft-story failure to three-car garage during 1971 Sylmar, California, Earthquake. The large door opening resulted in inadequate shear resistance to horizontal ground motion. Photo by J. Dewey, USGS*

Make sure that the wall around the garage door and the wall in the back of the garage, on the opposite side from the door, are sheathed with half-inch plywood, just as cripple walls are. Because of the limitations for bracing on the garage door itself, bracing the back wall, opposite from the door, will increase the overall resistance of the structure to earthquake ground motion sideways to the door.

Plywood sheathing should completely surround any large picture window or set of double doors. The sheathing should be at least as wide as the opening and extend from bottom to top of the opening. The interior wall is finished in drywall or plaster, so the best time to add sheathing is during initial construction or major remodeling.

## 5. Utility Lines

One of the greatest dangers in an earthquake is fire. Fire caused much of the loss of life and property in the 1906 San Francisco Earthquake and the 1995 Kobe Earthquake, and large fires destroyed property in the Marina District of San Francisco after the 1989 Loma Prieta Earthquake. The problem is natural gas.

If gas connections are rigid, they are likely to shear during an earthquake, releasing gas that needs only a spark to start a fire. Gas connections should be *flexible*. After an earthquake, you must shut off the main gas

supply to the house (Figure 11-7). Learn where the gas supply line is and ensure that the shut-off valve is not stuck in place by turning it one-eighth turn (one-quarter turn is the closed position). Your gas company will sell (or give) you an inexpensive wrench (illustrated in Figure 11-7) that should be kept permanently *near the valve*. Tell all members of the family where the wrench is and how to use it. In the event of a major earthquake, shutting off the gas is a top priority. You won't have time to rummage around a heavily damaged house looking for a wrench.

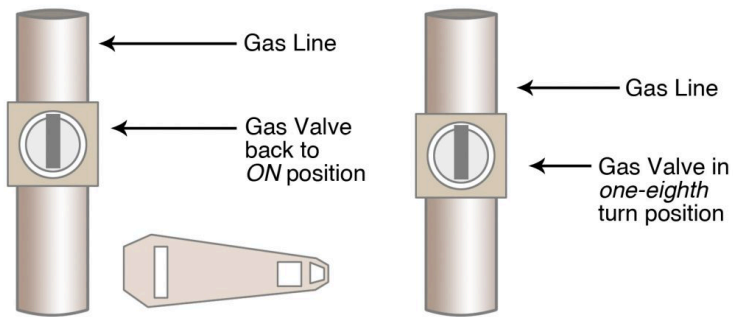

Figure 11-7. Shut-off valve for the main gas supply line to house. Left: valve in "on" position. Right: Check to be sure valve is not frozen by turning it one-eighth turn. Specialized wrench available from gas company is also shown.

For \$400 to \$600, you can have an automatic shutoff valve installed on the gas line. This valve, located between the gas meter and the house, is activated by earthquake shaking, which knocks a ball or cylinder off

a perch inside the valve into a seat, thereby shutting off the gas. Consider an automatic shutoff valve if you are away from home a lot and are not likely to be around to shut off your gas after an earthquake. A disadvantage of the automatic shutoff valve is that you wouldn't be able to tell easily if you had a gas leak in your house after the valve had shut off the gas. If you're confident that you don't have a gas leak, you should know how to reset the valve yourself, because after a major earthquake, weeks might go by before the gas company or a plumber could get to your house and reset the valve for you. Remember that when the valve is reset, you must immediately relight all the pilot lights in your appliances.

All gas lines and water pipes should be supported at least every four feet. Earthquake vibrations can be strongly exaggerated in unsupported pipe in your basement or crawl space. If pipes are not supported, strap them to floor joists or to walls.

If liquefaction occurs, underground utility lines might be severed, even if your house is anchored below the liquefying layer and doesn't fail. Underground gas lines failed due to liquefaction in the Marina District of San Francisco, triggering many fires.

A generator can supply emergency power, but this should be installed by a licensed contractor. The generator should be installed in a well-ventilated place outside the home or garage, and fuel should be stored according to fire regulations. A generator installed in

a closed place in the house could lead to carbon monoxide poisoning.



## 6. Strapping the Water Heater and Other Heavy Appliances and Furniture

Your water heater is the most unstable appliance in the house. It's heavy, being full of hot water, and it's tall, likely to topple over due to horizontal forces from an earthquake.

Strap the water heater in place, top and bottom, with heavy-gauge metal straps (not plumber's tape, which is too brittle to be effective). Anchor the straps to studs in the wall at both ends (Figure 11-8). Make a complete loop around the water heater (one and a half times) before anchoring it to the studs. This precaution is very easy and inexpensive to do

and will not reduce the effectiveness of the water heater at all. Commercial kits are available from Walmart, Lowe's, Home Depot; contact Seattle's SDART

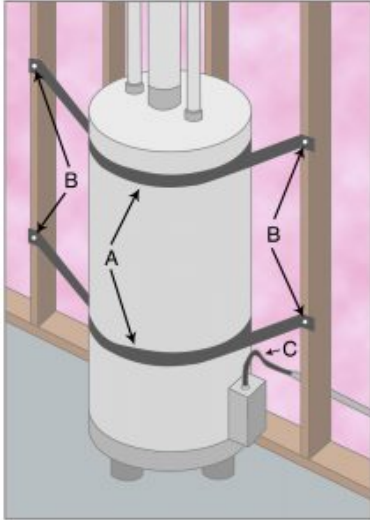

Figure 11-8. Strap water heater, top and bottom, with metal straps (A) which completely encircle the heater and are attached to studs (B). If the water is heated by gas, the gas supply line (C) should be flexible. In this example, water heater rests against stud. If water heater is against drywall or plaster wall, brace it with a two-by-four so that it does not bang against the wall.

Program for further information. One company is Hubbard Enterprises at [www.holdrite.com](http://www.holdrite.com), phone 800-321-0316.

If the water heater is right against the wall, brace it against the wall with two-by-fours so that it doesn't bang against the wall during an earthquake. If it's against a concrete wall, install quarter-inch expansion bolts directly into the concrete on both sides of the water heater and run steel cable through the eye screws, again making a complete loop around the heater.

If you have a water cooler, with a large heavy water bottle on top, strap this, too. You will need the water if your water supply is shut off during an earthquake.

Built-in dishwashers, stoves, and ovens might not be braced in place; they may only rest on a trim strip. One homeowner was quoted in *Sunset Magazine* after the October 1989 Loma Prieta Earthquake: "I assumed built-in appliances are fixed in place. NOT SO! Our built-in oven and overhead built-in microwave slid out." Make sure your appliances are securely braced (Figure 11-9). A gas stove might topple over, snapping the gas line and causing a fire. Secure the refrigerator to the wall. Babyproof refrigerator door locks are effective in preventing food in the refrigerator from spilling out on the floor.



*Figure 11-9. Damage to contents of the kitchen in a residence in Petrolia, California, as a result of the 1992 Cape Mendocino Earthquake. Appliances shifted several inches away from the wall. All items were shaken off the shelves with considerable glassware breakage. Photo courtesy of National Oceanic and Atmospheric Administration.*

Look around your house for tall, top-heavy furniture such as a china cabinet, tall chest of drawers, bookcase, or wardrobe. Attach these to studs in the wall to keep them from falling over (Figure 11-10). There are two concerns. One is the loss of heirloom china in your china cabinet. The other is the possibility of a heavy piece of furniture falling on you or on a small child. For either of these reasons alone, securing these large pieces of furniture to the wall is a good idea. Home computers and flat-screen televisions should be secured in the same way.



*Figure 11-10. Bookcases collapsed during 2001 Nisqually Earthquake, showing the necessity of attaching heavy furniture to wall, especially furniture that might land on sleeping children.*

## 7. Safety Glass

A major problem in an earthquake is shattered glass windows, which might flex and essentially blow out, showering those within range with sharp glass fragments. An expensive option is to replace glass in

large picture windows or sliding doors with tempered or laminated glass. A much cheaper alternative is safety film, which costs about three to four dollars per square foot, installed. This bonds the glass to a four-mil thick acrylic sheet; the adhesive strengthens the glass and holds it together if it breaks, like the safety glass in a car windshield. You can do this yourself, but it's difficult to prevent air bubbles from being trapped under the film, so consider having it installed professionally.

## 8. Cabinets

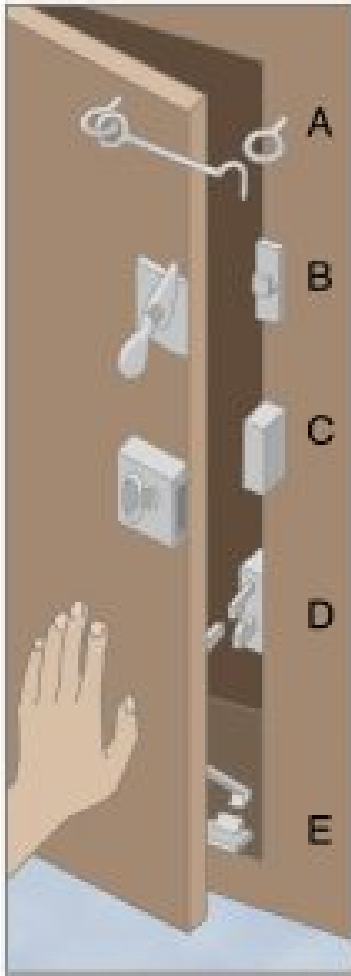

Figure 11-11. Safety latches for earthquakes. The simple hook and eye (A) is inexpensive and secure, but you may not remember to close it each time you use the cabinet because it takes an extra step to do so. Some latches (B, C) mount on

Remember José Nuñez of Molalla, Oregon, who watched his kitchen cabinets blow open during the 1993 Scotts Mills Earthquake, spewing their contents onto the kitchen floor? Magnetic catches often fail. However, inexpensive babyproof catches will keep cabinet doors closed during an earthquake (Figure 11-11). Heavy, spring-loaded latches are advised, especially for cabinets containing valuable dishes.

If small children live in your house, you might already have babyproof catches, but they're probably only on cabinets near the floor, within a child's reach. For earthquake protection, the most important places for babyproof catches are the *highest*

*the surface of the door; others (D) mount inside the door, hold the door firmly shut, and are opened by being pushed gently inward. A child-proof latch (E) prevents the door from being opened more than an inch or two. They close automatically, but are more trouble to open.*

cabinets, particularly those containing heavy, breakable dishes or fragile glassware. Don't forget the medicine cabinet in the bathroom, where prescription medicine could fall on

the floor and mix, producing a toxic combination.

Put layers of foam or paper between heirloom plates that are seldom used but are at great risk during an earthquake. Line your shelves with nonskid shelf padding, available at marine- and recreational-vehicle supply houses, because they are also useful to keep items on the shelf during a heavy sea or when your recreational vehicle is traveling down a bumpy road. In a similar vein, consider a rail or plastic strip around open shelves to keep items from falling off (Figure 11-12). Hold-fast putties are small balls that flatten and stick to the bottom of a large vase to keep it from toppling over; these putties will peel off and leave no residue. Lead weights in old socks can be placed in the bottom of vases or table lamps to keep them in place.

You won't be able to take all these precautions. But, considering that a third of your life is spent in bed, lie down on your bed and look around for items that could fall on you during an earthquake. A heavy chest of drawers? A bookcase (Figure 11-10)? A large wall mirror? A ceiling fan? A large headboard? Secure those items that might endanger your life. Then do the same for



the beds where other members of your family sleep, particularly small children. (Maybe it's simpler to move the bed than to secure the furniture!)

Renters might be restricted by the landlord from fastening furniture to the wall. A discussion with the landlord might help, particularly if you are willing to patch the holes in the wall when you move.

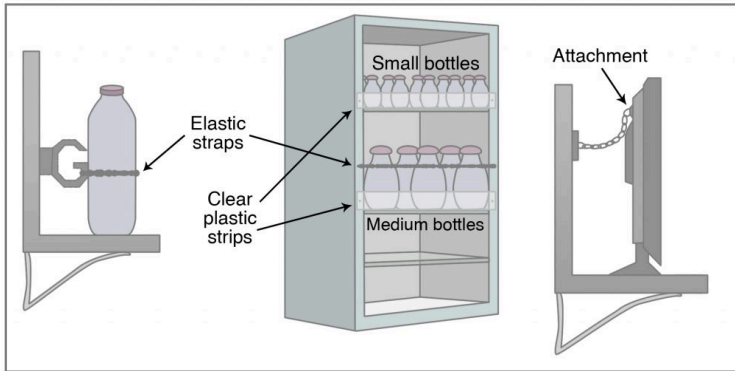

Figure 11-12. Securing items on open shelves: (Left) Attach counter-top items to wall with bungee cord. (Center) Secure small items with a vertical strip and larger items with a strip and bungee cord. (Right) Large items, like a TV set, can be attached to wall with chain.

## 9. Bricks, Stonework, and Other Time Bombs

If you live in an old, unreinforced brick house, you are in real danger, and none of the retrofit techniques

mentioned above will do much good outside of a major costly reinforcing job. Fortunately, old brick houses in the Pacific Northwest are being phased out of the building inventory; most of us live in wood-frame houses.

But one part of your house is still likely to be unreinforced—your masonry chimney (Figure 11-13). Chimneys collapse by the hundreds during major California earthquakes. Many chimneys were damaged during the Nisqually Earthquake, and one collapsing chimney seriously injured Curtis Johnny inside his apartment. Most commonly, chimneys snap at the roof line. A tall chimney is likely to be set in motion by earthquake waves, resulting in collapse. The taller the chimney, the more likely it is to fall through the roof into your house. Some recent building codes require internal and external bracing of chimneys to make them more likely to survive an earthquake.



*Figure 11-13. Brick chimney on this house in Petrolia, California, collapsed during the 1992 Cape Mendocino Earthquake. Photo courtesy of National Oceanic and Atmospheric Administration*

Even if your chimney didn't fall during the earthquake, it might have been damaged, partially or completely blocking the flue. If this happens, gases produced by your furnace, including carbon monoxide, may enter your house, possibly enough to kill you. How do you know you have a problem unless you have a carbon monoxide detector? Your family might become ill in the house. Another clue is water-vapor condensation on your windows, a product of burning natural gas that is not vented properly. Have your chimney checked by a professional, even if it looks okay after the earthquake. Install a detector.

A good rule of thumb is to consider how much of a

threat your chimney poses. If someone could be killed or severely injured by a falling chimney, take it down. Prefabricated metal chimneys can be attached to an existing brick firebox so that no brick projects above the roof line.

Inside the house, there's the mantel. The mantel may be field stone—very attractive, but very heavy if it fails, particularly if the mortar has been weakened by a chimney leak. Field stone and brick veneer on the outside of the house may pose a hazard as well. If you want a natural stone appearance, install the lightest-weight material you can.

Freestanding wood-burning stoves are popular in the Pacific Northwest. A study done by Humboldt State University found that more than half the wood-burning stoves in the area near the epicenter of the April 1992 M 7.1 Cape Mendocino Earthquake moved during the earthquake, and several fell over. Fire codes in some states leave stoves unsupported on all four sides, which might cause them to slide or turn over during an earthquake. If a stove tips over and separates from its stovepipe, cinders or sparks can cause a fire.

The following steps are recommended (Figure 11-14). (1) Anchor a stove resting on a brick hearth, attaching the stove legs to the hearth with bolts. Mobile-home-approved stoves have predrilled holes in the legs for anchoring to the floor framing. (2) Anchor a stove resting on a concrete slab directly to the concrete. (3) Anchor the stovepipe to the flue, and tie together each of the stovepipe segments.

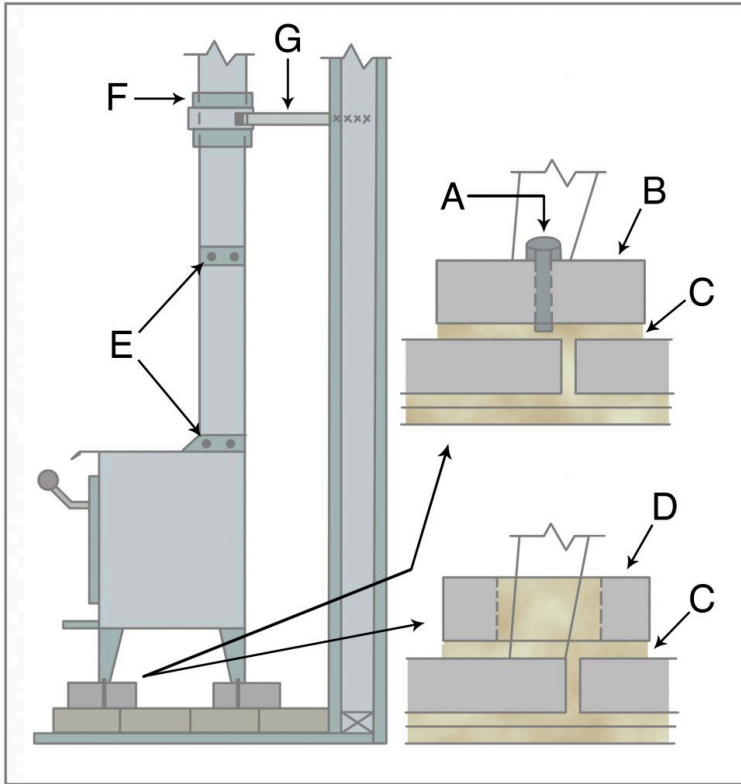
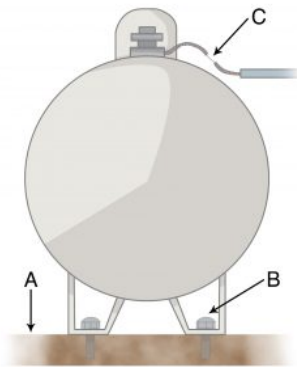

Figure 11-14. Anchor a stove built on a brick hearth with three-eighths-inch diameter bolt (A) through half-inch hole to new brick (B). Grout brick to existing hearth with one inch of new grout (C). As an alternative, build an eight-inch-square brick pad with grout pocket (D) at each leg. There should be at least one inch of grout around each leg; fill pocket completely with grout. Provide sheet metal screws (E) at flue exit and between stovepipe sections. Provide a radiation shield with pipe clamp (F) braced to wall, using tension ties attached to wall stud with three-eighths-inch by three-inch lag screws. From Humboldt Earthquake Education Center, Humboldt State University

In the Kobe Earthquake, thousands of people were killed in their beds in wood-frame houses because their roofs were of tile, which made the houses top-heavy and more subject to collapse. Clay tile roofs are the heaviest; composition or wood roofs are lighter. If you reroof your house, add plywood shear panels over the rafters. This is often required in new construction and might be required if you remodel. It strengthens the house.

## 10. Propane Tanks

Above-ground propane tanks can slide, bounce, or topple during an earthquake, causing a fire hazard from a gas leak. You can reduce the fire danger by doing the following (Figure 11-15): (1) Mount the tank on a concrete pad and bolt the four legs of the tank to the pad. (2) Install flexible hose connections



*Figure 11-15. Propane tank. Mount tank on six-inch-thick concrete pad (A) using four half-inch diameter bolts (B) with three-inch minimum embedded into concrete. Provide a flexible hose connection (C) between tank and the rigid supply line. From Humboldt State University*

between the tank, the supply line, and the entrance to your house. (3) Clear the area around the tank of objects that could fall and rupture the tank or its gas supply

line. (4) Tie a wrench near the shut-off valve, and make sure all family members know where it is and how to use it. For large tanks, such as those used commercially or on a farm, install a seismic shut-off valve.

## **II. Connections**

One of my most instructive memories of the 1971 Sylmar Earthquake was a split-level house, where earthquake shaking accentuated the split between the garage with a bedroom over it and the rest of the house (Figure 11-16). A common sight is a porch that has been torn away (Figure 11-5), or a fallen deck or balcony. These connections are the potential weak link in the chain that is your home. Make sure that everything is well connected to everything else so that your house behaves as a unit during shaking.



*Figure 11-16. Split-level house in Crestview Tract, San Fernando Valley, showing failure of the connection between the single story (right) and the two-car garage with bedrooms above. Note the difference in height between the front steps and the single story, indicating cripple-wall failure of the single story. Photo by Robert Yeats*

## **12. Mobile Homes and Manufactured Houses**

Because these houses must be transported to their destination, they are more likely than an ordinary house to behave as a coherent structural unit during an earthquake. Manufactured houses are built on one or more steel I-beams that provide structural support in the direction of the I-beam. However, mobile homes and manufactured houses are commonly not bolted to



a foundation, but instead rest on concrete blocks that are likely to collapse during even low horizontal accelerations (Figures 11-17, 11-18). This would cause the house to flop down onto its foundation, as illustrated earlier for cripple-wall failures. A mobile home is likely to undergo less structural damage than an ordinary house, but is more likely to suffer extensive damage to the contents of the house. The house could be prevented from sliding off its blocks during an earthquake by replacing the blocks with a cripple wall and securing it as described above for ordinary houses. This would make the house insurable against earthquakes.



*Figure 11-17. This manufactured home slipped off its supporting piers during an earthquake. This type of failure can be avoided by bolting the house to its foundation, as is required for other houses in most states. From Karl Steinbrugge Collection, University of California at Berkeley*



Figure 11-18. Mobile home has slid off its supports during an earthquake. Photo courtesy of California Office of Emergency Services

A double-wide mobile home must be well connected at the join between the two halves (*marriage line*) so that the two halves do not fail at the join and move independently during strong shaking. Ridge beams should be attached with half-inch carriage bolts spaced at a maximum of forty-eight inches at ninety degrees and three-eighths-inch lag screws, with washers, spaced every twenty-four inches at forty-five degrees maximum angle. Floor connections must use three-eighths-inch lag screws with washers installed diagonally at forty-five degrees or less, with spacing not exceeding thirty-two inches. Even so, it's likely that a double-wide manufactured home will fail at the

marriage line if it slips off its concrete block foundation during an earthquake.

### **13. Okay, So What Retrofitting Are You Really Going to Do?**

You probably won't take all of these steps in making your home safer against earthquakes. Doing everything would be costly and might not increase the value of your home, unless it successfully rides out an earthquake. So you might decide to live with some risk.

At least do the following: (1) bolt your house to its foundation, (2) strengthen your cripple wall, (3) install flexible connections on all your gas appliances and make sure the main shut-off valve can be turned off quickly in an emergency, (4) secure your water heater, and (5) make sure that large pieces of furniture or large ceiling fixtures won't collapse on anyone in bed. This protects you against a catastrophic collapse of your house, and against fire or serious injury.

Home retrofit kits are available through the Federal Emergency Management Agency, the City of Seattle, and the California Office of Emergency Services. With the increasing knowledge about earthquake hazards in the Northwest, some builders now offer their expertise in seismic retrofits. Kits to strap the water heater,

fasten cabinets, and anchor heavy furniture are available commercially.

---

### *Suggestions for Further Reading*

California Office of Emergency Services. An Ounce of Prevention: Strengthening Your Wood Frame House for Earthquake Safety. Video and how-to booklet.

Humboldt Earthquake Information Center. How to survive earthquakes and tsunamis on the north coast. Arcata, CA, Humboldt Earthquake Information Center, Humboldt State University, 23 p.

Lafferty and Associates, Inc. 1989. Earthquake preparedness—for office, home, family and community. P.O. Box 1026, La Canada, CA 91012.

Project Impact. 2002. Home earthquake retrofit series, 3 volumes, available from Federal Emergency Management Agency and City of Seattle.

Seismic Safety Commission (California). 1992. The homeowner's guide to earthquake safety. 28p.

Sunset Magazine. 1990. Quake—2-part series in October and November 1990 issues, available as reprints (Sunset Quake '90 Reprints) from Sunset Publishing Company, 80 Willow Road, Menlo Park, CA 94025.

# 12. Earthquake Design of Large Structures

*“I don’t know. This looks like an unreinforced masonry chimney to me.”*

Santa Claus, undated

*“The building acted as it should. It’s really rewarding to know with the pains we took and the money we spent on behalf of the building, that it worked.”*

Angi Davis, property manager of Starbucks Center in Seattle, constructed in 1912, commenting on the retrofit of the building prior to the Nisqually Earthquake

## I. Introduction

It’s impossible to earthquake-proof a building. A look at the intensity scale (Table 3-1) shows that for intensities of IX and worse, even well-designed and well-constructed buildings can fail. However, most earthquakes have maximum intensities of VIII or less, and well-constructed buildings should survive these

intensities. The highest intensity recorded in a Pacific Northwest earthquake was VIII in the 1949 Puget Sound Earthquake and locally on Harbor Island in Seattle in the 2001 Nisqually Earthquake. However, an earthquake on the Seattle Fault or the Cascadia Subduction Zone would have higher intensities.

Building codes should be designed so that a building will resist (1) minor ground motion without damage, (2) moderate earthquake ground-shaking without structural damage but possibly with some nonstructural damage, and (3) major ground motion with an intensity equivalent to the maximum considered earthquake (MCE) for the region (Chapter 7) without structural collapse, although possibly some structural damage. In this last case, the building could be declared a total loss, but it would not collapse and people inside could escape safely.

Upgrading the building code does not have an immediate effect on safety. Building codes affect new construction or major remodeling of large existing buildings; if a building is not remodeled, it will retain the safety standards at the time it was constructed. The greatest losses in recent California and Puget Sound earthquakes were sustained by old, and non-ductile reinforced concrete frames with and without unreinforced masonry walls. For example, forty-seven of the sixty-four people who died in the 1971 Sylmar Earthquake lost their lives due to the collapse of a single facility, the Veterans Administration Hospital (Figure 12-1). This was a reinforced-concrete structure

built in the 1920s, before the establishment of earthquake-related building standards after the 1933 Long Beach Earthquake. The collapsed buildings were designed to carry only vertical loads. Figure 12-1 is an aerial view of the hospital campus immediately following the earthquake. The building in the photograph that held up well had been reinforced after the 1933 earthquake. Clearly, retrofitting paid off in terms of lives saved.



*Figure 12-1. Aerial view of the damage to the San Fernando Veterans Administration Hospital campus after the 1971 Sylmar, California Earthquake. Forty-seven of the sixty-four deaths attributed to the earthquake were a result of the collapse of this structure, built in 1926, before earthquake-resistance building codes were adopted. Adjacent building, constructed after building codes were upgraded after the 1933 Long Beach Earthquake, did not collapse. Photo by E. V. Leyendecker, U.S. Geological Survey*

In the same vein, the greatest losses in Pacific Northwest earthquakes, including the 1949, 1965, and 2001 Puget Sound earthquakes (Figure 12-2) and the 1993 Scotts Mills and Klamath Falls, Oregon, earthquakes (Figure 6-25) were in old unreinforced masonry buildings, especially schools, which seem to take the longest time to replace.



*Figure 12-2. Close-up of an entrance to Lafayette School in West Seattle, covered with bricks that fell from this unreinforced masonry building during the 1949 Puget Sound Earthquake. Fortunately, the school was not occupied at the time, and no children were killed or injured. Damage to this and other schools in the 1949 and 1965 earthquakes led to a major retrofit of school buildings that minimized school damage in the 2001 earthquake. Photo courtesy of Washington Division of Geology and Earth Resources.*



It's much more expensive to retrofit a building for earthquake safety than it is to build in the same safety protection for a new building. Typically, a simple structure will cost at least nine to ten dollars per square foot to retrofit. A nonductile reinforced concrete frame structure will be two to three times more expensive. The cost for a historic building could reach a hundred dollars per square foot. The owner of the building must consider the possibility that the money spent in upgrading might not be returned in an increased value of the building or increased income received from it, unless a change of use for the building is proposed.

It is for these reasons that it takes so long to upgrade the building inventory of a city. Owners of buildings in downtowns in the Pacific Northwest continue to rely on at-risk unreinforced masonry (URM) buildings for their economic livelihood, gambling that the expected great earthquake will not arrive any time soon.

Legislation can speed the process along. In 1986, the State of California passed a law requiring local jurisdictions to identify all potentially hazardous buildings and then adopt policies and procedures reducing or eliminating potentially hazardous conditions. After the 1989 Loma Prieta Earthquake and the 1994 Northridge Earthquake, the URM Law was passed in 1996 in the Bay Area, making it mandatory to retrofit URM buildings. This means that that part of the subduction zone in northern California is safer than the subduction zone farther north. It is only in 2015 that the City of Portland and Seattle are looking

into developing policies for mandatory URM retrofits. If the unreinforced masonry (URM) building has historical value, the owner should consider having the building designated as a historic structure, opening up the availability of funds for retrofitting historic structures.

## 2. Seismic Retrofitting

The Starbucks Center occupies a nine-story building that was formerly a Sears catalog store constructed in 1912 on tidal fill next to Elliott Bay. Before Starbucks moved in, the City of Seattle required an earthquake upgrade costing \$8.5 million. Nearly two thousand people were in the building when the Nisqually Earthquake struck. People dove under desks and tables. Rick Arthur, a Starbucks vice-president, said that “it felt like a typhoon coming through. ... The floor rose in big waves. At first, we felt it was a fairly minor event, but it kept going and building in intensity. The lights were swinging in big arcs.” Some of the walls cracked, and a four-foot brick parapet on top of the building crashed to the ground. But everyone got out safely, and there were no injuries. Arthur said his first thought was, “Thank you, Terry,” referring to Terry Lundeen, a structural engineer with Coughlin Porter Lundeen, who managed the Starbucks retrofit. Money well spent.

Traditionally, the goal of seismic retrofitting, like the goal of building codes, has always been to allow people

inside the structure to survive the earthquake. Damage control and protection of property are secondary, except for certain historic buildings, as discussed above. Recent concepts of performance-based earthquake engineering are placing greater emphasis on controlling property damage to avoid financial losses, including loss of business for a commercial building. Damage control is also important for critical facilities such as hospitals, police stations, and fire stations.

Brittle structures behave poorly during earthquakes.

Unreinforced masonry that bears the structural load of a building with poorly tied floor and roof framing tends to fail by wall collapse. Nonductile concrete-frame buildings are subject to shear failure of weak, unconfined columns. Framed structures with large parts of their walls not tied together tend to behave structurally as soft-story structures (like the three-car garage in the San Fernando Valley shown in Figure 11-6). In recent earthquakes, including the 1994 Northridge Earthquake, these structures have failed catastrophically, with loss of life.

Strengthening of existing buildings must ensure that the added

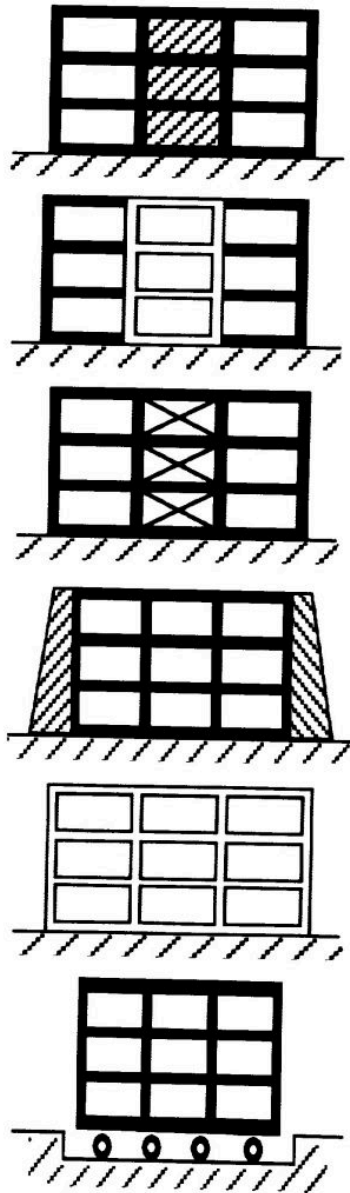

Figure 12-3. Possible retrofit strategies for old buildings. (a)

reinforcing is compatible with the material already there. For example, a diagonal steel brace might be added to a masonry wall. The brace is strong

*Infill walls. (b) Add interior or exterior frames. (c) Completely rebuild. (d) Add braces (e) Completely rebuild. (f) Add buttresses. From AIA/ACSA Council on Architectural Research, Washington, D.C.*

enough, but it would not carry the load during shaking until the masonry had first cracked and distorted. The brace can prevent total collapse, but the building might undergo enough structural damage to be considered a total loss. It is only recently that there are success cases of these retrofitted structures in California following the URM law and its implementation by local government. During the 2014 Mw6.0 South Napa Earthquake in California, many retrofitted and non-retrofitted buildings suffered damage. One year later, in August 2015, an important finding was made: even though retrofitted URM buildings had seen slight to moderate damage, most of these buildings were under repair; in contrast, most of the damaged non-retrofitted buildings were commissioned to be demolished after building owners considered them to be a total loss.

A test of the California URM Law came with the 2014 magnitude 6 South Napa Earthquake, in which both retrofitted and non-retrofitted buildings were damaged. In the following year, it was determined that even though retrofitted URM buildings had undergone slight to moderate damage, most of them were being repaired. In contrast, buildings that had not been

retrofitted at the time of the earthquake were determined by their owners to be a total loss, and they were commissioned to be demolished.

Figure 12-3 shows several types of retrofit solutions for old buildings. The walls may be strengthened by infill walls, by bracing, by post-tensioning, by external buttresses (beautifully displayed by medieval Gothic cathedrals in western Europe), by adding an exterior or interior frame, or by base isolation. The building needs to behave as a unit during shaking, because the earthquake is likely to produce failure along weak joints.

There are several lateral force-resisting systems for withstanding the earthquake-induced forces, including moment resistant frames, shear walls, and braced frames, for example. In addition, the lateral-resisting system may be a combination these systems. These lateral-resisting systems can be constructed out of reinforced concrete, structural steel, reinforced masonry, or even timber. At the floor levels, the lateral resisting forces are transferred through a diaphragm.

The term *diaphragm* is used for a horizontal element of the building, such as a floor or a roof, that transfers horizontal forces between vertical elements such as walls or columns (Figure 12-4a). The diaphragm can be considered as an I-beam, with the diaphragm itself the web of the beam and its edges the flanges of the beam (Figure 12-4b). In most buildings, holes are cut in the diaphragm for elevator shafts or skylights (Figure 12-4c). These holes interrupt the continuity and thereby

reduce the strength and stiffness of the diaphragm (Figure 12-4d).

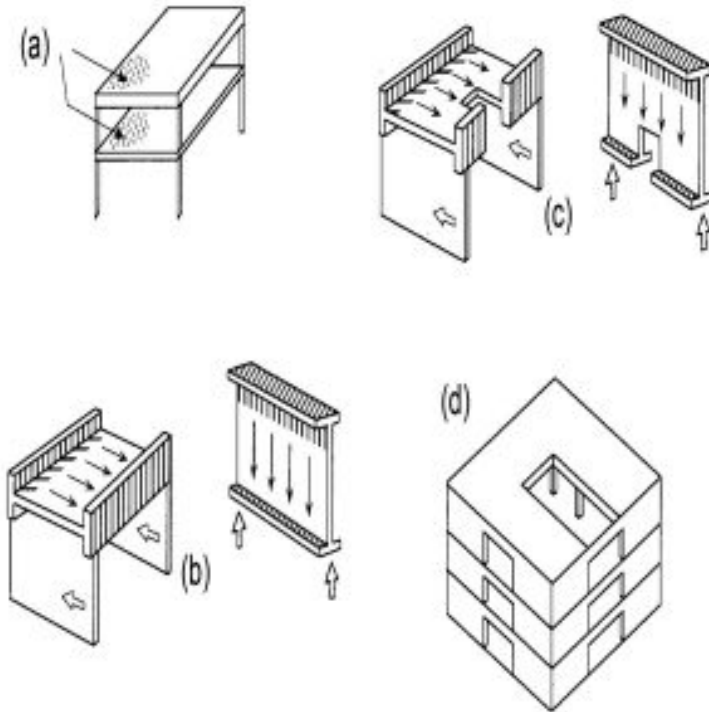

Figure 12-4. (a) A Horizontal diaphragm. Failure typically occurs at connections to vertical columns. (b) Concept of diaphragm as a horizontal I-beam. (c), (d) Holes in beams or diaphragms for elevator shafts, large doors, etc., interrupt continuity and reduce strength. From AIA/ACSA Council on Architectural Research.

Lateral forces from diaphragms are transmitted to and from the ground through *shear walls* or moment

resisting frames. The forces are shear forces, those tending to distort the shape of the wall, or bending forces for slender structures like a skyscraper (Figure 12-5). Construction may include walls that have higher shear strength or diagonal steel bracing, or both.

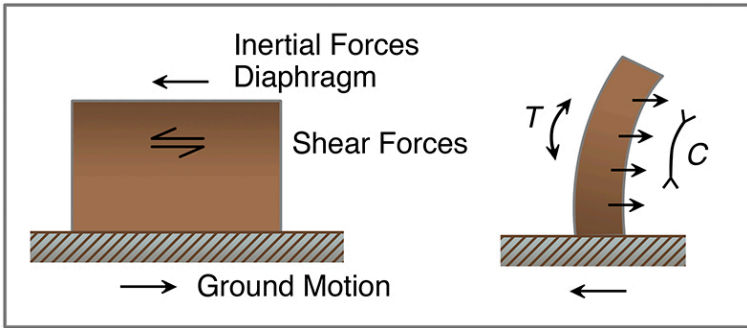

Figure 12-5. Shear walls resist shear stresses transmitted from the ground and bending stresses in slender, tall buildings. C, compression; T, tension. From AIA/ACSA Council on Architectural Research.

*Moment-resistant frames* are more flexible than shear-wall structures; they are less likely to undergo major structural damage but more likely to have damage to interior walls, partitions, and ceilings (Figure 12-6). Several steel-frame buildings failed in the 1994 Northridge Earthquake, but the failures were in large part due to poor welds at the joints—a failure in design, construction, and inspection.



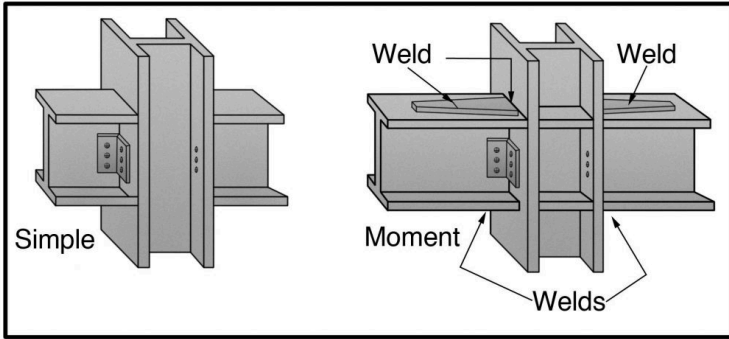

Figure 12-6. Joint used in a moment-resistant frame.

### 3. Base Isolation

The normal approach to providing seismic resistance is to attach the structure firmly to the ground. All ground movements are transferred to the structure, which is designed to survive the inertial forces of the ground motion. This is the reason why your house is bolted to its foundation and your cripple wall is reinforced.



*Figure 12-7. Failure of hanging light fixtures at library of Dawson Elementary School in California, fortunately unoccupied at time of earthquake. Note fallen ceiling tiles and plaster. Photo credit: Earthquake Engineering Research Institute*

In large buildings, these inertial forces can exceed the strength of any structure that has been reinforced within reasonable economic limits. The engineer designs the building to be highly ductile, so that it will deform extensively and absorb these inertial forces without collapsing. Moment-resistant steel-frame structures are good for this purpose, as are special concrete structures with a large amount of steel reinforcing.

These buildings don't collapse, but, as stated above, they have a major disadvantage. In deforming, they can cause extensive damage to ceilings, partitions, and building contents (Figure 12-7) such as filing cabinets and computers. Equipment, including utilities, will stop operating. High-rise buildings will sway and might cause occupants to become motion-sick and panicky. In addition, staircases may fail, hindering evacuation of the building after an earthquake.

The problem with attaching the building firmly to the ground is that the earthquake waves are absorbed by the building and its contents, often destructively. Is there a way to dissipate the energy in the foundation *before* it reaches the main floors of the building?

In *base isolation*, the engineer takes the opposite approach: the objective is to keep the ground motion from being transferred into the building. This is the same objective as in automobile design—to keep the passengers from feeling all the bumps in the road. To accomplish this, the automobile is designed with air-inflated tires, springs, and shock absorbers to keep its passengers comfortable.

One way to do this is to put the building on roller bearings so that as the ground moves horizontally, the building remains stationary (Figure 12-8). A problem with this solution is that roller bearings would still transmit force into the building through friction. In addition, once the building began to roll, its inertia would tend to keep it moving. We need a structure that allows horizontal movement with respect to the ground, but restrains, or dampens, this movement so that as the ground vibrates rapidly, the building vibrates much more slowly with slower velocities and accelerations.

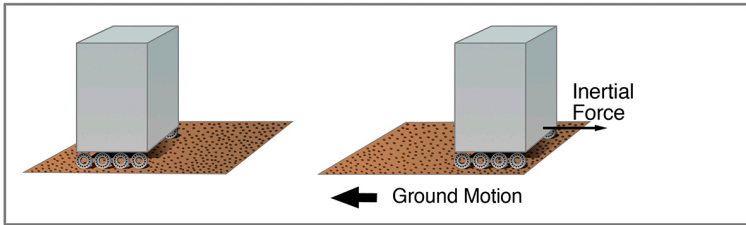
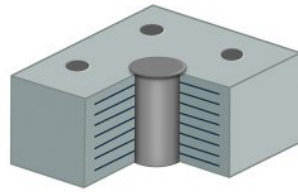

Figure 12-8. Mounting a building on roller bearings so that building remains stationary when the ground moves. The problem: how to stop it from moving. From AIA/ACSA Council on Architectural Research

The solution is to separate the requirement for load bearing (vertical loads) from that for movement (horizontal loads). One way to do this involves a lead-rubber bearing (Figure 12-9). This bearing consists of alternating laminations of rubber and steel, which allow for up to six inches of horizontal movement without fracturing but are strong enough to support the building. A cylindrical lead plug is placed in the center of this bearing to dampen the oscillations in the ground produced by an earthquake, just like the shock absorbers in a car. The energy of the earthquake waves is absorbed by the lead plug rather than by the building itself. The lead plugs do not deform in small earthquakes or high winds; in that respect, they serve as “seismic fuses.”

Lead recovers nearly all of its mechanical properties after each deformation from an earthquake. This is analogous to the solid-state ductile deformation of lower crustal rocks without producing earthquakes. The lead-



*Figure 12-9. Base-isolation bearing. Alternating laminations of rubber and steel with a lead plug in the middle. From AIA/ACSA Council on Architectural Research*

rubber bearings allow the ground under a building to move rapidly, but the building itself moves much more slowly, thereby reducing accelerations and maximum shear forces applied to the building. The building is allowed to move about six inches horizontally. A six-inch slot around the building is built for this purpose and covered by a replaceable metal grating. The damage to architectural and mechanical components of the building, and the ensuing costly repairs, are greatly reduced and, in some instances, almost eliminated.

There are some new systems, which go beyond the lead-bearing base isolator. Examples are the single and triple pendulum bearing systems. The single pendulum system maintains constant friction, lateral stiffness, and dynamic period for all levels of earthquake motion and displacements. The triple pendulum system includes three pendulum mechanisms that are sequentially activated as the earthquake motions become more intense.

Although base isolation adds to the cost of construction, some cost savings are possible within the building itself because so much of the earthquake force is absorbed at the base of the building rather than transmitted into the structure.

The Pioneer Courthouse in Portland, constructed in 1875, is the oldest surviving federal building in the Pacific Northwest, and it has been designated a National Historic Landmark. It houses the Ninth District Court of Appeals. The challenge of a seismic retrofit of this unreinforced-masonry building was to strengthen the building without totally disrupting its character, including its sandstone-block walls. The solution was base isolation, installed below the existing foundations of the building, which minimized construction in the historic sections of the structure. The retrofit was completed in 2005.

Research is underway in Japan, New Zealand, and the United States to design other methods of base isolation and other ways to dissipate seismic energy in a building. After the 1989 Loma Prieta Earthquake, the California State Legislature passed Senate Bill 920, requiring the state architect to select one new and two existing buildings to demonstrate new engineering technologies, including base isolation. The new international airport terminal in Istanbul, Turkey, is the largest base-isolation building on Earth.

## 4. Special Problems

Each large building presents its own set of design problems in surviving earthquake forces, which means that architects must consider earthquake shaking in designing a large structure in a seismically hazardous region such as the Pacific Northwest. I consider the problem of a *soft ground floors* and the issue of the *tuning fork*.

In a building with a *soft ground floor*, the ground floor is weaker than the higher floors. The ground floor is taken up by a parking garage or contains large amounts of open space occupied by a department store or hotel ballroom. Instead of load-bearing walls, these spaces are supported by columns. Building codes commonly limit the height of soft stories to two normal stories, or thirty feet. But the result is that the ground floor is less stiff (has less



*Figure 12-10. Damage to the Los Angeles County Olive View Medical Center as a result of the 1971 Sylmar, California, Earthquake. The first floor, with a lot of open space, behaved like a soft story, causing the upper floors to move relatively to the right, forcing out the stairwell. Photo by Robert Yeats*

strength) than the overlying floors. Since earthquake forces enter the building at its base and are strongest there, the soft ground floor is a “*strength and stiffness discontinuity*” that absorbs the force of the earthquake waves. Without a soft ground floor, the earthquake forces are distributed more equally throughout the entire building. With a soft ground floor, there is a tremendous concentration of forces on the ground floor and at the connection between the ground floor and the second floor. This can cause collapse or partial collapse of the higher floors, as happened at the Los Angeles County Olive View Medical Center during the 1971 Sylmar Earthquake (Figures 12-10 and 12-11). The upper floors were relatively undamaged, but the lowermost floor and basement absorbed much of the force. The acceleration came from the right, and the building was forced toward the right, almost knocking down the stairwell. The problem can be alleviated by adding more columns, stiffening the existing structure. A second problem is illustrated by Figure 12-12, in which apartments were constructed over a garage in the basement, which acted as a soft story.



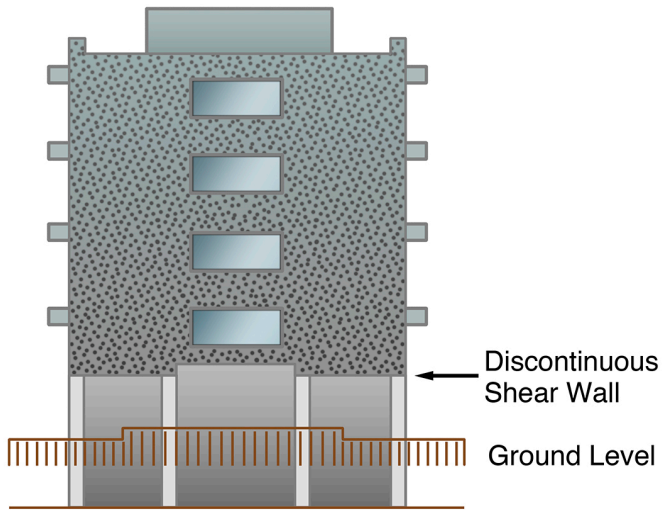

Figure 12-11. Diagrammatic representation of soft story at Olive View Medical Center. From AIA/ACSA Council on Architectural Research



Figure 12-12. Soft-story problem in apartment building where bottom floor is the garage. During 1994 Northridge earthquake, the garage acted as a soft story, and the apartments above collapsed down on the cars.

This brings us to the *tuning fork problem*. A large pipe organ has pipes of different lengths so that the organ can play different notes. The deep bass notes are played on long pipes, and the high notes are played on short pipes. A xylophone works the same way: the high notes are played on short keys, and the low notes are played on long keys. These instruments are designed to take advantage of the *vibrational frequency* of

the pipes or keys to make music. A tuning fork works in the same way. Strike the tuning fork and place it tines-up on a hard surface. You will hear a specific note, related to the length of the tuning fork, which generates sound waves of a specific frequency—the vibrational frequency of the tuning fork.

I recall a TV commercial in which a wine glass is shattered when a Wagnerian soprano sings a certain high note. Buildings work in the same way. A tall building vibrates at a lower frequency than a short building, just like a tuning fork. The problem comes when the earthquake wave transmitted through the

ground vibrates at the same frequency as the building. The building resonates with the earthquake waves, and the amplitude of the waves is intensified. All other things being the same, a building with the same vibrational frequency as the earthquake waves will suffer more damage than other buildings of different height.

In the Mexico City Earthquake of 1985, surface waves with a period of about two seconds were amplified by the soft clay underlying most of the city, which also extended the period of strong shaking. Buildings between ten and fourteen stories suffered the greatest damage, because they had a natural vibrational period of one to two seconds (Figure 12-13). When waves of that characteristic frequency pushed the foundations of those buildings sideways, the natural resonance caused an accentuation of the sideways shaking and resulted in great structural damage. In contrast, a thirty-seven-story building built in the 1950s, with a vibrational period of 3.7 seconds, suffered no major structural damage.

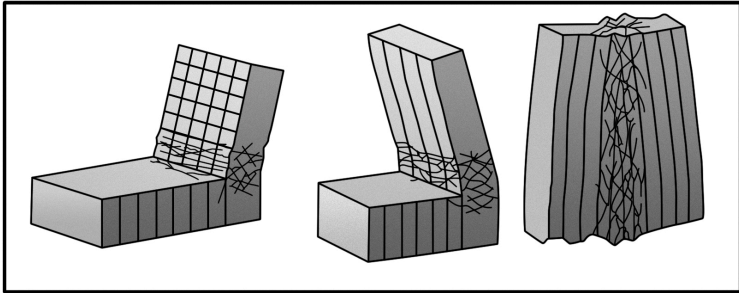

Figure 12-13. Buildings have a vibrational frequency depending on their height. If the vibrational frequency resonates with that of the earthquake waves, shaking will be amplified, and damage will be more severe, as was the case in Mexico City in the 1985 earthquake. From Bolt (2004)

## 5. Bridges and Overpasses

Freeways and bridges are lifelines, and their failure can disrupt the economy and kill people on or beneath them during an earthquake (Figure 12-14). The television images of people sandwiched in their cars in the collapse of the double-decker Interstate 880 Cypress Viaduct in Oakland, California, the collapsed span of the Oakland-San Francisco Bay Bridge, and the pancaked freeway interchanges in Los Angeles after the Sylmar and Northridge earthquakes were dramatic reminders of the vulnerability to earthquakes of highways and railroads. Structural engineers in the Bridge Division of the Oregon Department of Transportation visited the collapsed freeway overpasses after the Northridge

Earthquake, and their recommendations led to the first thorough appraisal of the earthquake potential of Oregon faults. However, most of the overpasses on Interstate 5 have not yet been repaired. As pointed out above, the 2015 Oregon Legislature failed to pass a transportation bill that would have begun retrofitting seismically-dangerous bridges that, if they failed, would cut off the Oregon coast from the Willamette Valley in a subduction-zone earthquake. The resilience survey pointed out the problem, but the legislature did nothing about it.



Figure 12-14. Damage to the Golden State Freeway (Interstate 5) and Foothills Freeway (Interstate 210) as a result of the 1971 Sylmar, California, Earthquake. Photo by E. V. Leyendecker, USGS

The double-decker Cypress Viaduct is reminiscent of

the Marquam Bridge in Portland (since retrofitted) and the Alaskan Way Viaduct in Seattle, built in 1953 for \$8 million on liquefiable soils. The Alaskan Way Viaduct was damaged in the 2001 Nisqually Earthquake and was closed for a time. Many people feared that if the shaking had lasted longer or had been of higher intensity, the viaduct would have collapsed. The Alaskan Way Viaduct is now being replaced. On the other hand, twenty-three bridges in Seattle had been retrofitted before the earthquake, and none of those were damaged.

Freeway collapses during the Northridge Earthquake caused great disruption to commuters traveling from northern and western suburbs to downtown Los Angeles. Failure of the Golden Gate Bridge and Bay Bridge could isolate San Francisco from counties north of the Bay and from East Bay cities. Bridge collapses on Highway 101 on the Oregon and Washington coast from the next subduction-zone earthquake could isolate coastal communities for an indefinite period of time, as concluded in the recent resilience surveys in both states.

Five bridges collapsed in the 1994 Northridge Earthquake. All were designed to pre-1974 standards, and none had been retrofitted. The Santa Monica Freeway had been targeted for seismic retrofit, but the earthquake got there first. In some cases, a collapsed bridge was adjacent to a recently retrofitted bridge that suffered little or no damage, even though it had been subjected to earthquake forces similar to those

endured by the bridge that collapsed. Clearly, retrofit worked for bridges and overpasses.

The problem in the older bridges was in the columns supporting the freeway superstructure. There was inadequate column confinement, inadequate reinforcement connections between the columns and the footings on which they rested, and no top reinforcement in the footings themselves. When these problems were overcome in retrofitting, bridges rode through earthquakes fairly well.

California, through Caltrans, is the nation's leader in the seismic retrofit of bridges. In 2000, Caltrans estimated that about seventeen hundred bridges in the state—about 10 percent of California's bridges—required retrofit to prevent collapse during a future strong-motion earthquake. In the Pacific Northwest, bridges such as Interstate 5 and Interstate 205 across the Columbia River and the Tacoma Narrows bridge require special consideration, because a collapse could drop a large number of vehicles and passengers into the water. The cost of retrofitting all of these bridges is prohibitive if done in a very short period of time, but both Oregon and Washington have begun the process. The resilience surveys in both states revealed that a majority of bridges in Oregon and Washington are obsolete and are subject to collapse in the forthcoming Cascadia Subduction zone earthquake. This information has been transmitted to the legislatures that authorized the surveys, but funding to fix the problem has not yet been authorized.

Which bridges to retrofit first? Establish priorities based on the potential magnitude of the loss, both directly in damages and lives lost and in economic losses, then allocate the resources to do the job.



## 6. Engineering Against Ground Displacement



*Figure 12-15. The Chi-Chi, Taiwan, earthquake was accompanied by surface rupture on the Chelungpu reverse fault. The photo is taken along the fault with the upthrown hanging wall on the left. The fault trace is between the two buildings in Fengyuan City, on which destruction was total. Photo by Charles Rubin, then of Central Washington University in Ellensburg.*

Up to this point, the main hazard discussed has been ground shaking. The Alquist-Priolo Act in California seeks to avoid construction on active fault traces (see chapter 14 for details). A large displacement of several feet, particularly vertical (dip-slip) displacement, will probably destroy a building constructed across the fault, but building foundations can be designed to survive displacements of a foot or less. It makes no difference whether the displacement is caused by faulting, ground subsidence, or incipient

landsliding. An example of building destruction in Fengyuan City due to the 1999 Chi-Chi, Taiwan, earthquake is shown in Figure 12-15. The upthrown hanging wall is to the left, and footwall is to the right.

The fault itself is close to the base of the scarp. Buildings along the hanging wall of the Chelungpu fault were totally destroyed.

Pipelines can be made flexible, and underground utility cables can have slack built in at fault crossings. The Trans-Alaska Oil Pipeline was built across a major strike-slip fault that underwent several feet of displacement in an earthquake in November 2002. After a paleoseismic study led by Lloyd Cluff of Pacific Gas and Electric Co., the pipeline was designed to accommodate strike-slip surface displacement. It survived the earthquake virtually undamaged and with no spillage of crude oil.

I recently served as a consultant on a housing development where there was potential for small-scale, distributed faulting on a large part of the property. The likelihood of a surface-rupturing earthquake was present but relatively low. The geologist determined the maximum amount of displacement expected based on backhoe excavations, and the geotechnical engineer (Jonathan Bray of the University of California Berkeley) designed building foundations that would withstand that displacement without significant damage.

## **7. Decisions, Decisions, and Triage**

The astronomical cost of retrofitting bridges brings up a major problem faced by society. As you look at the

building inventory in your town or the bridge inventory in your state, you soon recognize that in this era of budget cutbacks in government, the money is not available to retrofit even a sizeable percentage of the inventory. Decades will pass before dangerous buildings are retrofitted, with the retrofit decision commonly based on criteria other than earthquake shaking. When faced with a recommendation by two select committees to schedule the retrofit of dangerous buildings in Oregon, even over a time frame of many decades, the 1997 Oregon legislature did not act. However, a subsequent legislature passed Senate Bills 14 and 15 requiring that educational facilities from K-12 to public universities and emergency facilities, including hospitals and fire and police stations, be seismically strengthened by the year 2032. A preliminary evaluation was completed in 2007. In 2002, Oregon voters passed ballot measures to authorize the legislature to issue bonds to finance the construction required by these two bills. More recently, the Portland Public School District, the largest in Oregon, passed a bond issue with funds to retrofit old school buildings. If that work is completed before the next earthquake, children's lives will be saved. I return to this topic in the last chapter.

The decision on what to retrofit is a form of triage. In a major disaster involving hundreds of severely injured people, limited medical aid requires decisions to help first those people who are more likely to survive. In earthquake retrofitting, the triage decision would be

made to first retrofit those buildings that are most critical to the community, especially in an emergency, or structures whose destruction would be catastrophic to the population. These structures are called *critical facilities*. Let's consider the second category first.

In Chapter 6, mention was made of the nuclear reactor at the Hanford Reservation in eastern Washington.

Catastrophic failure of the reactor might result in the release of lethal amounts of radioactive gases and liquids, endangering the lives of hundreds of thousands of people, including those living downstream in Portland. Clearly, the Hanford nuclear reactor and stored nuclear wastes are critical facilities; they must be designed to meet the highest seismic design criteria even if the time of the next earthquake is not known. The large dams on the Columbia River are also critical facilities. If a dam failed during an earthquake, it would release enormous



*Figure 12-16. Van Norman Dam, San Fernando Valley, California, after the 1971 Sylmar Earthquake. About eight hundred thousand yards of the embankment, including the parapet wall, dam crest, most of the upstream slope, and a portion of the downstream slope, slid into the reservoir, causing a loss of about thirty feet of dam height. Fortunately, the dam was only about half full at the time. Eighty thousand people living downstream from the dam were ordered to evacuate, and steps were taken to lower the water level in the reservoir. Photo by E. V. Leyendecker, USGS*

volumes of water from the reservoir impounded behind

it. These dams must be designed to withstand the highest conceivable amount of seismic shaking. The Van Norman Dam in the San Fernando Valley of California came very close to failure during the M 6.7 Sylmar Earthquake in 1971 (Figure 12-16). Had failure occurred, the waters impounded behind the dam would have overwhelmed many thousands of homes downstream, resulting in the loss of thousands of lives. It was an incredibly close call.

Continuing with our triage dilemma, what facilities in your town must continue to operate after an earthquake? Certainly the command structure of local government must function, because local government leaders will direct rescue efforts and make decisions that could avert spin-off disasters that can accompany an earthquake, such as major fires and tsunamis. So we should include the police and sheriff's departments, the fire department, city hall, and the county building, including the office of county emergency management services.

How about hospitals? Several hospitals were severely damaged in 1971 (Figures 12-1 and 12-10), and injured people had to be transported to distant hospitals that had not been damaged. Schools? Most of the school children of Spitak and Leninakan, Armenia, were in their classrooms when the 1988 Spitak Earthquake struck. The classrooms were in poorly constructed, Soviet-era unreinforced-concrete buildings that collapsed, killing most of the pupils and teachers inside. There is a five- or six-year age gap in those

communities in Armenia; most of the young people of that age were killed in the earthquake.

School buildings fared badly in the 1933 Long Beach Earthquake because so many of them were unreinforced brick buildings. It was providential that there were no children in those buildings at the time of the earthquake. Had the classrooms been full, hundreds of children might have died here also. This fact became obvious to parents after the Long Beach Earthquake, leading to passage of the Field Act requiring earthquake standards for school buildings. As a result, most school buildings in California have already been replaced or recycled.

Seattle, Washington, and Portland, Eugene, and Corvallis, Oregon, have passed major bond issues to bring school buildings up to modern building codes. The Seattle School District had completed a retrofit of its aging school buildings the year before the Nisqually Earthquake. After the earthquake, District Superintendent Joseph Olchefske remarked that “Our buildings today are as secure as they could be. If this had occurred five years ago, we could have had very different vulnerabilities.”

## Acknowledgements

I am not an engineer, and I am indebted to my colleagues in the College of Engineering for reviewing

this chapter. The first edition was reviewed by Tom Miller and Steve Dickenson, and the third edition was reviewed by Andre Barbosa. Any mistakes are mine.

---

### *Suggestions for Further Reading*

- Bozorgnia, Y., and V. Bertero, editors. 2004. *Earthquake Engineering: From Engineering Seismology to Performance-Based Engineering*. Boca Raton, FL: CRC Press. Summary articles by leading experts in the field.
- Chen, W.-F., and C. Scawthorn, editors. 2003. *Earthquake Engineering Handbook*. Boca Raton, FL: CRC Press, 1,512 p.
- Earthquake Engineering Research Institute. 1996. *Construction quality, education, and seismic safety*. Oakland, CA: Earthquake Engineering Research Institute, EERI Endowment Fund White Paper, 68 p.
- Fratessa, P. 1994. *Buildings: Practical Lessons from the Loma Prieta Earthquake*. Washington, D.C.: National Academy Press.
- Krinitzky, E., J. Gould, and F. Edinger. 1993. *Fundamentals of Earthquake Resistant Construction*. Wiley Series of Practical Construction Guides. New York: J. Wiley & Sons.
- Lagorio, H. J. 1990. *Earthquakes: An Architect's Guide to*



Nonstructural Seismic Hazards. New York: J. Wiley & Sons.

Manolis, G. D., D. E. Beskos, and C. A. Brabbia. 1996. Earthquake Resistant Engineering Structures. Computational Mechanics, 728 p.

Naeim, F., ed., 2001. The Seismic Design Handbook. 2nd Edition. Kluwer Academic Publishers.

# 13. The Federal Government and Earthquakes

*“ . . . the federal government shouldn't be expected to bail people out of natural disasters because they made poor choices in where to live.”*

Dennis Mileti, University of Colorado at Boulder

*“... while earthquakes may be inevitable, earthquake disasters are not.”*

National Earthquake Hazards Reduction Program Strategic Plan, 2001-2005

## 1. Introduction

The study of earthquakes is such a large-scale problem, with so many implications, that it seems impossible for the national government *not* to become involved. The government faces two difficulties: (1) defining the earthquake problem and dedicating the national resources to deal with it, and (2) informing the public

about what has been done in such a way that the public can become a partner in reducing the earthquake hazards we face. A third difficulty, in an era when some politicians are arguing for less and less government, is convincing the public a long time after the last earthquake that the government ought to be doing anything at all. Schools? Public safety? Health care? National defense? Earthquakes? Take your pick.

## 2. Historical Background

For most of recorded history, earthquakes were regarded as unpredictable calamities, acts of God—not subjects for government involvement except for dealing with the consequences. This began to change in 1891, when a killer earthquake devastated a large section of western Japan at the same time Japan was gearing up its economy to become an equal partner and competitor with Western countries. After the 1891 earthquake, the Japanese government authorized a long-term earthquake research program, including the mapping of active faults after a major earthquake, the deployment of seismographs (which had recently been invented), and the resurvey of benchmarks across active faults and along coastlines to look for crustal deformation. The Earthquake Research Institute was established at the University of Tokyo.

As a result, Japanese earthquake scientists became

world leaders. Fusakichi Omori, at the time regarded as the world's leading seismologist, participated in the investigation of the 1906 San Francisco Earthquake. Kiyoo Wadati invented a magnitude scale before Charles Richter developed the scale that bears his name. Wadati also was the first to recognize earthquakes hundreds of miles beneath the Earth's surface, outlining what would later be known as subduction zones. Two of the leading seismologists in the United States are transplants from Japan: Hiroo Kanamori of Caltech, and the late Keiiti Aki, who had recently retired from the University of Southern California.

In the early twentieth century, seismograph observatories were established at the University of California at Berkeley, Caltech, Victoria, Seattle, and other places around the world. The Jesuits were important players, with a seismograph at Gonzaga College in Spokane, Washington. Seismology developed primarily as an academic pursuit, with earthquake research intertwined with using earthquake waves to image and explore the internal structure of the Earth. At the time of the 1949 Puget Sound Earthquake, the University of Washington had only one recently hired faculty member in seismology who was in the process of building a new seismograph in the sub-basement of the geology building, using state funds. This young man suddenly found himself in the glare of the public eye, trying to answer questions of what, where, and why.

The first federal funding for earthquake-related

research was to the U.S. Weather Bureau, which was given the assignment of collecting earthquake observations at its weather stations. The monthly weather review of the chief signal officer of the War Department was first published in 1872, and earthquake reports appeared as early as 1882. The Weather Bureau issued its own report on the 1906 San Francisco Earthquake. In several countries around the world, including Japan, the national weather service still has a major responsibility in monitoring earthquakes.

Resurveying benchmarks in California by the U.S. Coast and Geodetic Survey (later the National Geodetic Survey) led to Professor Harry Reid's elastic rebound theory for the 1906 San Francisco Earthquake on the San Andreas Fault. Both the Coast and Geodetic Survey and the Weather Bureau were part of the Department of Commerce, the only part of the federal government with a mandate to do anything at all about earthquakes. A triangulation survey by the Coast and Geodetic Survey authorized by Secretary of Commerce Herbert Hoover in the 1920s confirmed Reid's observation that the area adjacent to the San Andreas Fault was continuing to build up strain, even as it had done before the 1906 earthquake.

Aside from that, the U.S. government stayed away from earthquakes. In large part, this was because earthquakes were perceived as a California problem, and California business and political leaders played down the threat from earthquakes because they were bad for business and particularly bad for the real estate

speculation boom that was then going on. The investigation of the 1906 San Francisco Earthquake was paid for not by the government but by a private organization, the Carnegie Institution of Washington. The statements of the scientists, including those of Professor Omori, were taken out of context by the media to give the impression that the San Francisco disaster was a fire rather than an earthquake. This included a coverup: many more people died than the official documents claimed. Accordingly, no lessons were learned, and no attempts were made to strengthen buildings against earthquakes.

One positive outcome was the founding of the Seismological Society of America (SSA) in the San Francisco Bay Area, an organization that took an active role in earthquake safety. However, other SSA members were engaged in the investigation of the internal structure of the Earth, using seismic waves in the same way doctors were using X-rays to view the bone structure of the human body. These seismologists viewed the SSA as an association of academics and research scientists, and some of them were uncomfortable with the SSA taking a more political role in advocating earthquake safety.

This continued through the Roaring Twenties, during which business leaders downplayed an earthquake that heavily damaged the resort city of Santa Barbara in 1925. However, by this time, scientists were better organized, and the first building codes were enacted by the cities of Santa Barbara and Palo Alto, the latter

city the home of Stanford University, the site of much advocacy of earthquake preparedness. In 1933, the Long Beach Earthquake trashed many school buildings in the Los Angeles area, leading to state legislation mandating earthquake standards for school buildings. Still, the federal government stood on the sidelines.

This changed dramatically when the Soviets successfully tested nuclear weapons following World War II. Federal funding for seismology was not due to any concerns about earthquake hazards, but was driven by the Cold War. The United States and its NATO allies wanted to monitor Soviet (and later, Chinese) underground nuclear tests using seismographs. Seismologists showed that it was possible to distinguish between seismograms written by earthquakes and seismograms resulting from nuclear explosions, and also to determine the size and location of an underground nuclear test, just as seismologists are able to determine the magnitude and location of an earthquake.

By the early 1960s, the United States, in cooperation with other Western countries, had established a worldwide seismograph network (WWSSN), to monitor the testing of nuclear weapons, particularly after the signing of the Nuclear Test Ban Treaty in 1963. The WWSSN had a spectacular, serendipitous scientific payoff. By allowing the world's earthquakes to be located much more accurately than before, the network provided evidence that these earthquakes follow narrow bands that were found to be the boundaries of

great tectonic plates (Chapter 2, Figure 2-5). By 1966, the plate tectonics revolution had overturned the prevailing view of how the Earth works, and seismology, because of the WWSSN, had made a major contribution.

The U.S. Geological Survey (USGS) had carried out detailed investigations of major earthquakes in Charleston, South Carolina, in 1886 and in Alaska in 1899, and continued with USGS scientists participating in investigations of the 1906 San Francisco Earthquake and the 1959 Hebgen Lake Earthquake near Yellowstone Park. A team of seismologists had been assembled by the USGS in Denver to monitor the nuclear test ban. These seismologists were moved to Menlo Park, California, where they joined a team of geologists studying the great 1964 Alaska Earthquake. In carrying out these studies, the USGS was following in the tradition of the Geological Survey of India, which had studied in detail great Himalayan earthquakes in 1897, 1905, and 1934. Involvement of the USGS continued and accelerated following earthquakes in California in 1968 and 1971.

However, there was still no federal mandate for the USGS to take over the investigation of earthquakes. The only federal agency with earthquake responsibilities was still the Department of Commerce through the Weather Bureau and the Coast and Geodetic Survey. In 1947, the Coast and Geodetic Survey asked California structural engineers for advice in setting up strong-motion seismographs, and in designing buildings to be



more resistant to earthquake shaking (as well as a nuclear explosion). The engineers formed an Advisory Committee on Engineering Seismology, which by 1949 became the Earthquake Engineering Research Institute (EERI), which became a link between the SSA and professional engineering organizations. This was important because of an ongoing debate among structural engineers between those favoring more earthquake-resistant construction and those concerned about the increased costs of those measures.

Clearly, the Department of Commerce intended to keep its mandate to study earthquakes, particularly after the 1964 Alaskan Earthquake and the 1971 Sylmar Earthquake in a suburb of Los Angeles. USGS scientists had a strong interest in these earthquakes, but they could fund investigations only out of their own limited budgets, which commonly were based on the search for increased mineral resources. The Department of Commerce and the USGS issued separate government reports on each of these earthquakes.

### **3. The National Earthquake Hazard Reduction Program (NEHRP)**

Two earthquakes in 1975 strongly affected the decision to increase the involvement of the federal government

in earthquake studies. The first was the Haicheng, China, Earthquake in February 1975, which had been predicted by the Chinese early enough to reduce greatly the loss of life, although it was not recognized at the time that the Haicheng earthquake was part of an earthquake swarm (see Chapter 7). The second was an earthquake in August 1975, close to the Oroville Dam, in the foothills of the Sierra Nevada at the headwaters of the California Aqueduct. That earthquake, together with large earthquakes in China in 1962, Greece in 1966, and India in 1967—all of which had caused great loss of life—suggested that people can actually cause earthquakes by manipulating the water level of reservoirs and by the artificial pumping of fluids down boreholes for wastewater disposal or for improved recovery of oil. The Oroville earthquake finally laid to rest the view that earthquakes are acts of God in which humans play no role. The general public and, indeed, many people in the scientific community came to believe that earthquakes could be predicted and, by understanding the fluid pressures accompanying filling of reservoirs and pumping of fluids into or from wells, might even be controlled.

Several USGS geophysicists undertook a project to re-level highway markers throughout southern California, including highways crossing the San Andreas Fault. These studies suggested that the Palmdale area, in the Mojave Desert close to the San Andreas Fault, was undergoing rapid uplift. Was this part of the fault, last ruptured in 1857, about to rupture again? The

“Palmdale Bulge” was brought to the attention of Frank Press, the presidential science advisor to President Gerald Ford. This resulted in a special appropriation to the USGS to study the Palmdale Bulge and opened the door for a larger USGS role in earthquake studies. The USGS, in turn, provided research funds for university scientists, including myself, to participate in this study, thereby enlarging the earthquake research talent pool nationwide.

The battle between the Coast and Geodetic Survey and the USGS over control of federal research dollars came to an end after the Geodetic Survey was taken over by the National Oceanic and Atmospheric Administration (NOAA). The first priority for NOAA was the sea, and budget cuts led NOAA to give up the fight in favor of the USGS.

This led to passage of the Earthquake Hazards Reduction Act of 1977 (Public Law 95-124), which directed the president to establish a *National Earthquake Hazards Reduction Program* (NEHRP, pronounced “Neehurp”). Among the objectives written into the law were (1) retrofitting existing buildings, especially critical facilities such as nuclear power plants, dams, hospitals, schools, public utilities, and high-occupancy buildings; (2) designing a system for predicting earthquakes and for identifying, evaluating, and characterizing seismic hazards; (3) upgrading building codes and developing land-use policies to consider seismic risk; (4) disseminating warnings of an earthquake, and organizing emergency services after

an earthquake; (5) educating the public, including state and local officials, about the earthquake threat, including the identification of locations and buildings that are particularly susceptible to earthquakes; (6) focusing existing scientific and engineering knowledge to mitigate earthquake hazards, and considering the social, economic, legal, and political implications of earthquake prediction; and (7) developing basic and applied research leading to a better understanding of control or modification of earthquakes.

Objective (6) contains a word, *mitigate*, which might be unfamiliar to many, but which appears so often in public statements as well as legislation that a definition should be presented here. To mitigate means to *moderate, to make milder or less severe*. The earthquake program thus does not take on the job of eliminating the earthquake threat, but rather of moderating the problem—an important distinction.

Ironically, three of the main arguments for establishing NEHRP did not prove to be worthwhile avenues of investigation. As discussed in Chapter 7, earthquake prediction is as far away from being achieved today as it was in 1977. Earthquake control is no longer taken seriously, as discussed further below. Finally, the Palmdale Bulge was re-analyzed, and it was found that most of the uplift signal was an artifact of survey error. Subsequent investigations using much more sophisticated space geodesy did not confirm the existence of a bulge.

Although the 1977 law included several non-research

objectives such as public education and upgrading of building codes, the legislation was primarily pointed toward research. The bill authorized new appropriations for two agencies, the USGS and the National Science Foundation, to conduct or to fund earthquake-related research through grants and contracts to universities and other non-governmental organizations. The legislation did not indicate how the non-research objectives were to be implemented. Instead, the president was directed to develop a plan for implementation. Furthermore, the legislation left unclear which agency was in charge.

The president's implementation plan, sent to Congress in 1978, gave much of the responsibility for implementation of Public Law 95-124 to a lead agency, but, as in the law itself, the lead agency was not specified. A multi-agency task force was given the responsibility to develop design standards for federal projects. In the following year, Executive Order 12148, dated July 20, 1979, designated the newly created Federal Emergency Management Agency (FEMA) as the lead agency. This decision was included in 1980 in the first reauthorization legislation for the earthquake program. This legislation included a fourth agency, the National Bureau of Standards, later to be renamed the National Institute of Standards and Technology (NIST), as an integral—although small—part of NEHRP. The Department of Commerce had once been the only federal agency with a mandate to study earthquakes, but under NEHRP, NIST was the only part of the

Department of Commerce to retain its federal mandate, and its role at that time was relatively small. However, NIST is now the lead agency for NEHRP, with an increased budget accompanied by increased responsibilities.

NEHRP was reauthorized five more times without significant change in the scope of the program. But by 1990 it was clear that Congress intended to make some changes. During the 1980s, it became apparent that the goal of earthquake prediction was not going to be achieved in the immediate future, as described in Chapter 7. The 1987 Whittier Narrows Earthquake struck Los Angeles and the 1989 Loma Prieta Earthquake struck the San Francisco Bay Area; neither had been predicted. Furthermore, as indicated in the Senate report accompanying the 1990 reauthorization bill, the application of NEHRP research findings to earthquake preparedness was considered slow and inadequate. The efforts of the four agencies were perceived as uncoordinated and unfocused. Finally, the goal of earthquake control was criticized as unrealistic and unattainable in the near future.

A mental exercise illustrates the problems facing the goal of earthquake control. An experiment in 1969 had shown that small earthquakes in an oil field at Rangely, Colorado could be turned on and off by increasing the amount of water injected into or withdrawn from the oil field. When water was withdrawn, earthquake activity decreased. The added water pressure along existing faults in the oil field increased fluid pressure in the

fault zones and caused them to move, producing small earthquakes. As in the case of filling the reservoir behind Oroville Dam, human activity was shown to have an effect on earthquakes.

The suggestion was then made: could this be done on a larger scale at a major fault, where the results could mitigate the earthquake hazard? Specifically, could it be done for the San Andreas Fault? The idea was simple: drill several very deep boreholes along the thinly populated 1857 rupture zone of the San Andreas Fault in central California and inject water, thereby weakening the fault. The idea was to weaken the fault enough to trigger a smaller earthquake of, say, M 6.5 to M 7 rather than wait for another earthquake as large as the 1857 rupture, which was M 7.9. The smaller earthquake, or series of smaller earthquakes, would cause much less damage than a repeat of the 1857 earthquake. It would be the earthquake equivalent of a controlled burn to alleviate hazard from forest fires.

There are two problems with this idea. First, the cost of drilling the holes for injection of water would be exorbitantly high—many millions of dollars to inject water deep enough to have an influence on the earthquake source ten miles or more beneath the surface. Second, what would be the legal implications of a triggered earthquake? What is the legal recourse for a person whose home or business is severely damaged in a triggered M 7 earthquake as opposed to the next M 7.9 earthquake, which might not have struck during his/her lifetime? What about the possibility of people

being killed during the smaller event? Questions such as these led to the conclusion that earthquake control was not attainable in the near future, at least not by injecting fluids into a major, active fault zone. Returning to the forest-fire analogy: a controlled burn in the spring of 2000 went out of control and did severe damage to the town of Los Alamos, New Mexico. The legal fallout from that was, and is, sobering.

The 1990 reauthorization bill passed by Congress eliminated some references to earthquake prediction and control, and it expanded efforts in public education and in research on lifelines, earthquake insurance, and land-use policy. It marked the beginning of the shift from a predominantly research program toward a broader-based program including implementation and outreach. The role of FEMA as lead agency was clarified, including presentation of program budgets, reports to Congress, an education program, and block grants to states. New federal buildings were required to have seismic safety regulations, and seismic standards were established for existing federal buildings.

The amount allocated for NEHRP was less than \$60 million in fiscal year (FY) 1978 and around \$100 million in FY 1994. In terms of constant 1978 dollars, the program received less money in 1994 than it did at its start-up in 1978. This problem has continued to the present day, exacerbated by the political conflicts in Congress over the national debt, to which one response was the budget sequester. In addition, there was commonly a disparity between the amount *authorized*



and the amount actually *appropriated* by Congress. This disparity was greatest in FY 1979 and 1980, and again in FY 1992 and 1993, and continues to the present day. The effect of individual earthquakes was apparent. The only boost in constant dollars came in 1990 after the Loma Prieta “World Series” Earthquake in the San Francisco Bay Area, and the only time in the past ten years that appropriations were the same as authorization was after the Northridge Earthquake of 1994. On the other hand, the Landers Earthquake, which struck a thinly populated area in the Mojave Desert of California in 1992, had no impact on funding, even though it was larger than either the Loma Prieta Earthquake or the Northridge Earthquake.

The lesson here is that politicians respond to an immediate crisis, but they have short memories for solving the problem in the long haul—particularly after the last earthquake fades into memory. It is again a difference in the perception of time, as discussed in Chapter 1. To an Earth scientist, the 1987, 1989, 1992, 1994, 1999, and 2003 California earthquakes and the 2001 Nisqually Earthquake are part of a continuum, a response to the slow but inexorable movement of tectonic plates. To a public official, and indeed to the public at large, each earthquake is an instant calamity that must be dealt with in the short term, without serious consideration for when and where the next earthquake will strike.

We now consider the role of individual federal agencies, first those officially part of NEHRP, and then

other agencies that play an important role in earthquake research but are not an official part of NEHRP.

## 4. Federal Emergency Management Agency (FEMA)

The Federal Emergency Management Agency (FEMA) had its beginnings in 1950 with the establishment of the Federal Civil Defense Administration, a response to the growing nuclear threat from the Soviet Union during the Cold War. FEMA has two roles within NEHRP: (1) leading and coordinating NEHRP, a responsibility reassigned to NIST in 2005, and (2) implementing mitigation measures. In the early years of its involvement in the program, it was mainly a coordinator rather than a leader, resulting in criticism in congressional hearings before the 1990 and 1994 reauthorization bill. By 1994, FEMA's leadership responsibilities included (1) preparation of NEHRP plans and reports to Congress, (2) assessment of user needs, (3) support of earthquake professional organizations, (4) arranging interagency coordination meetings, (5) support of problem-focused studies, and (6) outreach programs, especially for small businesses.

In its implementation role, FEMA contributes to developing standards in new construction and retrofits,

and to applying engineering design knowledge to upgrading building codes. FEMA has provided grants to state governments and to multi-state consortia to support hazard mitigation, including not only earthquakes but floods, wildfires, hurricanes, and other disasters. Activities include education, outreach, adoption of building codes, and training exercises. In the Northwest, these activities are coordinated by the FEMA Region X office in Bothell, Washington; in California, it is done by the Region IX office in Oakland.

FEMA (and later NIST) played the lead role in preparing the federal government for national emergencies. Public Law 93-288 established a Federal Response Plan to coordinate federal assistance in a large-scale disaster in which the resources of participating federal agencies would be necessary. The Federal Response Plan outlines the responsibilities, chain of command, and sequence of events for federal and local authorities to deal with the emergency.

When the president declares an area struck by an earthquake to be a major disaster area, FEMA swings into action. A coordinating officer is appointed, who sets up a disaster field office to manage the response and recovery, including rescue and small loans and grants to businesses or individuals. The disaster field office coordinates response from other federal agencies, the state emergency services agency, and the Red Cross. The emergency response team deals with twelve support functions: transportation, communications, public works/engineering,

firefighting, information and planning, mass care, resource support, health/medical services, urban search and rescue, hazardous materials, food, and energy.

In most cases, the governor of a state requests that the president declare a disaster area, unless the disaster affects mainly federal property, as was the case in the Oklahoma City bombing. The disaster declaration varies from one disaster to the next. So far, in the presidential declarations that have been issued in the past few years, this arrangement has worked reasonably well. However, the system has yet to be tested by an earthquake as large as the 1906 San Francisco Earthquake or a M 9 subduction-zone earthquake.

In 1997, FEMA started Project Impact, a plan to build disaster-resistant communities. The strategy was to build partnerships with local government, private companies, and individuals to prepare a community for a disaster before it happens, rather than simply picking up the pieces afterwards. With assistance from FEMA, communities do their own planning rather than accept a plan dictated by Washington. Communities submitted proposals to FEMA for support.

Seattle was one of the first communities selected, starting with a grant of \$1 million in 1998. The hazards selected were primarily earthquakes and landslides. The focus was on retrofitting homes and schools and on hazard mapping, including those parts of the city with steep slopes that might be more vulnerable to

landslides. The plan emphasized public education and outreach, so that homeowners and school board members could learn what they needed to do; in the case of schools, teams of volunteers helped make classrooms safer against earthquakes. Information about retrofitting was made available to surrounding communities as well as to businesses. Bellevue, across Lake Washington from Seattle, has been very proactive even though it was not a recipient of Project Impact funding.

Project Impact was given credit for improving Seattle's response to the Nisqually Earthquake, greatly reducing losses to homes and schools. However, in a twist of fate, the earthquake struck on the same day that Vice President Dick Cheney was announcing on CNN that Project Impact was being terminated! In response, Senator Patty Murray called CNN and stated, "I'm shocked and outraged. I have been on the ground here in the Pacific Northwest for the last three days examining the aftermath of this earthquake, and there is a stark contrast between the damage done to communities that have prepared for natural disasters and those that have not."

In fairness, Project Impact was not intended to be a permanent source of funding for any one community. However, as a result of the Nisqually Earthquake, additional funds were provided, although the emphasis shifted to planning as a result of the Disaster Mitigation Act of 2000. Funds provided under Project Impact required communities to have a FEMA-approved

mitigation plan in place by November 1, 2004. The first jurisdiction in the United States to develop a FEMA-approved plan was Clackamas County, Oregon, part of the Portland metropolitan area and a former recipient of Project Impact funds.

In 1997, FEMA started an initiative called HAZUS (Hazards United States), under a cooperative agreement with the National Institute of Building Sciences (NIBS). HAZUS uses a software program (newest version: HAZUS MH 2.2, compatible with Windows 7 and 8) to map building inventories, soil conditions, known faults, and lifelines to estimate economic losses and casualties from a disaster. Technical assistance is available at [FEMAMapSpecialist@riskmapcdfs.com](mailto:FEMAMapSpecialist@riskmapcdfs.com). HAZUS was used for a study of the Portland, Oregon, and Reno-Carson City, Nevada, metropolitan areas. It has expanded nationwide, building from local census tract data. It requires ArcGIS and ArcView. MH stands for Multi-Hazards, including floods, hurricanes, coastal surges, and earthquakes. Its website is [www.hazus.org](http://www.hazus.org).

FEMA's programs represent a shift in focus from *hazard*—where the faults are, how big the earthquakes will be on these faults, and how the ground will respond—to *risk*—what the losses will be on a future earthquake. For example, the 1992 Landers Earthquake (M 7.3) in the Mojave Desert was a big hazard but did not represent a big risk because of the low population in the affected area. On the other hand, the 1987 Whittier Narrows Earthquake (M 5.9) was a much

smaller hazard but a larger risk because it struck in the middle of Los Angeles.

FEMA has estimated that projected average annual earthquake losses in Washington and Oregon would be almost \$400 million, the largest amount outside of California and nearly one-tenth of the total for the United States. Washington ranks second in the U.S. with \$228 million, and Oregon is third with \$167 million, twice as high as the next state, which is New York. Nearly half of Washington's annual losses are in Seattle, and half of Oregon's losses are in Portland, reflecting the large building inventory in those cities. On the other hand, the highest *per capita* annual losses are in the coastal counties of the Northwest, reflecting their proximity to the Cascadia Subduction Zone.

These losses include capital losses, that is, repair and replacement costs for structural and nonstructural components, including building contents and inventory, and losses of income due to business interruption. The loss estimates take into account the quality of building construction. For example, there are many buildings in Seattle and King County that predate modern building codes that require them to be bolted to their foundation. The projected average annual losses for a region can be compared to the annual increase in construction costs due to higher earthquake standards in building codes; this has led to controversy in the St. Louis-Memphis area.

In 2003, FEMA released HAZUS-MH to assist HAZUS users in employing the relatively sophisticated loss-

estimation software. FEMA has established a program administered through the private sector to provide training and technical assistance to new HAZUS users. For information about training courses, go to [training.fema.gov/emiweb](http://training.fema.gov/emiweb)

As a response to the war on terrorism, FEMA became part of the Department of Homeland Security (DHS), adding human-made disasters (terrorist attacks) to natural disasters. This move has not been without its critics. At a Congressional hearing on May 8, 2003, Robert Olson, former executive director of the California Seismic Safety Commission, stated, “How the leadership responsibility will be performed within the new and huge DHS is of some concern to the earthquake community.” Members of Congress also expressed concern that the shift to DHS might result in loss of visibility for NEHRP.

However, Anthony Lowe, director of the mitigation division of the Emergency Preparedness and Response Directorate of DHS, defended the transfer and asked for a chance to show that it would lead to “an unprecedented opportunity” for the earthquake program, in part “because of the ability of earthquake design to address man-made intrusions.”

In September 2003, Hurricane Isabel tested the new organization. While the hurricane was still offshore, DHS Secretary Tom Ridge, himself a former governor, appeared on TV to explain the government’s plans. The response was efficient, including the use of volunteers, although there were long lines of people awaiting



assistance, similar to those after the Northridge Earthquake. One FEMA staff member told me, “It works the same way as before. We just have another boss.” On the other hand, the federal response to Hurricanes Katrina and Sandy was criticized as uncoordinated and politicized, and the coordination between the federal government and the states of Louisiana, New York, and New Jersey has not been a model of efficiency.

## 5. U.S. Geological Survey

The USGS receives nearly half of NEHRP funding. Funds are used to pursue four goals: (1) understanding what happens at the earthquake source, (2) determining the potential for future earthquakes, (3) predicting the effects of earthquakes, and (4) developing applications for earthquake research results. Research ranges from fundamental earthquake processes to expected ground motions to building codes.

More than two-thirds of NEHRP funding is spent internally to support USGS scientists in regional programs, laboratory and field studies, national hazard assessment programs, and the operation of seismic networks, including the Pacific Northwest Seismograph Network operated with the University of Washington, the Northern California network operated with the University of California at Berkeley, and the Great Basin network operated with the University of Nevada-Reno.

The remainder is spent on grants to universities, consulting firms, and state agencies, and partial support of the Southern California Earthquake Center. The external grants program is based on objectives established within the USGS with advice from outside. Grant proposals must address one or more of these objectives, which may change from year to year. The external grants program involves the best minds in the country, not just those of government scientists, to focus on earthquake hazard mitigation.

Much of the geographic focus has been on California. But starting in the mid-1980s, the USGS began a series of focused studies in urban areas at seismic risk, starting with the Salt Lake City urban corridor. After the recognition that the Pacific Northwest faced a major seismic threat, based largely on the research of USGS scientists, the Puget Sound-Portland metropolitan region was selected for a focused program that is still in progress. The results of this program were summarized in the 1990s in the two-volume USGS Professional Paper 1560, *Assessing Earthquake Hazards and Reducing Risk in the Pacific Northwest*. However, the San Francisco Bay Area and metropolitan Los Angeles continue to receive major research emphasis.

The Pacific Northwest program is managed from a USGS office in Seattle at the University of Washington directed by Craig Weaver; other USGS scientists working on Pacific Northwest problems are stationed in Vancouver, Washington (Cascade Volcano

Observatory), Menlo Park, California, Denver, Colorado, and Reston, Virginia.

Although this program has worked amazingly well over the past two decades, it nearly ran off track in 1995–96 as a result of the Contract with America from the new Republican majority in Congress. One of the objectives of the Contract was to eliminate several government agencies, and the USGS was on the hit list. As the USGS fought for its existence and tried to save the jobs of permanent staff members, the external-grants program of NEHRP suddenly found itself eliminated by a committee in the House of Representatives. The program was later restored, thanks to assistance from Senators Mark Hatfield (R., Oregon), Slade Gorton (R., Washington), and Barbara Boxer (D., California). But before grants could be awarded, the government was temporarily shut down in early 1996, and the Department of the Interior, which includes the USGS, was forced to operate by continuing resolutions of the Congress for most of FY 1996 at significantly lower-than-normal appropriations. A year of earthquake research was lost.

A similar problem emerged in the fall of 2013, when disagreements between Congress and President Obama caused the government to shut down for sixteen days. Again, work came to a halt, and the long-term effects of that shutdown are still unclear.

The USGS assisted in organizing the Cascadia Region Earthquake Workgroup (CREW), an organization discussed in the following chapter. The USGS also

operates the National Earthquake Information Center in Golden, Colorado, to locate damaging earthquakes around the world as rapidly as possible and to collect and distribute seismic information for earthquake research.

Congress has given the USGS the job of developing a real-time alert system, and, in addition, the USGS is developing an Advanced National Seismic System (ANSS) with new state-of-the-art instruments for better location and characterization of earthquakes, including the effect of earthquakes on buildings and structures. A related program is EarthScope, in which a band of seismometers was begun on the West Coast and subsequently expanded eastward across the country. This program has been managed by individual universities, starting with Oregon State University at its inception. Also under USGS direction is a project called Did You Feel It? in which people feeling an earthquake log onto a website and record their observations. Based on these observations, a seismic intensity map is published.. The Did You Feel It? map for the Nisqually Earthquake of 2001 is shown as Figure 3-16.

## **6. National Science Foundation (NSF)**

The National Science Foundation (NSF) receives about 30 percent of NEHRP funding, divided into two areas, administered by two directorates within NSF. The

largest amount goes to earthquake engineering, including direct grants to individual investigators. Part of the budget goes to three earthquake-engineering research centers in New York (established in 1986), Illinois, and California (both established in 1997). The Pacific Earthquake Engineering Research Center (PEER) in Richmond, California is operated by the University of California at Berkeley, one of the leading institutions in the world for earthquake engineering research.

The George E. Brown, Jr., Network for Earthquake Engineering Simulation (NEES), headquartered at Purdue University in West Lafayette, Indiana, is a new NSF program to test the response of buildings to earthquakes. Ideally one would subject a building to actual shaking, and commonly this is done by putting it on a foundation that shakes, but the building size is limited. NEES does it by computer simulation. More information is available at <http://www.nees.org>

Part of the budget of the engineering research centers comes from NSF, but an equal amount is expected to come from other sources. The Buffalo, New York, center has received money from the Federal Highway Administration for research into the seismic vulnerability of the national highway system. Other research includes geotechnical engineering studies of liquefaction, tsunamis, and soil response to earthquakes, and the response of structures to ground motion. The NEES center in the Pacific Northwest is located at Oregon State University and includes the

O.H. Hinsdale Tsunami Wave Tank Laboratory, one of the largest tsunami wave tanks in the world, where experiments are conducted on the effects of tsunami waves on buildings. A category called earthquake systems integration includes research in the behavioral and social sciences and in planning, including code enforcement and how to decide whether to demolish or repair a building.

The directorate of NSF that includes the geosciences funds grants to individual scientists and to three university consortia—the Incorporated Research Institutions for Seismology (IRIS), the Southern California Earthquake Center (which also receives support from the USGS), and the University Navstar Consortium (UNAVCO), which provides technical assistance and equipment for geodetic studies of crustal deformation using GPS. IRIS is building a global network of state-of-the-art digital seismographs. IRIS provides NEHRP with assessments of the frequency of earthquakes worldwide and their expected ground motion. It is developing a program to deploy seismographs in the field immediately after a large earthquake or volcanic event. The Data Management Center of IRIS is housed in Seattle. IRIS also prepares summaries (teachable moments) of major earthquakes worldwide, using the seismograph at the University of Portland operated by Robert Butler and videos prepared by Jenda Johnson and Robert Butler.

Direct grants from NSF to individual investigators include research into the study of earthquake sources,

of active faults and paleoseismology, and of shallow crustal seismicity. In FY 1990, instrument-based studies in seismology and geodesy received the bulk of the funding.

Although the Ocean Sciences Directorate in NSF has no focused program in earthquake studies, projects attached to oceanographic cruises with other primary objectives have made important discoveries, including a set of seafloor faults that cut across the Cascadia Subduction Zone, discovered in an NSF-sponsored cruise in preparation for a research drilling program off Cascadia in 1992. A set of seismic-reflection profiles, also preparatory to the drilling project, imaged the plate-boundary fault directly (cf. Figures 4-2, 4-4). Tube worm and clam communities in the vicinity of the Cascadia Subduction Zone were discovered on a cruise to work out the migration of fluids in subduction zones; those fluids were found to travel along active faults. The new Integrated Ocean Drilling Program includes major research on subduction zone earthquakes, including a project to acquire cores within the subduction-zone fault itself. The Japanese coring vessel *Chikyu* has sampled the source fault of the March 2011 Tohoku-oki Earthquake.

## 7. National Institute of Standards and Technology (NIST)

The National Institute of Standards and Technology (NIST), the old National Bureau of Standards and part of the Department of Commerce, had received the least amount of funding of the four agencies comprising NEHRP. Its main role had been in applied engineering research and in code development. Its initial budget for earthquake research was less than \$500,000 per year and stood at \$1.9 million. In FY 1994, it received a supplemental appropriation to respond to the Northridge Earthquake, resulting in a budget of \$3.6 million. The 1990 reauthorization directed NIST to carry out “research and development to improve building codes and standards and practices for structures and lifelines.”

In 2004, NEHRP was reorganized; NIST was made the lead agency and was directed to establish the Advisory Committee on Earthquake Hazard Reduction (ACEHR), which conducts research in earthquake engineering as well as coordinating the activities of the other three agencies. Most of the members of this committee are not federal employees.



## 8. National Oceanic and Atmospheric Administration (NOAA)

The agencies discussed in this section are not part of NEHRP. Yet two of them contribute significantly to earthquake research because of their technological focus on the sea (National Oceanic and Atmospheric Administration, NOAA) and space (National Aeronautics and Space Administration, NASA). There are, of course, many informal working relationships between these agencies and NEHRP, but the lack of formal structure can lead to a lack of focus. Nonetheless, both NOAA and NASA have managed to make critical contributions to an understanding of earthquakes and earthquake-hazard mitigation.

NOAA is part of the Department of Commerce, which until the early 1970s was the only government department, through the U.S. Coast and Geodetic Survey and the National Weather Bureau, with a federal mandate to study earthquakes. After a battle with the USGS for primacy in earthquake funding, the Department of Commerce withdrew from the field in the early 1970s, and the USGS took over, as discussed earlier in this chapter. This might have been a reason NOAA was excluded from NEHRP in 1977.

NOAA is the principal federal agency responsible for tsunami hazards (see Chapter 9). Earthquake and tsunami data are distributed through its National Geophysical Data Center in Colorado. NOAA also

provides real-time tsunami warnings for the United States and its territories through tsunami warning centers in Alaska and Hawaii (described in Chapter 9). After a tsunami generated by the 1992 Cape Mendocino Earthquake was detected on the northern California coast, Congress gave NOAA additional funds and responsibilities and established the National Tsunami Hazard Mitigation Program, designed to reduce risks from tsunamis. NOAA is the lead federal agency in this initiative, with participation by FEMA, USGS, and NSF (Chapter 9).

The U.S. Navy has declassified arrays of hydrophones (called SOSUS) on the sea floor that were used during the Cold War to monitor military ship traffic in the oceans and has allowed these hydrophones to be used by NOAA. These hydrophones, in addition to recording ship engine noise and whale calls, monitor earthquake waves transmitted directly through water, called T-phase waves. These waves locate earthquakes on the sea floor with much higher accuracy and to a much lower magnitude threshold than is possible from land-based seismographs. Furthermore, NOAA has located many times the number of earthquakes on the deep ocean floor than the land-based seismograph network.

Just as the USGS is responsible for topographic mapping on land, NOAA is responsible for mapping the topography (*orbathymetry*) of the sea floor using a ship-borne mapping device called SeaBeam. Earlier mapping techniques relied on individual soundings of water depth, followed later by profiles of the sea floor by

depth recorders mounted in the hulls of passing ships. SeaBeam and similar technologies developed by the British, French, and Japanese map a swath of sea floor based on the echoes of sounds transmitted from several locations mounted in the ship's hull. NOAA swath bathymetry results in topographic maps of the sea bottom comparable in accuracy to topographic maps of dry land constructed by the USGS.

Once thought to be a barren, featureless landscape, the sea floor is now known to be marked by canyons, great faults, volcanoes, landslides, and active folds (Figures 2-4, 4-4, and 8-14). Tectonic features of the deep ocean floor are not altered by erosion to the degree that land structures are. The bathymetry is recorded digitally so that it can be displayed as a computer model in which the water has been stripped away, as shown in Figures 4-4 and the offshore part of Figure 8-14. (Similarly, the USGS has digitized its land topographic maps permitting a new and revealing perspective on the tectonic forces that produce the topography above sea level, as illustrated in Figures 4-5, 6-11, 6-24, 6-25, and the onshore portion of Figure 8-14.) SeaBeam bathymetry directs submersibles with observers and remote-controlled robotic vehicles to observe and map faults on the sea floor. An active research program involving submersibles, funded by NOAA's National Undersea Research Program (NURP), has led to new detailed information on the Cascadia Subduction Zone and active faults and folds on the continental shelf and slope.

Because NOAA is not part of NEHRP, programs such as NURP earthquake hazards research and SeaBeam bathymetric mapping are at risk from budget cutters because except for tsunamis, earthquake hazard research is not a primary mission of NOAA.

## **9. National Aeronautics and Space Administration (NASA)**

When LANDSAT cameras returned images of the Earth from space several decades ago, it changed our perspective forever. Faults such as the San Andreas were viewed in unprecedented clarity, and other, previously unknown earthquake-producing structures were also revealed. The Geodynamics Program at NASA was developed to take advantage of the new space platforms as a means to learn about the Earth, including plate tectonics, mineral resources, and an understanding of earthquakes. These activities are now coordinated in a program called Earth Systems Enterprise, managed by the Jet Propulsion Lab in Pasadena.

In December 1999, NASA launched a satellite named Terra, the Earth Observing System, to map the Earth in real time, tracking changes on the Earth's surface observed from space. In February 2000, the space shuttle Endeavour conducted an eleven-day radar

mapping survey of the Earth, resulting in much more accurate topographic maps than had been available previously.

The greatest impact NASA has had on earthquake research has been in the measurement of crustal strain from space (described in Chapter 3). This includes the measurement of the relative motion of radio telescopes based on measuring signals from quasars in outer space, the measurement of strain through the Global Positioning System based on signals from NAVSTAR satellites, and the direct measurement of displacement during an earthquake based on radar interferometry. Much of this work is coordinated through NASA's Jet Propulsion Lab. Radar interferometry revealed an area of rising crust west of the South Sister volcano in Oregon, a suggestion that magma was moving upward beneath the Earth's surface. Three satellites provide radar data, two from Europe and one from Canada.

## 10. Other Federal Agencies

Earthquake research by other non-NEHRP agencies principally involves the earthquake safety of those critical facilities that are their responsibility. The *Nuclear Regulatory Commission* (NRC), the successor to the Atomic Energy Commission of the 1960s, has sponsored research into earthquake hazards related to the safety of nuclear power plants. With a nuclear

power plant at St. Helens, Oregon (since shut down) and unsuccessful efforts to build plants at Satsop, Washington, east of Aberdeen, and in the Skagit Valley of Washington, the NRC was the first federal agency to take a direct interest in evaluating the earthquake hazard of the Pacific Northwest, in the 1970s. The *Department of Energy (DOE)* has also been involved in the earthquake safety of nuclear power plants as well as the Yucca Mountain site proposed for nuclear waste disposal and the Hanford Nuclear Reservation in Washington, where cleanup operations are underway.

Dams are critical facilities as well, and this has resulted in research by the *Army Corps of Engineers* and the *Bureau of Reclamation of the Department of Interior*. These agencies, together with the *Veterans Administration*, have been responsible for installing instruments to measure strong ground motion. The *Department of Defense* has funded investigations through the Office of Naval Research and the Air Force Office of Scientific Research, which provides some support for IRIS and other seismic monitoring for nuclear test ban compliance.

The *Small Business Administration (SBA)* provides disaster relief loans to qualifying small businesses. After the Northridge Earthquake, the average SBA loan for repair of property damage was \$66,100 and the average loan for economic recovery was \$34,400.

## II. The Pacific Northwest Seismograph Network

Although this network is operated by the University of Washington, it is discussed in this chapter because most of its funding comes from the federal government. A smoked-paper seismograph was installed in Science Hall on the University of Washington campus in 1906, the first seismograph in either Washington or Oregon. Various faculty members in the Department of Geology transmitted earthquake information to the federal government (Weather Service). The seismograph was moved, along with the rest of the Department of Geology, to Johnson Hall in 1930.

In 1948, a Finnish seismologist, Eijo Vesanen, was hired to upgrade the seismograph; he was still building the new seismograph when the Puget Sound Earthquake struck in 1949. Vesanen decided to return to Finland, and he was replaced by Frank Neumann, the recently retired chief of the Seismology Branch of the Coast and Geodetic Survey. Neumann recognized that the Johnson Hall site on glacial sediments was a poor substitute for a site on bedrock, and in 1958, using university funds, he established bedrock sites at Longmire, in Mount Rainier National Park, and Tumwater, near Olympia.

When the national decision was made to establish the WWSSN network of seismograph stations to monitor nuclear testing by the Soviet Union, Neumann was

successful in getting a grant from the Coast and Geodetic Survey to establish a WWSSN station at Longmire. The new station began functioning in 1962, with Park Service personnel changing the records and mailing them weekly to the Department of Geology. However, the grant required that the responsible seismologist hold a PhD degree, which Neumann did not have. Norm Rasmussen, with a MS in geology, was hired as a technician until a permanent replacement for Neumann could be found.

Bob Crosson arrived in 1966 as the university was applying successfully to the National Science Foundation (NSF) for a Science Development Grant. The seismology part of this grant went to the newly established geophysics program. Funding became available in the late 1960s, and Crosson began to build the network, obtaining additional grants from NSF to do so. By the end of 1970, there were five stations transmitting data electronically to the University of Washington; by the end of 1979, there were twenty-three stations in western Washington. The first scientific paper describing the seismicity of western Washington based on network data was published by Crosson in 1972.

The NSF science development grant was not intended to be a permanent source of funding for the network. After the USGS took over responsibility for earthquakes from the Department of Commerce, funding the Washington network shifted to USGS, along with other networks in the western United States.



A separate USGS network at Hanford Nuclear Reservation began locating earthquakes in 1970; in 1975, this network began transmitting data directly to the University of Washington, as did the Jesuit station at Gonzaga University. Another network was set up around Mt. St. Helens after it erupted in 1980; this network was also folded into the Washington network at Seattle. The eastern Washington and western Washington networks were merged in the 1980s.

In Oregon, a seismograph station was built at Corvallis in 1950. This was replaced by a WWSSN station in 1962 that is now part of the IRIS network. The University of Oregon established several stations in the early 1990s. At the present time, Oregon and Washington are covered by the Pacific Northwest Seismograph Network, although station density in eastern Oregon and eastern Washington is low.

## **12. Role of the Canadian Government**

The government of Canada, through the Geological Survey of Canada (GSC), which is part of the Department of Natural Resources Canada, is responsible for virtually all earthquake monitoring in Canada as well as the collecting and archiving of earthquake data, routine analysis of data, and provision of earthquake information to the public. The GSC is responsible for earthquake research and the

production of earthquake hazard maps for use in the National Building Code.

The first seismograph (one of the first in the world) was built in Victoria in 1898, recording its first earthquake eight days later. This seismograph was operated by Francis Denison of the Meteorological Service of Canada, who recorded and described the M 7 earthquake on December 6, 1918 on the west coast of Vancouver Island. Denison built and installed additional seismographs. In 1939, responsibility for seismograph stations was transferred to the federal Department of Mines and Resources. An earthquake of M 7.3 on June 23, 1946 and Canada's largest historical earthquake of M 8.1 off the Queen Charlotte Islands in 1949 led to the transfer of seismologist W. G. Milne from Ottawa to the west coast. Milne established a seismograph network and began publishing catalogues of earthquakes. His work led to Canada's first seismic zoning map, incorporated into the National Building Code in 1970.

In 1975, digital recording of seismic data began, with signals telemetered to the Victoria Geophysical Observatory. Studies of crustal deformation on Vancouver Island began at about that time, and the number of strong-motion accelerographs in Canada increased to forty-five, with twenty-six in western Canada. In 1976, the Pacific Geoscience Centre (PGC) was established, joining earth scientists with the Victoria Geophysical Observatory and the west coast marine geology unit of the Geological Survey of Canada.

The PGC was moved to its present site in Sidney, north of Victoria, in 1978.

Earthquake research is centered in the Geological Survey of Canada (GSC), with offices in Ottawa and at the PGC in Sidney. Coincidentally, Ottawa is also in a seismically active region, although southwest British Columbia is clearly the most seismically hazardous part of Canada. The GSC maintains the Canadian National Seismic Network with more than one hundred and twenty stations, including thirty three-component broadband stations. In the 1990s, the number of strong-motion accelerographs was increased to more than one hundred, with more than 60 operated by the GSC and fifty-eight by BC Hydro, which is, of course, particularly concerned with dam safety. In 1985, a new set of seismic hazard maps was incorporated into the National Building Code. The most recent set of hazard maps has been incorporated into the 2010 National Building Code.

The first leveling surveys for crustal deformation were carried out on Vancouver Island in 1929 and 1930 by the Geodetic Survey of Canada. These lines were resurveyed after the 1946 earthquake, showing evidence of subsidence of up to eighty millimeters, probably due to the earthquake. Other deformation studies used tide-gauge data and high-precision measurements of Earth's gravity. In 1991, a GPS station was set up as the first part of the Western Canada Deformation Array, now a network of nine stations in southwestern British Columbia. These geodetic studies

have been a major contributor to our understanding of the Cascadia Subduction Zone, and also led to the discovery of slow earthquakes on the Cascadia Subduction Zone, as discussed in Chapter 4.

Paleoseismic studies have lagged behind, principally because no active surface-rupturing fault has yet been found in British Columbia, in large part due to dense vegetation and heavy rainfall. However, the Canadians have studied their own marsh deposits on Vancouver Island that subsided during subduction-zone earthquakes. The contribution the Canadians have made to a better understanding of the Cascadia Subduction Zone and crustal deformation is very large, considering that it has been made by a relatively small number of research scientists. The key to the success of the Canadian research program is the application of multidisciplinary techniques by scientists of varied backgrounds, all located at the PGC in Sidney and at GSC headquarters in Ottawa.

The Canadian RADARSAT-2, launched in 2007, is one of the satellites providing radar interferometry data (Synthetic Aperture Radar), following RADARSAT-1, which was launched in 1995. It is operated for the Canadian Space Agency by MDA, which in 2014 produced a radar map of Canada.

Earthquake preparedness and response are the responsibility of the provinces; in British Columbia, this is the Provincial Emergency Program. The federal government will assist (when called upon) through the Office of Critical Protection and Emergency

Preparedness, the Canadian equivalent of FEMA. The Canadian counterpart of NSF is the Research Council of Canada. Active earthquake research is conducted at the University of British Columbia, Simon Fraser University, and Carleton University; all work closely with the GSC.

### **13. Getting the Word Out to the Public**

Scientists and engineers in the NEHRP program and in other federal agencies in the United States and Canada have made great advances in the understanding of earthquakes and of how to strengthen our society against future earthquakes. But how well has NEHRP and the Geological Survey of Canada succeeded in getting their research results out to society at large? Educating the public was one of the objectives of the original Earthquake Hazards Reduction Act of 1977, and this objective has been stated many times since, particularly at the prodding of Congress. Yet a quarter-century later, the public is still not well enough informed about earthquakes to demand action. Why?

Many government scientists and their supervisors believe their job is done when their research results are published in a government document such as a USGS Professional Paper. But the publications branch of USGS is underfunded and inefficient. Because the papers represent the official position of a federal

agency, they must be approved not only by other scientists but also by USGS and GSC management.

But most people don't have ready access to USGS and GSC publications, although instructions on how to obtain them are provided at the end of this book. Many USGS maps are available only online, which requires the user to have access to a large-format printer. To address the problem of ready access, the USGS has placed a list of all of its 110,000 publications from 1880 to the present on the World Wide Web, available at <http://usgs-georef.cos.com>. This list contains abstracts of some publications, and some of the more recent full publications are available online.

Even if you are successful in finding the list and purchasing a publication, you discover that it is written for other scientists and engineers, not for the general public. The papers are full of technical jargon, and a background in earthquake science is necessary to understand fully the results. Many USGS scientists, frustrated by bureaucratic delays in their own publications branch, publish their results in scientific journals. Non-USGS scientists, including myself, do the same. This fulfills the scientist's professional obligation but still does not inform the public, because the scientific journal articles are also full of technical terms.

The USGS, FEMA, GSC, and other agencies have responded by publishing circulars and fact sheets written in language easy for a nontechnical person to understand, and where available, these publications are listed in the lists of further reading suggestions at the

end of each chapter. In addition, USGS and GSC officials have testified in public hearings on policy issues, and they have made themselves available to civic groups and classes for presentations on their specialty. All USGS offices have a public information officer ready to respond to questions and to arrange talks to civic groups. I salute two USGS scientists who have taken it upon themselves to present earthquake information in user-friendly format: Sue Hough and Ross Stein. The Web pages of the USGS and other federal agencies have information that is useful and entertaining, geared to the general public. NOAA has slide sets of earthquake damage that are useful in instruction, and I have used them in my classes and in this book.

In general, though, the public is educated not by government documents, regardless of how well they are written, but by the broadcast and print media. A television reporter is interested in a breaking news story like an earthquake, not in public education. When a large earthquake strikes, my telephone rings off the hook for a day or a week, depending on how the story develops. Earthquake scientists, including myself, prefer to go about their lives unbothered by microphones or television cameras. During an earthquake, however, we get our fifteen minutes (or twenty-four hours) of fame, and any public education message has to be threaded into our response to the news story. That message often ends up on the cutting-room floor.

In 2014, I was interviewed by Associated Press after

the publication of a document pointing out the lack of resilience of Oregon communities against the next subduction-zone earthquake. In my view, the conclusions of this report were stark and frightening, particularly if we don't begin a major effort to strengthen our state, particularly the coast, against the inevitable earthquake we face. The young woman who interviewed me was not well informed about earthquakes, and, despite my efforts, the story that resulted was just another doomsday earthquake story, not implying new information about our lack of resilience. It was my job to tell this story in a convincing way, and I blew it.

In some cases, the media have an agenda in pursuing a story, as was the case after the 1906 San Francisco Earthquake, when newspaper articles downplayed the earthquake and emphasized the fire, twisting the statements of scientists in doing so. The 1994 Northridge Earthquake ruptured a blind fault that was previously unknown to the scientific community, and CNN developed a story that had as its theme the withholding by the oil industry of subsurface oil well and seismic data that could have revealed the presence of the earthquake fault. Several of us use oil-company data in our earthquake studies, so I was one of those interviewed by CNN and asked about how difficult it was for me to get information from oil companies. I told the interviewer in Atlanta that oil companies had supplied me with all the information I had asked for, even hiring as summer interns my students working



on earthquake projects. Nonetheless, the broadcast still carried the implication that oil companies had withheld data, and my comments stating the opposite were not used.

In the long run, the best way to get the word out is in the classroom, starting in elementary schools, where children are fascinated by earthquakes and volcanoes just as they are by dinosaurs. Earthquakes and volcanoes are generally included in courses in Earth science in high school, but these courses are not required and often are not even recommended in high school. Many high schools lack a teacher qualified or interested in teaching an Earth science course that would include a unit on earthquakes. I hope this book provides the resources to turn this problem around. The Great California Shake-Out has been adopted around the world, including the Pacific Northwest, and it holds promise because it involves so many people.

## 14. Summary and a Word about the Future

NEHRP, NASA's Earth Systems Enterprises, and NOAA's Tsunami Mitigation Program are mission-oriented, applied programs, not basic research programs. In the words of Sen. Barbara Mikulski (D., Maryland), this is *strategic* rather than *curiosity-driven* research. And yet

NEHRP has been responsible for fundamental discoveries not only about earthquakes but about how the earth deforms and behaves through time. Not only this, but NEHRP has brought about world leadership in earthquake science for the United States since its beginning in the 1970s. Most of what has been presented in this book is the result of research funded by the U.S. and Canadian federal governments. The U.S. earthquake program is the best in the world, even though it has not yet been able to weave an understanding of earthquake science and engineering into the fabric of society.

But U.S. leadership is now being challenged by the Japanese. The cost of the 1995 Kobe Earthquake was ten times the cost of the Northridge Earthquake the preceding year, and an additional cost was to the confidence of the Japanese in coping with the earthquake peril throughout most of their country. Accordingly, the Japanese government has ratcheted up its budget for earthquake hazards research to a much higher level than the American program, or that of any other country, possibly because so much of their country—including the capital city of Tokyo—is at great risk from earthquakes. The U.S. responded to the Northridge Earthquake with a one-year special appropriation with no long-range follow-up but instead an attempt by the Republican Congress in 1995 to dissolve the USGS, the principal agency responsible for earthquake research. If inflation is taken into account,

the funding for the earthquake program is lower in real dollars than it was in 1977, when NEHRP started.

Perhaps this is because earthquakes are still perceived as a California problem, despite the fact that earthquakes have caused great damage in Alaska, Hawaii, Idaho, Massachusetts, Missouri, Montana, Nevada, Oregon, South Carolina, Tennessee, and Washington, including the \$2 billion Nisqually Earthquake. Most people, if asked to list the things they would like the federal government to do, would not list earthquakes in the top ten, unless they live in an area that was recently struck by an earthquake, such as Olympia or Seattle. Because of this prevailing public attitude, leadership in earthquake studies may return to where it was at the beginning of the twentieth century, to Japan.

---

### *Suggestions for Further Reading*

Cassidy, J. F., G. C. Rogers, J. Adams, D. McCormick, and T. Onur. 2003. New opportunities for Canadian earthquake monitoring information and research. Geological Survey of Canada 2003-H3, available on GSC website.

Cassidy, J. F., G. C. Rogers, and R. D. Hyndman. 2003. The Pacific Geoscience Centre and one hundred years of seismological studies on Canada's west coast,

- in Jennings, P., H. Kanamori, and W. H. K. Lee, eds., *International Handbook of Earthquake and Engineering Seismology*, in press, CD-ROM.
- Crosson, R. S. 1972. Small earthquakes, structure, and tectonics of the Puget Sound region. *Bulletin of the Seismological Society of America*, v. 62, p. 1133-71.
- FEMA. 2001. HAZUS99, Estimated annualized earthquake losses for the United States. FEMA366, February 2001, available online from FEMA.
- FEMA Region X. 2002. Earthquake hazard mitigation handbook for public facilities, 99 p.
- Geschwind, C.-H. 2001. *California Earthquakes: Science, Risk, and the Politics of Hazard Mitigation, 1906-1977*. Baltimore: Johns Hopkins University Press. The story of the U.S. earthquake program from the 1906 San Francisco Earthquake to the establishment of NEHRP in 1977.
- Hanks, T. C. 1985. The National Earthquake Hazards Reduction Program—scientific status. *USGS Bulletin* 1659, 40 p.
- Ludwin, R. S., C. S. Weaver, and R. S. Crosson. 1991. Seismicity of Washington and Oregon: Geological Society of America Decade of North American Geology, Decade Map Volume 1, chapter 6, p. 77-98.
- Ludwin, R. S., A. I. Qamar, S. D. Malone, C. Jonientz-Trisler, R. S. Crosson, R. Benson, and S. C. Moran. 1994. Earthquake hypocenters in Washington and northern Oregon, 1987-1989, and operation of the Washington Regional Seismograph Network.

- Washington Division of Geology and Earth Resources  
Information Circular 89, 40 p.
- Milne, W. G., G. C. Rogers, R. P. Riddihough, G. A. McMechan, and R. D. Hyndman. 1978. Seismicity of western Canada. *Canadian Journal of Earth Sciences*, v. 15, p. 1170-93.
- National Earthquake Hazards Reduction Program. 2003. Expanding and using knowledge to reduce earthquake losses: Strategic plan 2001-2005. FEMA Document 383, 66 p. Available online from FEMA.
- Office of Technology Assessment, Congress of the United States. 1995. Reducing earthquake losses. Washington, D.C.: Government Printing Office, OTA-ETI-623, 162 p.
- Page, R. A., D. M. Boore, R. C. Bucknam, and W. R. Thatcher. 1992. Goals, opportunities, and priorities for the USGS Earthquake Hazard Reduction Program. USGS Circular 1079, 60 p.
- Plafker, G., and J. P. Galloway. 1989. Lessons learned from the Loma Prieta, California, Earthquake of October 17, 1989. USGS Circular 1045, 48 p.
- Scott, S., interviewer. 1999. Robert E. Wallace: Connections, the EERI Oral History Series.
- Earthquake Engineering Research Institute, OSH-6
- Stein, S., J. Tomasello, and A. Newman. 2003. Should Memphis build for California's earthquakes? *EOS Transactions of the American Geophysical Union*, , v. 84, p. 177, 184-85. Responses by A. D. Frankel and S. E. Hough in *EOS Transactions of the American Geophysical Union*, v. 84, p. 271-72.

USGS. 1996. USGS response to an urban earthquake:  
Northridge '94. USGS Open-File Report 96-263, 78 p.

# 14. The Role of State and Local Government

*“ . . . earthquakes, faults, the people who study them, and the social institutions that grapple with how to foil the natural terrorist beneath us.”*

Lisa B. Grant, University of California Irvine,  
in her review of *Living with Earthquakes in California*,  
in *Transactions of the American Geophysical Union*

## 1. Introduction

Although the president can declare a disaster without consulting the governor or local officials, the role of the federal government is largely advisory. It is the states and their counties, cities, and multi-city governments that must establish and carry out policy regarding earthquakes. The USGS can advise the governor about earthquakes, and NOAA can advise about tsunamis, but the final call must be from the governor and from local elected officials.

This chapter reviews the institutions that carry out

earthquake policies in the three west coast states and the province of British Columbia. We start with California, which has experienced more losses from earthquakes in the last century, and has dealt with them to a greater degree, than the other states or British Columbia. California is a pace-setter for fashion, music, and technology; and it is also a pace-setter in strengthening society against earthquakes.

## 2. California

In 1853, five years after the start of the Gold Rush, a state geological survey was organized, with a prominent physician and geologist, John B. Trask, as the first state geologist. Three years later, Trask, also a cofounder of the California Academy of Natural Sciences, began publishing compilations of earthquakes that had struck California. This was not to alert people to the hazard, but to show “that California quakes were no more severe or frequent than those felt on the East Coast.” Trask’s geological survey expired but was followed in 1860 by a second state geological survey headed by Josiah D. Whitney. Whitney visited the area most heavily damaged in the 1872 Owens Valley Earthquake—the first time an earthquake had been studied by a scientist employed by the state. But Whitney’s style was abrasive, and he was more interested in studying fossils whereas the legislature



wanted him to work on gold deposits. No one saw any value in studying earthquakes, so Whitney and his state geological survey were put out of business in 1874.

There was still interest in mining, though, and a state mining bureau was established in 1880, headed by a state mineralogist. This arrangement stayed in place until 1929, when the organization was renamed the Division of Mines and placed under the new Department of Natural Resources, under the supervision of the Mining Board. In that same year, the division hired its first geologist, whose assignment was to make a new geological map of the state. In 1961, the Division of Mines was renamed Division of Mines and Geology and placed under the Department of Conservation. Its head was named the state geologist, the first with that title since Whitney.

But the legislative charge to the division, like the USGS at the federal level, continued to be on mineral resources, although its geological staff had the expertise to work on environmental problems such as landslides and earthquakes. Things began to change in 1948, when Gordon B. Oakeshott was hired. Oakeshott and his family had been badly shaken by the Long Beach Earthquake of 1933, while he was completing his PhD studies on the San Fernando Valley and western San Gabriel Mountains. Oakeshott was captivated by earthquakes, and he carried this fascination to his new job with the state.

Oakeshott's chance came with the Kern County Earthquake of July 21, 1952, which he visited. At a

meeting at Caltech, the Division of Mines agreed to publish a report to be edited by Oakeshott containing all the major scientific contributions from universities and government agencies alike. After the publication of this report in 1955, Oakeshott took the lead in earthquake studies within the division, even though there was no clear authority from the legislature or the Mining Board for the division to do so.

In 1959, Ian Campbell, a widely respected professor of geology at Caltech, became the new chief of the division. By focusing on mining, the division had mainly served the rural counties of the state, but Campbell believed that it should serve the cities as well. Urban sprawl was eliminating valuable deposits of sand and gravel, and Campbell justified an urban geology program to the Mining Board by calling it an assessment of sand and gravel resources around major cities. In 1960, he started a mapping program in an area near Los Angeles where landslides had been destroying expensive homes. Following the 1964 Alaska Earthquake, Campbell received approval from the board to start an urban hazards mapping program, including earthquake shaking, and to begin studies of the San Andreas Fault.

The Mining Board was reconstituted as the State Mining and Geology Board, and new appointees included earthquake geologist Clarence Allen, engineering geologist Richard Jahns, and earthquake engineer Karl Steinbrugge—all supporters of earthquake research. The division has now returned to

its nineteenth-century name, the *California Geological Survey*.

A broad-based earthquake program was started with a budget of \$260,000 in 1969 (one-fifth of the division's total budget), increasing to more than \$400,000 the following year. The popular division publication, *Mineral Information Service* (renamed *California Geology* in 1971), began to publish articles on earthquakes that were easy for the general public to read. (This publication was discontinued in 2002 as a result of a budget crisis.) At the request of the California Disaster Office (later the Governor's Office of Emergency Services), the division published a map showing where earthquake damage could be expected. In 1970, an agreement was reached with the Division of Real Estate to review all proposals for subdividing land, about fourteen hundred per year. The Division of Mines and Geology recommended that, where appropriate, the Division of Real Estate should include a notice of possible earthquake hazard or other geologic hazard in its report to the public.

In 1969, following an earthquake-prediction scare in the Bay Area, State Senator Alfred Alquist of San Jose persuaded the legislature to appoint a Joint Committee on Seismic Safety, with himself as chairman. This legislative committee would be a driving force for earthquake legislation in the following decade. On February 9, 1971, the Sylmar Earthquake struck the San Fernando Valley, which Oakeshott had mapped as a PhD student. This earthquake produced unusually high

accelerations, leading structural engineers to request more information on the strong motion of earthquakes. In addition, a previously unrecognized reverse fault cut across housing developments, roads, and freeways, causing great damage. It became clear that the Field and Riley acts, which had been passed after the 1933 Long Beach Earthquake, were not adequate to regulate building construction. In addition, there was no requirement that active faults be taken into consideration in approving housing developments for construction.

Alquist's Joint Committee on Seismic Safety heard recommendations resulting from the 1971 earthquake, including one that the state establish a program to measure strong ground shaking during earthquakes. This program was assigned to the Division of Mines and Geology and paid for by an assessment of 0.0007 percent of the value of new construction as part of the cost of the building permit—all except for Los Angeles and San Francisco, which already had such an assessment. The bill creating the Strong Motion Instrumentation Program was signed into law by Governor Ronald Reagan in October 1971. In the first three years of this program, the Division received nearly \$1.25 million, an increase in its budget of about 25 percent.

Another law passed in 1971 was the requirement that cities and counties include a seismic safety element as one of the components of their general plan, adding earthquakes to other natural and urban hazards. This

was an outgrowth of a requirement put into place in 1937 and beefed up in 1955 that each city and county adopt a general plan to guide decisions regarding long-term development. The Division of Mines and Geology, along with other agencies, helped develop guidelines for preparing seismic safety elements and assisted several counties in preparing their plans, including emergency response plans, a plan for reducing hazards from old, unsafe buildings; and a map of local seismic hazards. However, most local agencies did not develop procedures for building permit review, which are necessary to implement the hazard-reduction policies of their general plans.

What about active faults, like the fault that had ruptured in the 1971 earthquake and damaged or destroyed buildings on top of it? Developers in the San Francisco Bay Area were building directly across faults that were known to be active. Geologist Clarence Allen of Caltech argued that the most likely place for a future fault rupture is where the fault has ruptured in the past. Evidence for past rupture could be determined by geological investigations.

Two months after the Sylmar Earthquake, Sen. Alquist, through the Joint Committee on Seismic Safety, introduced a bill to require the state geologist to identify zones centered on the San Andreas Fault and other well-defined active faults, calling for special measures before construction on these zones could take place. Assemblyman Paul Priolo of Los Angeles introduced a similar bill, but both bills died in

committee. The next year, both Alquist and Priolo revised their bills with advice from the Joint Committee on Seismic Safety and the Division of Mines and Geology. Compromise was necessary to get the support of local government lobbying groups, including adding an urban planner and a representative of county government to the State Mining and Geology Board. The final bill, renamed the Alquist-Priolo Geologic Hazard Zone Act, was signed into law by Governor Reagan in late 1972.

In the following year, guidelines for cities and counties were drawn up by the Mining and Geology Board defining an active fault under the new law. An Alquist-Priolo fault must have evidence of movement in the past eleven thousand years, the age of the Holocene Epoch following the Ice Ages. A geologic report on the presence of active faults was required prior to development in an Alquist-Priolo zone. The law established setbacks from the fault that would be off limits for construction. The setback could be widened or narrowed based on the recommendation of the geologist; a wider zone might be mandated based on a broader fault zone or on uncertainty in locating the fault. Another provision of the law was that a seller was required to inform a potential buyer that the property for sale lies in an Alquist-Priolo zone.

When the first fault maps appeared in late 1973, they were criticized because they “amount[ed] to libel of title to the lands inclosed” and “deprive[d] land owners of their property rights without due process of law.” In

response to this opposition, single-family homes not part of a subdivision (four or more lots) and buildings with up to three living units were excluded from the law, and the law was renamed the “Alquist-Priolo Special Studies Zone Act,” a less-threatening title than “Geologic Hazard Zone.” An Alquist-Priolo fault was required to be *well defined* by the Division of Mines and Geology. This neutralized enough of the opposition that fault zoning could continue.

The Alquist-Priolo Act has been amended eleven times and is now known as the Alquist-Priolo Earthquake Fault Zoning Act. The California Geological Survey (CGS) has issued 551 maps at a scale of 1 inch to 2,000 feet. On the basis of new evidence, 160 maps have been revised, and four have been withdrawn. Zone boundaries are set at five hundred feet away from most mapped faults but are as narrow as two hundred feet for less significant faults. For each fault that has been reviewed under the act, the CGS prepares a fault evaluation report documenting the reasons for zoning. CGS has completed 248 fault evaluation reports, which are available for public inspection. The geologic reports on proposed subdivisions required by the act must be accepted by the local jurisdiction, after which they are filed with the CGS where they, too, are available for public inspection. The fault-rupture hazard zones are described in detail by Hart and Bryant (1997), who also analyze the act’s success. See also the CGS website, [www.consrv.ca.gov/CGS/rghm/ap/ap\\_fer\\_cd/index.htm](http://www.consrv.ca.gov/CGS/rghm/ap/ap_fer_cd/index.htm).

What is the track record of Alquist-Priolo? The only major surface ruptures since the act went into effect accompanied the 1992 Landers Earthquake and 1999 Hector Mine Earthquake, both in thinly populated or unpopulated areas in the Mojave Desert. Some of the faults that ruptured had been zoned under Alquist-Priolo, and others had not. The act has not really been tested by a major earthquake with surface rupture in an urban area along an Alquist-Priolo Zone fault.

Alquist-Priolo has been criticized as attacking the wrong problem: in the 1971 earthquake, the damage from surface rupture was considerably less than damage from other causes, such as strong shaking or liquefaction. The next three urban earthquakes, 1987 Whittier Narrows, 1989 Loma Prieta, and 1994 Northridge, were not accompanied by surface rupture at all, yet damage from the last two earthquakes ran into the billions of dollars. But the Chi-Chi, Taiwan, Earthquake of September 21, 1999, on a reverse fault was accompanied by many miles of surface rupture in developed areas, and damage was nearly total along the fault rupture, with great loss of life, particularly in its hanging wall close to the fault (Fig. 12-15). The surface rupture was on a mapped fault. If Alquist-Priolo had been in effect in Taiwan when these areas were developed, great losses would have been prevented and many lives saved.

Should the Alquist-Priolo Act be exported to the Pacific Northwest? Many active faults have been mapped in Oregon (Figure 14-1) and Washington. In



western Oregon, where most of the people live, only the Portland Hills Fault would be considered for Alquist-Priolo zoning; it is well defined, and it is marked by a linear scarp at the base of the Portland Hills, but without clear evidence of Holocene displacement. LiDAR imagery has revealed surface ruptures in the Puget Sound region that would qualify for Alquist-Priolo zoning, but the Seattle Fault would not qualify because it is not well defined at the surface. Blind faults do not qualify for Alquist-Priolo zoning, even in California. And in southwestern British Columbia, no faults have been mapped that would be zoned under Alquist-Priolo.

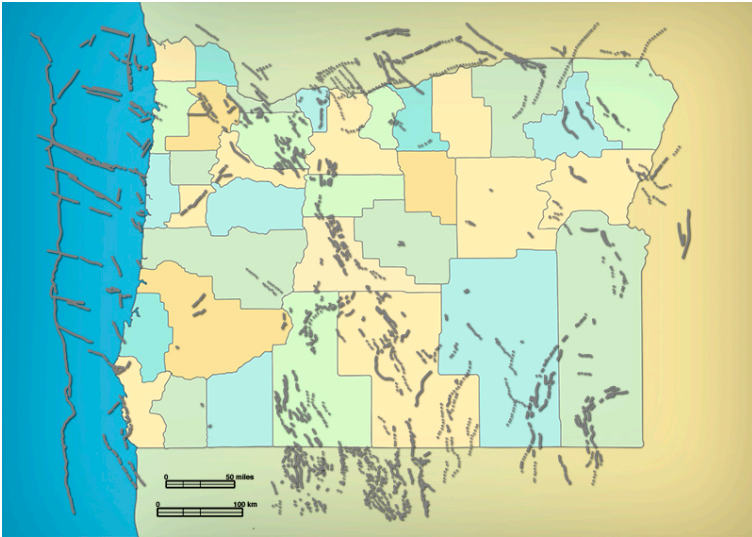

Figure 14-1. Map showing recent faults in Oregon, adjacent states, and the offshore region. Solid lines: faults with demonstrated movement in the past 20,000 years; irregular solid line at left margin marks Cascadia Subduction Zone. Dashed lines: faults with demonstrated movement in past 280,000 years. Dotted lines: faults with demonstrated movement in past 1,800,000 years. Faults shown as dashed or dotted lines could be active, but this has not been demonstrated on geological evidence. From Geomatrix Consultants (1995) and Oregon Department of Geology and Mineral Industries

The 1994 Northridge and 1989 Loma Prieta earthquakes in California demonstrated that much of the damage was to buildings in areas that underwent liquefaction and landsliding. As noted in Chapter 8, geological and geotechnical studies are able to identify building sites that are vulnerable to earthquake-related ground displacements. To address this hazard, the Seismic

Hazard Mapping Act was signed into law in 1990, which requires that not only active faults but earthquake-induced liquefaction and landsliding must be taken into consideration in planning and development decisions.

Maps have been prepared for much of the Los Angeles metropolitan area and for the cities of San Francisco and Oakland, with additional maps being prepared (see the California Geological Survey Web site at <http://www.consrv.ca.gov/>). The mapping program is supported by building permit fees supplemented by a grant from FEMA and the Office of Emergency Services. Cities and counties must use these maps to regulate development within areas identified as seismic hazards. Building permits must be withheld until the developer shows that the development plan will mitigate the hazard. The law is not retroactive, but if a property within a seismic hazard zone is sold, the seller must disclose that fact to the buyer.

However, the lack of any major urban earthquakes since the 1994 Northridge earthquake has led to a reduction of enforcement standards in the Los Angeles metropolitan area, although starting in 2014, the Mayor of Los Angeles, advised by Lucile Jones of USGS, is committed to stronger enforcement.

Similar maps have been prepared for urban areas in Oregon, Washington, and British Columbia, but their use is advisory only, not mandated by law.

Does this cover all hazards? What about faults or folds that are clearly active but are not well defined according to the Alquist-Priolo Act? For example,

geotechnical investigations connected with the planned Los Angeles subway revealed a warp on the south side of the Repetto Hills and Elysian Hills in East Los Angeles called the Coyote Pass Escarpment. This is not a well-defined fault, but it would clearly result in damage if it deformed during an earthquake. This hazard is covered under the Seismic Hazard Mapping Act. Response to faults that are not well defined departs from the Alquist-Priolo strategy of *mitigation by avoidance* (don't build on an earthquake fault) to *mitigation by design* (recognize the zone of deformation, then design structures that will survive surface deformation on it), which is the intent of the Seismic Hazard Mapping Act.

The actions taken by the state of California starting in the early 1970s were groundbreaking, even revolutionary. In no state in the United States and in no country in the world, including Japan, has the government taken such steps to mitigate earthquake hazards. Earthquake programs in all other states lagged behind the establishment of a national earthquake program, and for the most part they have been financed by federal grants. California, on the other hand, preceded the establishment of a national program by more than four years!

The *Governor's Office of Emergency Services (OES)* is the state's counterpart to FEMA, and federal disaster assistance is transmitted through OES. Like FEMA, the agency started out in civil defense in 1950, when the Soviets were ramping up their nuclear weapons

program, and Chinese troops were battling Americans in Korea. By 1956, the agency became more involved in natural disaster operations, and the name was changed from the State Office of Civil Defense to the California Disaster Office. The Emergency Services Act was passed in 1970, and the agency's name was changed to the Governor's Office of Emergency Services (OES). In 2008, the cabinet-level California Emergency Management Agency and the Office of Homeland Security were combined as part of OES.

The OES coordinates the response of state agencies to major disasters in support of local government. These disasters might be major wildfires, winter storms and floods, tsunamis, or earthquakes. They might be dam breaks, nuclear power plant emergencies, major spills of hazardous materials, and now, terrorist attacks. Communications vans and portable satellite units are available to be sent to disaster areas to ensure communications with remote areas as well as major cities where communications have been knocked out by an earthquake. One hundred and twenty fire engines are available at fire stations in strategic locations. A warning center is staffed twenty-four hours a day, and daily contact is maintained with the National Warning Center and offices of emergency services located in every county.

OES is responsible for the State Emergency Plan, California's equivalent to the Federal Response Plan. This plan contains the organizational structure of state response to natural and man-made disasters. OES helps

local governments and other state agencies in preparing their own emergency preparedness and response plans. A list of publications and videos is provided on the OES Web site at <http://www.oes.ca.gov/> The Earthquake Program of OES provides assistance to local and regional governments, businesses, hospitals, schools, human service agencies, community organizations, and individuals in earthquake preparedness. This program has coordinated, through the California Geological Survey, earthquake scenarios on the Cascadia Subduction Zone, the San Jacinto Fault in southeast California, and the Rodgers Creek Fault in the Bay Area, and the Great California ShakeOut response each October 15 to a M 7.8 earthquake on the southern San Andreas fault. The state's Earthquake Awareness Month is April, the month in which the 1906 San Francisco Earthquake struck.

The *Seismic Safety Commission* was established by the legislature in 1975 as a state agency to advise the governor, the legislature, and the public on ways to reduce earthquake risk. The commission manages the California Earthquake Hazard Reduction Program and reviews earthquake-related activities funded by the state. Fifteen of the seventeen commissioners are appointed by the governor, and the other two by the senate and assembly. In 1985, the California Earthquake Hazards Reduction Act charged the commission with preparing an Earthquake Loss Reduction Plan, most recently for 2007-2012, to reduce earthquake hazards

significantly. The commission proposes earthquake bills to the legislature and will oppose legislation that would weaken the state's earthquake safety program.

The commission issues reports on earthquake hazard reduction, including reports on building codes. Lists of publications are available at the commission's web site at <http://www.seismic.ca.gov> One of these publications is *The Homeowner's Guide to Earthquake Safety*. If your house was built before 1960, and you want to sell it, state law requires you to deliver a copy of the *Homeowner's Guide* to the buyer.

Humboldt and Del Norte counties are at risk from the Cascadia Subduction Zone, and activities in California have led to a greater resilience to the Cascadia Subduction Zone in California than in regions to the north.

### 3. Oregon

The *Oregon Office of Emergency Management (OEM)*, a division of the Oregon State Police, is the state counterpart to FEMA. OEM assists local governments in planning and education, including identification of hazards and technical advice. In addition to coordinating the state tsunami and earthquake programs, OEM manages disaster-recovery activities including public assistance and hazard mitigation grants. Grants were awarded for the retrofit of schools

after the 1993 Scotts Mills Earthquake. In 1972, the Oregon Emergency Response System was established by the governor, the first of its kind in the United States. It is managed by OEM as the primary point of contact for state notification of an emergency or disaster. Operations assigned to OEM include the statewide 9-1-1 emergency number, search and rescue, and a state emergency coordination center. This center is activated during a disaster to provide information, direction, and coordination during the disaster, and to provide liaison with the FEMA regional office in Bothell, Washington.

The governing legislation for OEM is ORS 401, which establishes rules for coordination with local government. Each county in Oregon is required to have an emergency operations plan, an emergency operations center, and an emergency program manager. Some counties also have a citizens' emergency management council, involving the community. Although not required, cities may also have an emergency management program, and three in Oregon do so. There is also an earthquake coordinator for Portland Metro, which includes Portland and satellite cities making up the Portland metropolitan area. The Emergency Coordination Center (ECC) is located at OEM headquarters in Salem and consists of twenty-two state agencies. When a disaster happens, the ECC is the primary contact with the governor and legislature as well as local jurisdictions.

In April 2003, OEM conducted a statewide training exercise called Quakex-2003, a simulated earthquake



and tsunami on the Cascadia Subduction Zone. The exercise involved more than one hundred federal, state, county, city, volunteer, and private industry organizations to enable them to test their individual emergency response plans. Those agencies participating were able to test the effectiveness of interagency coordination, cooperation, and communication during a large-scale simulated disaster. The destruction visited on each community was built into the scenario based on realistic assumptions of risk, to see how each agency would respond. Each jurisdiction tested an emergency operations plan, which outlined the roles and responsibilities of agencies and individuals during the emergency.

There were two distinct phases of Quakex-2003. The first phase (response) simulated the first forty-eight hours of the disaster. During this time, public utilities had to respond to repair outages, and local government responded to medical emergencies and threatening situations such as fire, dam failure, building collapses with people inside, flooding, tsunamis, hazardous waste spills, and coastal subsidence. Government began collecting information about the extent of the disaster, dispatching assistance as needed.

The second phase was a recovery phase one week after the disaster, with an emphasis on collecting initial damage assessments from local and state agencies. In a real disaster situation, this assessment would be used to advise the governor about declaring a state disaster area and to provide factual backup for a request to the

president to declare a national disaster area, thereby bringing in federal assistance. The assumption was made that Oregon would receive a presidential major disaster declaration, allowing federal and state agencies to work together, processing disaster assistance applications from individuals as well as businesses and local government. After the exercise, there was an after-action report to determine whether the objectives had been met.

OEM responds to a disaster if the city or county fails to act responsibly, if the disaster involves two or more counties, or if a major disaster is imminent or strikes a large area in the state. For Quakex-2003, it was obvious that a disaster would be declared, so everybody participated. The priorities are to save lives and protect public health and safety, provide basic life-support needs, and to protect emergency-response equipment, in that order. Of lower priority is the protection of public and private buildings. In a nutshell: lives first, buildings later.

Several presidential disaster declarations were issued for Oregon during the 1990s: three floods (1990, 1995, 1996), one windstorm (1995), the El Niño and drought of 1994 (which included a salmon-related economic disaster), and the two earthquakes in 1993. In the summer of 2015, disaster declarations have been issued against wildfires during the ongoing drought. Thus OEM is getting plenty of practice in real emergencies, preparing it for a future earthquake much larger than

the two that occurred in 1993, including planning for an earthquake on the Cascadia Subduction Zone.

Oregon requires each county to have an emergency management system to respond to a declaration of a state of emergency. Although all would agree that this is an important thing to have, it represents, at least in part, an unfunded mandate. It is an expression of the tendency of legislatures to pass worthy legislation (authorization) without providing the money to carry it out at the local level (appropriation). In 1997, a bill was introduced in Salem to allocate money to create a disaster reserve trust fund, to be administered by OEM, not to exceed \$30 million. Money would also be allocated to create and run the emergency management programs of the state and eligible jurisdictions to provide, among other things, statewide uniformity in an operation that requires close coordination for it to work in an emergency. Finally, money would be used as grants, to be awarded competitively to local jurisdictions or nonprofit organizations to implement hazard mitigation projects. Funds for this bill would come from the state lottery, from a tax on insurers against hazards including earthquakes, and from the general fund. With the financial restrictions facing the state legislature in 1997, this bill did not pass, and with the financial crises faced by the 2001 and 2003 legislatures, it is difficult to see how the state will have the resources to deal with the next disaster. It is an idea for the future.

OEM also provides administrative support for the

*Oregon Seismic Safety Policy Advisory Commission* (OSSPAC), established by Governor Neil Goldschmidt by executive order in 1990 after the Loma Prieta Earthquake, then confirmed by Senate Bill 96 in 1991. OSSPAC promotes earthquake awareness and preparedness through education, research, and legislation. OSSPAC includes five representatives from state government, one from local government, six from the public, and six from affected industries and stakeholders. OSSPAC supported several earthquake-related bills and six joint resolutions during the 2001 legislative session. During that session, the legislature passed three earthquake bills and two earthquake joint resolutions. One bill requires state and local agencies and other employers with two hundred fifty or more full-time employees to conduct earthquake drills. The other two bills require seismic safety surveys of schools, hospitals, and fire and police stations. The joint resolutions provide funds for the planning and implementation of seismic rehabilitation of public education and emergency service buildings. However, the legislature provided no funds for the surveys or rehabilitation, but instead sent the joint resolutions as ballot measures to Oregon voters. These ballot measures passed in 2002, authorizing the state to issue general obligation bonds for seismic rehabilitation of public education and emergency service buildings. However, as of September 2003, no funds have been authorized for either the surveys or retrofits, except for a bond issue passed for Portland Public Schools.

The Legislature authorized a resilience survey to be supervised by OSSPAC, which presented a grim future when Oregon is struck with the next subduction-zone earthquake. The survey presented a way forward if the State began a major retrofit of unsafe buildings and obsolete bridges, allowing ten years or more to strengthen the State against a major earthquake. A lot could be done in ten years. However, the Legislature failed to appropriate money to begin the project, and also did not pass a major transportation bill that would have addressed the problem of obsolete bridges, a problem the OSSPAC survey had highlighted.

The *Oregon Department of Geology and Mineral Industries (DOGAMI)* has undergone a dramatic shift in its mission in the past ten years. In earlier years, like the California Geological Survey, it focused on natural resources and the regulation of their extraction, including sand and gravel, groundwater, minerals, and fuels. Geologic hazards were also considered to some extent in reports issued by the agency.

With the recognition of an earthquake hazard in the late 1980s, the legislature in 1989 passed Senate Bill 955, which directed DOGAMI to improve the state's understanding of earthquakes and other geologic hazards and to use this knowledge to reduce the loss of life and property due to these hazards. DOGAMI's responsibilities are established by several statutes, starting with ORS 516 with administrative rules, in which the agency is the state repository of information about geologic hazards, including earthquakes.

DOGAMI conducts research programs in coordination with the federal government, other state agencies, local government, and universities, usually with federal grants rather than state funding. It is the lead agency in coordinating the issuance of permits for facilities for metal mining and chemical leach mining. It also archives all site-specific seismic reports for critical and essential facilities in Oregon. However, its funds are limited.

DOGAMI has produced earthquake hazard maps of the Portland, Salem, and Eugene metropolitan areas, in which these areas are divided into zones of increasing earthquake hazard based on ground shaking, liquefaction, and potential for landsliding. Plans are underway to construct similar maps for other cities. One use of these maps is to superimpose a building inventory on the earthquake zones, as the State of California and the Portland Bureau of Buildings have done. This highlights the unreinforced masonry buildings that lie in the highest earthquake hazard zone and assists in establishing retrofit priorities. These maps are suitable for the application of the Uniform Building Code to regulate construction on ground subjected to these earthquake hazards.

Senate Bill 379, passed by the Oregon legislature in 1995 and implemented as ORS 455.446 and 455.447, restricts the construction of critical facilities and special-occupancy structures in tsunami flooding zones. In response, George Priest of DOGAMI, in cooperation with scientists outside the agency,

constructed tsunami runup maps for the entire Oregon coast. These maps take into consideration the range of sizes of the next earthquake on the Cascadia Subduction Zone as well as a detailed understanding of the configuration of the sea floor, which focuses tsunami waves as they approach the coast. In addition, DOGAMI has done a detailed tsunami study of the Siletz Bay area of Lincoln City and is engaged in detailed studies at Newport and Seaside. A tsunami inundation map of Newport, prepared by DOGAMI, NOAA, and the Oregon Graduate Institute of Science and Technology, is shown as Fig. 9-15a.

Other duties of the agency include serving as the lead technical agency in the Oregon Emergency Response Plan, the installation of strong-motion accelerographs in new buildings, the review of plans for dams and power plants, and participation in the Oregon Seismic Safety Policy Advisory Commission. OSSPAC coordinated an earthquake resilience plan for Oregon, as charged by the legislature.

Assignment of responsibilities to DOGAMI has not always been accompanied by sufficient state funds to do the job. The National Earthquake Hazards Reduction Program, through its focus on the Puget Sound-Portland metropolitan area, provided grants for research in earthquake hazards to DOGAMI, and this was supplemented by individual grants to scientists within DOGAMI and in universities. FEMA and NOAA have also been sources of money. Federal funds made it possible to hire an earthquake geologist, Ian Madin,

who served as a highly visible point man for informing the public about earthquake hazards in Oregon. Madin is now DOGAMI Chief Scientist. More recently, the state has allocated funds to DOGAMI to carry out its earthquake-related mission, although, as stated above in another context, appropriation still lags behind authorization.

## 4. Washington

The Washington counterpart of FEMA and coordinator of the Washington Earthquake Program is the *Emergency Management Division (EMD)*, part of the Washington Military Department. A *Seismic Safety Committee*, part of the Emergency Management Council, reviews state earthquake strategies, with the most recent update in February 2002, after the Nisqually Earthquake. The EMD collaborates with FEMA in offering courses to the public and private sector on using the HAZUS loss estimation modeling software. EMD also developed an All Hazard Planning Guide for Washington schools. Since the earthquake, the Hazard Mitigation Grant Program provided several grants for seismic retrofit of three water districts, two schools, and a fire department. In addition, the Department of Transportation conducted a retrofit of highway bridges that significantly reduced lifeline losses as a result of the Nisqually Earthquake. As in California, April is



Disaster Preparedness Month, with the theme in 2003 “Prepare Because You Care,” featuring a statewide “Drop, Cover, and Hold” earthquake drill with more than a million citizens participating. Washington also participates in the ShakeOut exercise on October 15 of each year.

The *Division of Geology and Earth Resources (DGER)*, part of the Department of Natural Resources, was formed to evaluate mineral resources, like similar agencies in Oregon and California. Like those states, DGER has become more involved in evaluating hazards from earthquakes, landslides, and floods. Steve Palmer of DGER led a program to map urban areas subject to liquefaction and lateral spreading. As described elsewhere, these maps were tested by the Nisqually Earthquake. Palmer and his colleagues Wendy Gerstel and Tim Walsh were able to predict fairly well those areas that underwent liquefaction and lateral spreading in both Seattle and Olympia (Fig. 8-16). Liquefaction susceptibility maps are in preparation for other cities in western Washington. In addition, DGER has a grant from the Hazard Mitigation Grant Program to produce a state map showing liquefaction susceptibility and soil characteristics.

In 1990, Washington passed its Growth Management Act to require comprehensive planning in its most rapidly growing counties and cities. This act required these cities and counties to designate and protect critical areas subject to geological hazards, including landsliding and earthquakes. In 1991, the act was

broadened to require the designation of critical areas in all Washington's cities and counties. The dampening effect this law has had on rapid development around metropolitan areas has led to attempts to amend it in the legislature, and even to repeal it outright.

Unlike California, where the state was proactive in upgrading building codes and grading ordinances, Washington has left much of this to local jurisdictions. For example, there is no state requirement that school districts implement programs to improve the earthquake safety of school buildings. Rural counties and small cities in western Washington, including school districts, have lagged behind the metropolitan centers of Puget Sound, especially Seattle, which has standards that are comparable to those in metropolitan areas of California. Because the Seattle-Olympia area had experienced damaging earthquakes in 1949, 1965, and 2001, school buildings had already been reinforced against earthquakes to a greater extent than in Oregon to the south.

Nearly half of the total damage to Washington schools in the 1949 earthquake was in Seattle; twenty-one schools had to be replaced or repaired. Additional damage to schools was sustained in the 1965 earthquake. Following the 1965 earthquake, the Seattle Public School District began to evaluate its schools for seismic risk, and by 1998, the district was in the final phase of implementing \$40 million in capital improvements addressing earthquake hazards. In 1988, the Superintendent of Public Instruction issued a

manual, *Mitigation of School Earthquake Hazards*, that was updated in 1998. Funds from FEMA's Project Impact were used to remove overhead hazards, especially overhead flush tanks in rest rooms that would pose a danger if they collapsed into a classroom on a lower floor. In addition, funds were used to train maintenance staff to work on nonstructural hazards; these teams are supported by volunteers. At the time of the Nisqually Earthquake, seven schools had been retrofitted by volunteers during Saturday work parties; no injuries or damage was reported at any of these schools during the earthquake.

FEMA designated the city of Seattle as a Project Impact community with an initial grant of \$1 million to develop its own earthquake and landslide hazard mitigation program. At the outset, Seattle had 125,000 old houses built prior to requirements that they be bolted to their foundations, with an additional 125,000 houses in King County, outside the city limits. Project Impact has resulted in a program of educating citizens in retrofitting their residences, businesses, and schools and in developing emergency plans. The Seattle Emergency Management office, part of the police department, provides home repair kits, conducts repair workshops, and maintains an approved list of contractors who have the skills to do earthquake retrofits. A special program is in place for businesses. The role of volunteers is critical; the Seattle Disaster Aid and Response Teams (SDART) educate neighborhoods in organizing themselves against a

disaster (see Chapter 15). In addition, hazardous areas in the city are being mapped by the USGS and scientists from the University of Washington to identify those areas where special precautions need to be taken in development. Seattle has exported this information to eighteen surrounding cities and counties.

The city of Bellevue is not a Project Impact community, but it has been proactive in earthquake preparedness just as Seattle has. The city's emergency preparedness division is part of the fire department. Retrofitting of homes is encouraged through speeding up the permit process and helping homeowners obtain low-interest loans for retrofitting. The city has an All Hazards Emergency Plan, responding to severe weather as well as to earthquakes. A project called Strengthening Preparedness Among Neighbors (SPAN) develops emergency plans in neighborhoods, electing team captains and meeting four times a year to review preparedness plans. In alternate years, the city conducts a seven-hour full-scale drill.

DGER and EMD have a tsunami mitigation program for those coastal areas of southwest Washington that are at risk from tsunamis. Inundation maps from a tsunami generated by a subduction-zone earthquake have been prepared. In cooperation with NOAA's TIME program, tsunami modeling is underway for a tsunami generated by an earthquake on the Seattle Fault, and DGER has published a map with those results. The tsunami potential of the Seattle waterfront has also been evaluated. Maps of Neah Bay, Quileute River, Port

Orchard, Port Townsend, and Port Angeles are on the DGER Web page; maps of Bellingham, Anacortes, and Whidbey Island are in preparation. In 2003, the city of Long Beach and the Quinault Nation were recognized as Tsunami Ready and Storm Ready communities. The Quinault Nation was the first Native American nation to receive this award.

## 5. British Columbia

The *Provincial Emergency Program (PEP)* is the responsibility of the attorney general of British Columbia. An Earthquake Preparedness Section has been organized within this program; this includes a multidisciplinary *Seismic Safety Committee*. As of 2003, a resource pool drawn from several Provincial ministries makes up the Temporary Emergency Assignment Management System (TEAMS), which manages the government's response to any hazard, including earthquakes. PEP has developed curriculum learning resources for elementary and secondary schools.

In November 1996, British Columbia held its third earthquake response exercise in its Thunderbird Series in the Greater Victoria area, responding to an imaginary M 6.9 earthquake fifteen miles from downtown Victoria. The main purpose was to train Provincial response coordinators, with a secondary goal of

evaluating a local community college as a coordinating and communications center in the event of an earthquake. More recently, the province conducted a tsunami hazard warning and alerting exercise based on a series of waves affecting the entire B.C. coastline. The exercise was followed by public education and awareness workshops in each coastal community. The adjacent Province of Alberta is collaborating with British Columbia in preparing for an earthquake, recognizing that when the subduction-zone generates an earthquake, Alberta will be part of the response.

The British Columbia Geological Survey has focused on hazard maps of the city of Victoria and of New Westminster and Chilliwack on the mainland. These maps are as detailed as any on the west coast and are suitable for microzonation and land use planning. The Victoria maps may be accessed at [www.em.gov.bc.ca/mining/geolsurv/surficial/hazards/default/htm](http://www.em.gov.bc.ca/mining/geolsurv/surficial/hazards/default/htm)

## 6. Building Codes

One of the most important steps that can be taken by a community in defending itself against earthquakes is upgrading its building codes. Most codes are written such that a structure built under a seismic code should resist a minor earthquake without damage and resist severe earthquakes without collapse of the building. Building codes place life safety over property damage.

They establish minimum standards based on average soil conditions. As discussed in Chapter 8, local ground conditions could generate seismic ground motions that exceed those in the code provisions.

Regulations to reduce property damage and loss of life were in existence in America prior to the American Revolution, when the main concern was the spread of fire in densely populated New York City. Comprehensive building regulations were introduced in the mid-nineteenth century, and in 1905, the National Board of Fire Underwriters published a model building regulation aimed at fire damage. Because of the cover-up of the role of earthquake damage in the 1906 San Francisco Earthquake, nothing was done at that time about extending building regulations to protect against earthquakes.

As structural engineers began to recognize that buildings could be constructed to resist earthquakes, the situation began to change. Following the destructive Santa Barbara Earthquake of 1925, Santa Barbara and Palo Alto passed ordinances upgrading their building codes to take earthquakes into account. But it took the much more destructive Long Beach Earthquake of 1933 to produce statewide action, including an upgrade of building codes. The legislature passed the Field Act upgrading school construction standards and the Riley Act covering other buildings. Earthquake resistance was added to building codes in Los Angeles County and City, Long Beach, Santa Monica, Beverly Hills, and Pasadena, essentially putting

an end to the use of unreinforced brick construction in California. Later, earthquake-resistance standards were applied to bridges, hospitals, and dams. Subsequent upgrades to the building codes, generally triggered by large earthquakes such as the 1971 Sylmar, 1989 Loma Prieta, and 1994 Northridge earthquakes, have produced the highest earthquake-resistant building standards in the United States.

The starting point for building codes is the Uniform Building Code (UBC), published by the International Conference of Building Officials with its headquarters in Whittier, California. The UBC was developed following local ordinances in California in the 1920s and 1930s. In the Pacific Northwest, local governments began to base their code upgrades on the UBC, starting with the City of Seattle in 1946. The code established seismic zones in which earthquake reinforcing was recommended, but the Pacific Northwest, except locally, was placed in Seismic Zone 1, requiring no reinforcement against earthquakes.

In 1952, following the 1949 Puget Sound Earthquake, the Puget Sound region was placed in Seismic Zone 3; the rest of Washington and the Portland area were placed in Zone 2. In the following year, Seattle and Tacoma adopted sections of the 1952 UBC, although Tacoma deleted the requirement that houses be bolted to their foundations. Further upgrades in Washington followed the 1965 Seattle Earthquake and the 1971 Sylmar, California, Earthquake. Action at the state level took place in 1974, when Oregon adopted the Structural



Specialty Code and adopted the 1973 UBC, placing itself in Zone 2, and in 1975, when Washington adopted the 1973 UBC and established a Building Codes Council. Further upgrades followed the recognition that western Oregon and Washington are at risk from a subduction-zone earthquake, including upgrading most of the urbanized parts of Washington and Oregon into Seismic Zone 3 and placing part of the Oregon coast in Seismic Zone 4. The Washington legislature adopted the latest UBC in 2003.

The increase in construction standards is illustrated for Oregon in Figure 14-2; the Washington increase is similar. If your house was built before the mid-1970s, there was no requirement that it be bolted to the foundation; in many areas, this requirement was not enforced until the early 1980s.

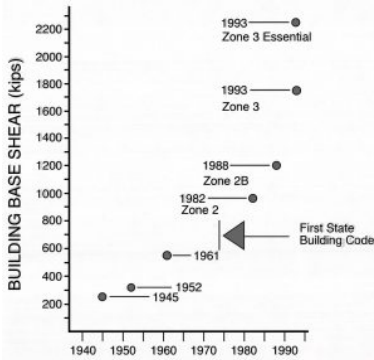

Figure 14-2. Change in building codes in Oregon since 1945 for a typical mid-rise building with respect to seismic base shear force (horizontal) measured in kips (1 kip = 1,000 pounds per square inch). With this diagram and the age of the building, it can be determined how much shear resistance was allowable in the building when it was constructed. From Grant Davis, KPFF Consulting Engineers, courtesy of Franz Rad, Portland State University

The United States now has two model building codes. The most widely used is the International Building Code (IBC), developed by the International Code Council, consisting of the three original model code organizations, the Building Officials and Code Administrators International, the Southern Building Code Congress International, and the Council of American Building Officials. The second was developed by the National Fire Protection Association and is called

NFPA 5000; it has been adopted by California. The IBC, upgraded every three years, has as its objective “to provide minimum standards to safeguard life or limb, health, property, and public welfare while regulating and controlling design and construction.” Priority is given to protecting the inhabitants of a building over the prevention of damage to the building itself. Building codes represent minimum standards; the owner may

well choose to have higher standards than those required by the code.

Two cautions should be made about building codes. The first tradeoff is cost. Upgrading seismic resistance can add up to five percent of the cost of a new building, and for retrofitting, the percentage increase is higher. For a new building, the revised codes set the standard, and the owner must decide whether or not to exceed these standards to get better building performance in an earthquake—a decision similar to whether to obtain earthquake insurance. For a retrofit, the decision is harder, because of the added cost to a business, or the added cost to taxpayers if a public building is retrofitted. Without better insight into earthquake forecasting than is now available, the owner's decision is a gamble. The estimation of average annual losses due to earthquakes for each county in the United States using HAZUS can be compared with the annual construction cost of upgrading the building code.

The second caution is that upgrading the building code does not automatically make the area safe against earthquakes. New buildings will meet the standard, as will major remodels of buildings. But old buildings that are not remodeled will continue in the building inventory, and when these are unreinforced masonry (URM) or nonductile concrete, they are potential time bombs. The greatest loss of life in the 1971 Sylmar Earthquake was in those buildings on the campus of the Veterans Administration Hospital that had not been

retrofitted after the 1933 Long Beach Earthquake (Figure 12-1).

In 1988, California established the URM Law requiring local jurisdictions to inventory their URM buildings, establish loss-reduction programs, and report periodically to the state. As of early 2003, 13,303 buildings have been retrofitted and 3,458 demolished at a cost of \$3 billion. Almost nine thousand URM buildings remain in use, but this program is clearly working. Because of these retrofits, the northern California part of the subduction zone is clearly the best prepared for a subduction-zone earthquake.

Oregon and Washington have numerous school buildings, city halls, public-housing projects, retirement homes, churches, dams, and bridges that have not been upgraded. The 1993 Scotts Mills (Spring Break) Earthquake caused bricks to fall off Molalla High School that would have caused injury or death to students if school had been in session (Figure 14-3). The Klamath County



*Figure 14-3. Damage to Molalla High School, an unreinforced-masonry (URM) building, from the Scotts Mills Earthquake of 1993. Bricks from the URM gable over the doorway fell on the steps and sidewalk. Fortunately, the earthquake occurred early in the morning, and no students were in the building. Photo courtesy of Yumei Wang, Oregon Department of Geology and Mineral Industries*

courthouse was damaged in 1993, and the Grays Harbor courthouse was damaged in the 1999 Satsop Earthquake. The Oregon capitol was damaged in 1993, and the Washington capitol in 2001. However, significant efforts are underway in both states to retrofit schools and bridges. Despite the existence of seismic building codes since the mid-1970s in Washington and Oregon, there are still buildings constructed under earlier building codes that do not meet modern standards and are subject to collapse. It's important to know the year of construction (or last retrofit) of the building where you work or live so that you can compare it with Figure 14-2.

Following the 1993 seismic upgrade of building codes, the Oregon legislature, through Senate Bill 1057, established a Seismic Rehabilitation Task Force in 1995 to provide recommendations about how to eliminate those structures that are earthquake hazards. At the same time, the City of Portland, through its Bureau of Buildings, established its own task force to consider the seismic strengthening of existing buildings. Senator Peter Courtney strongly advocated for funds to seismically retrofit the State Capital building, but the Legislature failed to authorize the money.

The state task force recommended that all unreinforced masonry (URM) buildings be rehabilitated within seventy years, with the more dangerous within thirty years, following a statewide inventory of buildings by the year 2004 to be conducted by the Building Codes Division. Mandatory strengthening

would be required for appendages outside a building such as parapets and signs that could fall on people below during an earthquake. Essential and hazardous URM buildings would be repaired by the year 2019. Essential buildings would include fire and police stations and emergency communications centers. Hazardous facilities would include structures housing hazardous or toxic materials that could be released during an earthquake. A program for rehabilitating hospitals was also proposed.

Other buildings would be rehabilitated based on passive triggers: actions within the control of the owner that would require the building to be strengthened. These triggers would include (1) changes in use that would increase the risk to occupants, (2) renovations that are substantial relative to the value of the building, and (3) renovations or additions that could potentially weaken the existing structure. To encourage and facilitate the strengthening of buildings, a state tax credit was proposed that would be equal to 35 percent of the investment for seismic rehabilitation retroactive to the year western Oregon was upgraded to Seismic Zone 3, and a local property tax abatement equal to 35 percent of the seismic rehabilitation cost were proposed. Implementation of the program would be assigned to the Department of Geology and Mineral Industries (DOGAMI). These recommendations were incorporated into House Bill 2139, introduced in the 1997 legislative session. However, this bill failed to pass. The plan is presented here in the event that a future

legislature in Oregon or Washington might adopt it when state finances improve.

Although the state did not act except for critical facilities, the city of Portland is upgrading its URM building inventory through its Dangerous Building Code. Based on an ordinance passed in 1995, two hundred URM buildings have been retrofitted, most due to a change in building use or the installation of a new roof.

An opinion survey was conducted among four hundred Portland residents. When asked to rank earthquakes among several social and environmental concerns, earthquakes were ranked relatively high, behind crime and violence, cancer, motor vehicle accidents, and fire. However, none of the categories was listed as “high risk.” Respondents were also asked to rank on a scale of 1 to 10 (1 = no money should be spent to strengthen the facility, 10 = it is absolutely essential to strengthen the facility) their priority ratings for strengthening key buildings and infrastructure facilities. Hospitals, buildings for storing hazardous wastes, emergency communications buildings, bridges and overpasses, and schools received ratings above 8.

The insurance industry, through its Insurance Services Office, has established a system to grade the 454 building code enforcement departments in California on the effectiveness of their building codes, considering the quality of inspection and plan review as well as construction standards. The results of the grading will appear in an insurance publication called

the Public Protection Classification Manual, which is read by more than a hundred thousand insurance agents and actuaries. A high grade should lead to discounts on insurance premiums for new construction, similar to discounts based on fire insurance grading systems.

The problem, as stated elsewhere, is that building retrofits do not necessarily increase the ability of the building to generate additional income, and furthermore, the scientists cannot tell them how soon their buildings will be struck by a major earthquake. Should the building owner bear the total cost of upgrading, or should the cost be borne, at least in part, by local government?

## **7. Grading Ordinances and Regulation of Building Sites**

Building codes deal with the safety of buildings, but how about the site on which the building is constructed? A good example of a poor building site is the Leaning Tower of Pisa. The tower itself is in good shape, but the soils beneath the building are unable to hold it up, and it has settled differentially, causing it to lean.

A perfectly sound building is unsafe if it's built on a landslide, on a sea cliff subject to wave erosion, on



soils subject to liquefaction, or on an active fault. As part of its public safety obligation, a city or county may take responsibility for evaluation of the safety of a building site, just as it takes responsibility for the structural integrity of a building. Ordinances passed for this purpose are called *grading ordinances*. Grading, which is one of the first steps in virtually any building project, can include excavation by a bulldozer or backhoe or it might involve placement of fill material to provide a flat surface for building. In either case, the natural landscape is altered, and regulation is required to ensure that the alteration of the landscape will not harm residents of other sites—particularly those downhill, in addition to the potential residents or workers in buildings on the site in question.

Grading ordinances call into question the fundamental right of individuals to do with their land whatever they want. This differs from building codes, which might require a better-engineered and better-designed structure to be built for safety reasons but would not prevent some sort of structure from being built on a site. It's difficult for a landowner to accept the fact that the property might contain hidden geological fatal flaws such as active faults or landslides that could prevent it from being developed at all. A site with a beautiful view over a steep hillslope should not be developed if the steep hillslope providing the view is the scarp of an active fault or a landslide. The site could become unstable because of the actions of the builder or owner, such as heavy use of irrigation sprinklers.

In 1952, the City of Los Angeles adopted the first grading ordinance in the United States and set up a grading section within the Department of Building and Safety. The city was growing out of the lowlands and up into the surrounding hills, and building sites there were found to be subject to major landslides, with extensive property losses.

The grading ordinance was upgraded in 1963 to require both engineering and geologic reports to be submitted, and to require that grading operations be supervised by both a soils engineer and an engineering geologist. Although responsibilities overlap, the soils engineer or geotechnical engineer deals directly with the strength and bearing capacity of earth materials on which a structure is to be built and on the tendency of a hillslope to slide, and an engineering geologist takes more account of the past geologic history of a building site, including old landslides, evidence of faulting, and the inclination of bedding and fracturing of rock formations on site. Geotechnical engineers and geologists must be licensed to practice in all three west coast states.

The standard reference for grading was Chapter 70 of the Uniform Building Code (UBC), written in the form of an ordinance that can be modified to fit the situation in the city or county where it is adopted. In the 1997 edition of the Code, the Grading Code appears in Chapter A-33. In the 2010 edition, soil and grading information is contained in chapters 18 and 18a. Other jurisdictions may have different chapters for grading.

The local building official decides which sites pose a potential threat to life and public safety, requiring an evaluation of the site and supervision of grading. For commercial developments, Chapter A-33 provides for reports by both geotechnical and geological consultants employed by the developer and a review of the findings by soils engineers and geologists employed by the city or county for that purpose. The cost of a plan review, like the cost of a building inspection, is borne by the developer in the form of permit fees. A plan reviewer might ask questions such as: Is provision for drainage off the property adequate so that other property owners are not affected? Are cut slopes gentle enough that they would not be expected to fail by landsliding? Is the bearing strength of the soil sufficient to hold up the building? Do potentially active faults cross the property? This last is covered by Chapter 16 of the Code, which also contains sample regulations that cover geotechnical tests for liquefaction and ground shaking.

California passed an addition to its Health and Safety Code requiring that all cities and counties adopt the UBC Grading Code or its equivalent. Unfortunately, many cities and counties lack the professional expertise to regulate grading effectively. In addition, implementation of the Grading Code in some communities has been opposed by developers and building contractors as well as a few politically well-connected landowners. However, where the Grading Code has been used, including review by consultants

for the city or county, losses related to geologic conditions have dropped by 90 to 95 percent. The law works!

Accompanying the increase in standards for grading is an increase in the number of lawsuits. If a development is approved, but a landslide subsequently destroys homes on the property, the landowner, the contractor, the engineering and geological firm, the city or county approving the plans, even the bank lending the money for the development may be sued. Were any of the parties negligent in approving the development? As the standards of practice are raised, so, then, are the conditions under which someone could be found negligent.

Oregon and Washington are far behind California in establishing grading ordinances. The ones that exist are largely in the metropolitan areas of Portland and Seattle. Some cities require engineering and geologic reports subject to city review, more do not. This may change after the floods of February and December 1996, when many homes, including some worth hundreds of thousands of dollars, were destroyed by active landslides. According to Scott Burns of Portland State University, the Portland, Oregon, metropolitan area suffered more than seven hundred landslides, resulting in seventeen houses being red-tagged (meaning that they would have to be demolished) and sixty-four houses yellow-tagged (meaning that the occupants could not return until certain repairs had been made). In most cases, these landslides could have

been identified by a geologist prior to the development. This led to a flurry of lawsuits, including some against cities and counties. The plaintiff, who may have lost his million-dollar home to a landslide, argues that the city should have known that the site was unsafe, since establishing that fact is standard practice in other parts of the country. Many cities are (or should be) watching these lawsuits with interest and perhaps trepidation.

The Oso landslide in Snohomish County in western Washington on March 22, 2014 was not caused by an earthquake. The area had been studied by a geologist with the USGS who identified the potential for landsliding. Nonetheless, the County did not require geotechnical or geological work to be done on the site prior to construction of homes. The landslide took 43 lives and was widely publicized nationally. Lawsuits resulting from this landslide may force local governments in the Northwest to adopt legally enforceable grading ordinances.

A problem faced in the Northwest is the difference between what can be done—“*state of the art*”—and what is the *standard level of practice* in the area. Clearly the standard level of practice is much higher in the Los Angeles and San Francisco metropolitan regions than it is for most of Oregon or Washington, although the “*state of the art*” is the same in all those areas. For example, it is quite straightforward to evaluate a building site for liquefaction and ground-shaking potential, and Chapter 16 of the Uniform Building Code presents sample ordinances to do this. But it is not

standard practice for most of the Pacific Northwest, and it is not carried out, despite the existence of maps of metropolitan Seattle, Portland, Salem, and Victoria that point to areas of potential hazard from liquefaction, ground shaking, and earthquake-induced landsliding, and the success of maps of Olympia and parts of Seattle showing liquefaction and lateral-spread potential in predicting those areas that actually underwent damage in the 2001 Nisqually Earthquake.

Jim Slosson, an engineering-geology consultant and former state geologist of California, is the source of what has come to be called Slosson's Law, a corollary to Parkinson's Law: "The quality of professional work will sink to the lowest level that government will accept." This applies to building codes as well as grading ordinances.

California requires property owners or their agents to disclose to prospective buyers the fact that a property is in a seismic hazard zone or an Alquist-Priolo fault zone. Effective March 1, 1998, an amendment requires disclosure when one of two conditions is met: (1) the seller has actual knowledge that the property is within a seismic hazard zone; or (2) a map that includes the property has been provided to city and county officials by the state geologist, and a notice has been posted at the offices of the county recorder, county assessor, and county planning agency. Disclosure laws are much weaker in Oregon and Washington.

## 8. Other State Agencies

The California State Department of Insurance licenses and regulates insurance companies and manages a privately financed earthquake insurance plan, the California Earthquake Authority. This plan is discussed in detail in Chapter 10. Caltrans has the responsibility of maintaining the state's highways and bridges, and it funds research in earthquake engineering, particularly the earthquake resistance of bridges and overpasses. The Washington and Oregon Departments of Transportation have similar responsibilities to Caltrans in maintaining the highway network and in bringing bridges and overpasses up to modern codes.

## 9. Universities

Until the 1960s, most earthquake research was done at the universities, including the establishment of seismograph networks at the University of Washington, University of California at Berkeley, University of Nevada, and Caltech, in contrast to Canada, where seismography was always a responsibility of the federal government. As noted above, seismographs were considered to be an academic pursuit at the University of Washington until the advent of federal funding for seismographs to monitor nuclear weapons testing. At

the present time, networks in the Northwest, Great Basin, and northern California are supported by the federal government, even though they are administered by universities. If an earthquake strikes the Pacific Northwest, the Pacific Northwest Seismograph Network at the University of Washington is called. Both University of Washington and USGS scientists work in the same building, and the distinction between federal and university research is not always clear.

With the recognition of the seismic threat to the Northwest, the University of Washington, Oregon State University, and Portland State University have added faculty with expertise in earthquake geology and earthquake engineering. The University of Oregon and Central Washington University have also developed capabilities in earthquake geology and tectonic geodesy; and geodesists are also at the University of Washington and Oregon State University. As a result, both states have a reservoir of experts able to advise government and the public on earthquake issues, although they do so as private individuals rather than representatives of their respective institutions.

## 10. Regional Organizations

The Western States Seismic Policy Council (WSSPC) is a partnership of emergency managers and state geoscience organizations working on earthquake



hazard mitigation, earthquake preparedness, emergency response, and recovery. It includes all the five western states, British Columbia, Yukon, and Pacific island territories. Federal agencies that are part of WSSPC include the Department of Transportation, FEMA, NOAA, and USGS.

WSSPC is very much involved in training and technology transfer—in getting the message out to the public. It holds an annual conference, collects publications on earthquake matters produced by its member organizations, and helps find money to work on earthquake research. Its web site is [www.wsspc.org](http://www.wsspc.org)

Another working group in the Pacific Northwest, including northern California, is the Cascadia Region Earthquake Workgroup (CREW), focused on mitigation against a Cascadia Subduction Zone earthquake. CREW includes representatives from FEMA; state emergency services agencies; the scientific community represented by USGS, universities, and state geological surveys; and private industry. Its executive director, Heidi Kandathil ([hkandathil@crew.org](mailto:hkandathil@crew.org)), Bob Freitag, is housed at the University of Washington. The involvement of the private sector might be the most important hallmark of CREW. In addition to the expected concerns about loss of life and property, industries in the shadow of the Cascadia Subduction Zone are concerned about loss of market share in the event of a catastrophic earthquake. An example of the loss of market share is provided by the Port of Kobe, Japan, which became inoperable after the 1995 Kobe

Earthquake. As a result, other ports in Japan took over the business that had previously gone to Kobe, and the Port of Kobe has yet to regain its pre-earthquake level of business. CREW has a video directed toward businesses in the Northwest. Another group is the Redwood Coast Earthquake Study Group, concentrating on earthquake hazards on the northern California coast.

The Oregon Natural Hazards Workgroup (ONHW) is part of the Community Service Center at the University of Oregon in Eugene, which provides planning, policy, and technical assistance to communities throughout Oregon. Under the leadership of its founding director, André LeDuc, ONHW helps communities develop disaster mitigation programs at both the state and local levels. This includes training and helping communities find additional funding and technical resources to prepare themselves better for disasters, including earthquakes. The role of the ONHW is to link the skills, expertise, and innovation of higher education with the risk-reduction needs of communities and the state, thereby providing service to Oregon and learning opportunities for students. ONHW assisted Clackamas County in preparing its FEMA Disaster Mitigation Plan, the first in the country to be completed under a new law enacted in 2000. ONHW can be contacted at [onhw@uoregon.edu](mailto:onhw@uoregon.edu), and their website is <http://darkwing.uoregon.edu/~onhw>. LeDuc is now executive director of Enterprise Risk Services.

A nonprofit corporation called Consortium of

Organizations for Strong-Motion Observation Systems (COSMOS) has been formed to encourage improvement in strong-motion measurements and applications, especially in urbanized areas, and to promote the wide dissemination of strong-motion instrument records after an earthquake. The organization is an outgrowth of discussions among the California Strong Motion Instrumentation Program of the California Geological Survey, the USGS, the Bureau of Reclamation, and the Corps of Engineers. COSMOS has its headquarters at the Pacific Earthquake Engineering Research (PEER) center of the University of California Berkeley, located at Richmond. PEER is an NSF-funded research center for earthquake engineering focusing on West Coast problems.

This list of organizations changes over time, and the interested reader should start with the descriptions above and identify the present organizations.

## II. A Final Word

The people of California, spurred by disastrous earthquakes in 1933, 1971, 1989, and 1994, have enacted the strongest earthquake laws in the United States, and, indeed, in the world. If a fault is active, you can't build on it. If an area has a tendency to slide during earthquakes, you'll have to do a lot of remedial engineering to place a building on it. And if you're

selling a property next to an active fault or within an area with the potential for liquefaction or earthquake-triggered landsliding, you'll have to tell the buyer about the problem. If you don't and there's a damaging earthquake, you can expect a lawsuit.

This is revolutionary land-use legislation. It goes against the so-called inalienable right of a person to do whatever he or she can get away with on his or her own land, because to do otherwise diminishes the value of the land. It states that the value is based not only on a spectacular view but also on hidden flaws that the nonspecialist might not be able to recognize, but are just as apparent to a geologist as a brain tumor is to a cancer specialist. Californians have accepted this infringement on their property rights—albeit grudgingly. California is a pace-setter. If it's popular in California today, then it'll be popular everywhere else tomorrow. Is this true for California's earthquake laws as well?

Oregon has upgraded its building codes close to California standards, but its land-use laws are essentially unchanged. On paper, the seller is required to tell a buyer about geological flaws on the property, but loopholes in the law make this requirement unenforceable. The state has made maps of Portland, Salem, and Eugene showing areas of potential liquefaction and landsliding, but no laws require a developer to abide by these maps. The earthquake problem in Oregon is a federal problem; except for tsunamis, the state has provided no money for

earthquake hazard reduction, either from building permit fees or the general fund.

Washington, too, upgraded its building codes, most recently in 2003, and its Growth Management Act provides a way to monitor development on unsafe land. Aside from this act, there is no state regulation of land development, and so this responsibility has been taken up by the cities, most notably Seattle. Its regulation of land development is comparable to that in California, and it has advocated similar controls in other cities, aided by Project Impact funds from FEMA.

Despite these laws, many houses still rest on active faults or are perched atop beach cliffs that someday will slide into the sea, or sit on soft ground that will liquefy during an earthquake. But the life span of many houses is mercifully short, and if we have patience, or luck, these structures will cycle out of the building inventory in a few generations and be replaced by homes that are bolted to their foundations with reinforced cripple walls. If state law is not degraded by future land capitalists, houses built on the Portland Hills Fault won't be followed by new houses in the same precarious places. So in seventy or eighty years, if present state laws are allowed to remain in place, the old, unsafe buildings will be replaced, which should make for "earthquake-resistant communities," to borrow a phrase from FEMA's Project Impact.

The problem is enforcement. The decisions that count are not made at the federal level nor even in state legislatures, which set the standards but do not carry

them out. These decisions are made by city councils asked to approve a land development, or planning commissions considering a zoning variance, or building inspectors checking out the welds on steel-frame buildings. Just as the “state of practice” drops precipitously at the California state line, so also does it drop away from the cities around the Bay Area, metropolitan Los Angeles, Seattle, and Portland. Geologists from state agencies have fanned out to explain the new land-use laws to local governing bodies, only to find that many of them have never heard of the planning maps or don’t know how to use them. The decisions that count are too often driven by a well-connected land developer rather than advice from a distant state capitol.

Furthermore, pressure to weaken land-use laws will occur if there is a long period without headline-grabbing earthquakes. The landmark Field Act, upgrading school construction standards after the Long Beach Earthquake of 1933, came under immense pressure after World War II, when the remembrance of collapsed school buildings was overwhelmed by the surging postwar economy. The Seismic Safety Commission and its counterparts in Oregon, Washington, and British Columbia are watchdogs for such legislation at the state level, but what about zoning decisions in a faraway county or city that has yet to experience a disastrous earthquake?

My hope as I write this book is that new laws and building codes are becoming so woven into the fabric

of West Coast states that attempts by developers to weaken them will be resisted—not only by scientists, engineers, and planners who are earthquake professionals, but by informed citizens who have the courage to hold their local elected officials to their responsibilities. Earthquakes are an environmental problem just as surely as logging old-growth forests, heap-leach mining in the back country, environmental pollution from nuclear wastes at Hanford, or spoiling a beautiful stretch of coastline or a pristine mountain valley by housing developments. Let's hope we live up to the challenge.

---

### *Suggestions for Further Reading*

California Division of Mines and Geology and State Mining and Geology Board. 1997. Guidelines for evaluating and mitigating seismic hazards in California. California Division of Mines and Geology Special Publication 117. 74p.

Cascadia Regional Earthquake Workgroup (CREW). 2003. Business survival kit for earthquakes and other disasters: 27-minute video for small- to medium-size businesses including disaster planning toolkit. Available from Michael Lienau, Global Net Productions, [www.globalnetproductions.com](http://www.globalnetproductions.com) or [www.crew.org](http://www.crew.org).

- Cascadia Regional Earthquake Workgroup, 2013, Cascadia Subduction Zone Earthquakes: A magnitude 9 earthquake scenario, 2013, 23p.
- Geschwind, C.-H. 2001. California Earthquakes: Science, Risk, and the Politics of Hazard Mitigation, 1906-1977. Baltimore: Johns Hopkins University Press. The growth of the California earthquake program since the San Francisco Earthquake of 1906.
- International Conference of Building Officials, updated every three years. Uniform Building Code in three volumes, available in hard copy or CD-ROM. Whittier, CA: ICBO, Web page [www.icbo.org](http://www.icbo.org)
- Mileti, D. S. 1999. Disasters by Design: A Reassessment of Natural Hazards in the United States. Washington D.C.: National Academy Press. 351p.
- Oregon Seismic Safety Policy Advisory Commission (OSSPAC), 2013, The Oregon Resilience Plan: Reducing Risk and Improving Recovery for the Next Cascadia Earthquake and Tsunami: [http://www.oregon.gov/OMD/OEM/osspace/docs/Oregon\\_Resilience\\_Plan\\_Final.pdf](http://www.oregon.gov/OMD/OEM/osspace/docs/Oregon_Resilience_Plan_Final.pdf). summary 8 p.
- Scullin, C. M. Excavation and grading code administration, inspection, and enforcement. Available through ICBO, Whittier, CA, Web page [www.icbo.org](http://www.icbo.org)
- Smith, T. C., and B. McKamey. 2000. Summary of outreach activities for California's Seismic Hazards Mapping Program 1996-1998. California Division of Mines and Geology Special Publication 121. 38p. and appendices.



Washington State Seismic Safety Committee, Emergency Management Council, 2012, Resilient Washington State, a framework for minimizing loss and improving statewide recovery after an earthquake: Final report and recommendations: Division of Geology and earth Resources, Information Circular 114, 38 p.

# 15. Preparing for the Next Earthquake

*“In its relation to man, an earthquake is a cause. In its relation to the Earth, it is chiefly an incidental effect of an incidental effect.”*

K. Gilbert, 1912,  
preface to U.S. Geological Survey Professional  
Paper 69

## I. Introduction

We are in denial about earthquakes. During the past fifteen years, scientists have reached a consensus that great earthquakes have struck the Pacific Northwest, and more will arrive in the near future. Government has responded by upgrading construction standards and establishing an infrastructure of emergency services down to the county level. Media reports take it as a given that there will be future damaging earthquakes.

Yet if the average person were to list the top ten concerns in his or her daily life, earthquakes probably would not make the list, not even in California.

In terms of public perception, earthquakes might not

be all that different from other disasters such as floods or wildfires. Television reports show expensive homes burned out by forest fires, or homes flooded out in the Willamette Valley, but since people own the land on which their former homes stood, they tend to rebuild in the same place, if local government will let them. In new suburbs of Seattle and Portland, some are opposed to laws restricting building next to an active fault or landslide. Nobody seems to learn anything.

There's the story about sheep grazing at the edge of a field. A wolf comes out of the forest, grabs a sheep, and carries it off. The other sheep scatter and bleat for a few minutes, then continue their grazing. The forest is still there, and the wolf will come back, but the sheep graze on.

So it is with earthquakes. The Scotts Mills Earthquake struck in 1993, a flurry of excitement followed, and newspaper editorials referred to the earthquake as a wake-up call (see the *Oregonian* by Jack Ohman cartoon at the beginning of the book). A person living in Vancouver, Everett, or Eugene—cities not struck by a damaging earthquake during the time people have been keeping records—simply doesn't believe earthquakes are a problem. Local elected officials don't believe it either. The Nisqually Earthquake was a major story in early 2001, but no great urban earthquake has struck since then, and Oregon got off scot free. Earthquakes have dropped out of the news, and most people have forgotten about them.

It is in light of such public apathy that this chapter

is written. You try to organize your household, your neighborhood, and your children's schools, but your efforts might result in your being called Chicken Little, warning that the sky is falling. If you're serious, you must be determined and patient and have a thick skin. It won't be easy.

## 2. Getting Your Home Ready

Chapter 11 focused on steps you can take to make your home and its contents more resistant to earthquake damage. This chapter presents ways you can prepare yourself and members of your family to survive an earthquake and to help others survive as well. It's analogous to the fire drills in school or aboard an oceangoing ship. We're pretty sure our school or the ship will not catch fire, but we conduct the fire drills all the same. Fire drills are built into our culture. Earthquake drills are conducted in most schools, but they are often not taken seriously—even by the school officials who conduct them

What can happen to your house in an earthquake? Shaking could cause a chimney to collapse, plate-glass windows to break, tall pieces of furniture to fall over, or a garage to cave in. Liquefaction or landsliding beneath your foundation could cause your house to move downslope, breaking up as it does so, and snapping underground utility lines. This happened in the Marina

District of San Francisco in 1989 and in parts of the San Fernando Valley in 1994. A severe winter storm might result in dozens of landslides, but a large earthquake might result in thousands, some more than a mile across. If you live on the coast, your house might be in danger of a tsunami, in which case you have only a few minutes to get to high ground, above the tsunami run-up line.

Some steps outlined here are not unique to earthquakes. Many are the same steps you would take to survive a terrorist attack. They would apply if you were marooned by a flood or a landslide that cut off access to your house. But a large earthquake like Northridge or Loma Prieta differs in the large number of people impacted. The 9-1-1 emergency number would be overwhelmed and essentially useless, as it was in the earliest stages of the Nisqually Earthquake. You could lose your phone service, electric power, water, sewer, and gas for days or weeks. Police and ambulance services would be diverted to the most serious problems such as collapsed apartment buildings or major fires. Access to your house or from your house to the nearest hospital could be cut off by a damaged bridge or a major landslide.

For these reasons, be prepared to survive without assistance or any public utilities (gas, water, sewer, electric power, or phone service) for up to three days. If you are at work, or your children are at school when the earthquake strikes, you need to have a plan in place outlining what each member of the family should do.

Designate a contact person outside the potential disaster area that everyone should contact if your family is separated.

Prepare an inventory of your household possessions and keep it away from your house, in a safe deposit box or with your contact person outside your area. This inventory will come in handy when you submit your insurance claim (Chapter 10).

### 3. Earthquake Preparedness Kit

Designate a kitchen cabinet or part of a hall closet in your house as the location of an earthquake preparedness kit. Everyone should know where it is and what's in it. Make it easy to reach in a damaged house. (The crawl space in your basement is not good, especially if you haven't reinforced your cripple wall.) The kitchen is okay, and so is an unused and cleaned-out garbage can in your garage—unless the garage is prone to collapse due to “soft-story” problems. Many items listed below are handy in any emergency—not just an earthquake. (Maybe you are already doing this as your part of the war on terrorism.)

- *First-aid kit*, fully equipped, including an instruction manual. Check expiration dates of medicines and replace when necessary. Liquids and glass bottles should be sealed in zip-loc

storage bags. Keep your previous prescription glasses here; your prescription might have changed, but the glasses will do in an emergency.

- *Flashlights*, one per person, preferably with alkaline batteries. Replace batteries every year, following a schedule. Keep extra batteries in the package they came in until ready for use. Several large candles for each room, together with matches. Coleman lantern, with an extra can of gas for it.
- *Portable radio* with spare batteries. If the power is off, this will be your only source of information about what's going on. Your portable phone won't work if your phone service is cut off. Your cell phone might work, but heavy phone traffic could make it hard to get through, as was the case during the Nisqually Earthquake, the first "cell-phone earthquake." It may be more difficult to call locally than to call long distance.
- *Food*, in large part what you would take on a camping trip. Granola bars, unsalted nuts, trail mix, and lots of canned goods (fish, fruit, juice, chili, beef stew, beans, spaghetti). Dried fruit, peanut butter, honey (in plastic containers, not glass), powdered or canned milk. We're talking about survival, not gourmet dining, but try to stock with food your family likes. Keep a manual can opener and other cooking and eating utensils separate from those you use every day. If you lose power, eat the food in your freezer first. It will

keep for several days if the freezer door is kept shut as much as possible.

- *Fire extinguishers.* Keep one in the bedroom, one in the kitchen, and one in the garage. Attach them firmly to wall studs so they don't shake off. Keep a bucket of sand near your fireplace during the winter, when the fireplace is in frequent use.
- *Drinking water.* You'll need one gallon per person per day for at least three days; more is better. Large plastic containers can be filled with water and stored; change the water once a year. Two-and-one-half-gallon containers are available, but one-gallon containers are easier to carry. Your water heater and toilet tank are water sources, but if the water heater is not strapped and falls over, its glass lining may break, requiring the water to be filtered through a cloth. Empty the water heater by turning off the heater (remove its fuse or shut off its circuit breaker) and its hot-water source, then turn on a hot water faucet and fill containers. Water purification will be necessary. Do not use toilet tank water if the water has been chemically treated to keep the bowl clean (turns blue after flushing). Swimming pool or hot tub water is okay for washing but not for drinking. Turn off your house water supply at the street to keep sewage from backing up into your water system. Plug bathtub and sink drains. If you're a backpacker or you travel in underdeveloped countries, you already know about hand-operated water pumps,



filters, and purifying tablets, available at outdoor stores like REI. Iodine purifying tablets make the water taste terrible, but you can add other tablets to neutralize the taste. Store these with your preparedness kit, and use them if there is any doubt about the water, including water from the water heater or toilet tank. You can also use liquid bleach in a plastic container, but do not use granular bleach!

- **Tools.** Keep a hammer, axe, screwdriver, pliers, crowbar, shovel, and Swiss Army knife in your kit, along with work gloves and duct tape. Buy a special wrench to turn off the gas at the source. Keep this at the gas valve, and make sure everyone knows where it is and how to use it. If you smell gas, turn your gas supply off immediately (Figure 11-7); the pilot light on your furnace would be enough to catch your house on fire. Don't turn it on again yourself—let a professional do it. Keep a wrench at the water meter to shut off your water at the source. If your water is shut off, you won't be able to use the bathroom. Use your shovel to dig a hole in your yard for a temporary latrine. Line the hole with a large plastic garbage bag; alternatively, sprinkle with lime after each use (purchase the lime from a hardware store). If you are able to get to your bathroom, you could line the toilet with a small garbage bag, use the toilet, and dispose of the bag.
- **Camping gear.** Keep in one place tents, sleeping

bags, tarps, mattresses, ponchos, Coleman stoves and lanterns, and gas to supply them so they are as accessible as your preparedness kit. Picnic plates and cups, plastic spoons, paper napkins, and paper towels should be in your kit.

- *Other items.* Large, zip-loc plastic bags; large and intermediate-size garbage bags with twist ties; toothbrushes and toothpaste; soap; shampoo; face cloths; towels; dish pan and pot; toilet paper; sanitary napkins; shaving items (your electric razor won't work); baby needs; and special medications (especially for elderly people).
- *Kits for elsewhere.* Under your bed, keep a day pack with a flashlight, shoes, work gloves, glasses, car and house keys, and clothes for an emergency. Keep another day pack, along with a fire extinguisher, in the trunk of your car and—if you work in an isolated area—at your workplace.

## 4. Other Preparations

After a major earthquake, civil authorities will inspect your neighborhood to see whether damage has occurred, and they might determine that your house is dangerous to live in. This is due to fear that the structure might collapse with you inside. If your house is labeled with a *red tag*, you will not be permitted to live in it, and the house will have to be torn down.

If your house is labeled with a *yellow tag*, you will be ordered to leave and will not be allowed to return until the necessary repairs are made, and your house is determined to be safe to live in. Accordingly, you should have ready those items you need if you are forced to leave your home for an extended period of time.

It's nice to have a first-aid kit, but make sure that you and your family know how to use it. Take a first-aid course and a CPR class (there are lots of reasons to do this, not just earthquake preparedness). You might be called on to help your neighbor, and access to a hospital may be blocked.

## 5. Neighborhood Plan

Many neighborhoods already have a “neighborhood watch” plan for security. Arrange a meeting once a year to discuss contingency plans in case of an earthquake. Are some of your neighbors handicapped or elderly? Are there small children? Do some of your neighbors have special skills? There are advantages to having a plumber, carpenter, nurse, or doctor for a neighbor. Do each of you know where your neighbors' gas shut-off valves are located? Be prepared to pool your resources. You can make lifelong friends during a major calamity. Your county or city emergency services coordinator, police department, and Red Cross office will be glad to help you get organized.

The Humboldt County, California, Office of Emergency Services (707-268-2500) has information on forming a Neighborhood Emergency Service Team (NEST) in your neighborhood. These groups of neighbors, members of local organizations, and employees of local businesses, headed by an elected NEST captain, are organized against any disaster—not just an earthquake. Seattle’s Community Emergency Response Team (CERT) has established more than three hundred and sixty neighborhood teams serving twenty-five thousand city residents. The city of Bellevue has similar neighborhood organizations with team captains; these meet several times per year.

## **6. Your Child’s School and Other Buildings You Use**

Damaged school buildings were the impetus for the first California law upgrading building standards—the Field Act of 1933. Oregon and Washington waited until after the general building code upgrade of the mid-1970s. Since then, major school retrofit programs have begun in Seattle, Portland, Eugene, and Corvallis, generally funded by bond issues and addressing other needs besides earthquakes, such as antiquated furnace systems. There are still many communities where these

measures have not been started; bond issues to upgrade schools continue to fail.

Your school can take steps that cost little or no money, only time. Work through the PTA to ensure that the school has its own earthquake-preparedness supplies, an evacuation plan, and earthquake drills. School officials may not take earthquake drills seriously. Ask questions about the specifics of staff training and responsibilities. What is the school's plan to release children (or to house them in the school building) after an earthquake? Are hazardous materials stored properly? Are there heavy bookcases that might topple on children at their desks (Figure 11-10) or light fixtures that might come down on top of them (Figure 12-7)? The Seattle Public Schools, through Project Impact, implemented a program to remove overhead hazards, install automatic gas shutoff valves, and organize site teams to improve classroom safety, including teachers, support staff, parents, and volunteers. These improvements greatly limited property damage in the 2001 Nisqually Earthquake.

Earthquakes seem to pick on universities. The 1989 Loma Prieta Earthquake caused more than \$160 million in damage to Stanford University, including the building housing the Department of Geology. The university had previously been damaged severely by the 1906 San Francisco Earthquake; at that time it was a relatively new campus. The 1994 Northridge Earthquake trashed California State University at Northridge—again including the Department of Geology, which was still in

temporary quarters two years later. The University of California at Berkeley is crossed by the Hayward Fault and is at risk from a M 7 earthquake in the near future. Seismic retrofit programs have been underway since 1978, with the expenditure of \$250 million, but more than one-fourth of usable campus space is labeled “poor” or “very poor” in terms of earthquake resistance. Retrofitting these unsafe buildings over a period of twenty to thirty years will cost at least \$1.2 billion. The University of Washington campus is built on glacial till overlying thick sedimentary deposits of the Seattle Basin, possibly amplifying earthquake waves from a subduction-zone earthquake or an earthquake on the Seattle Fault. Portland State University is close to the active Portland Hills Fault.

Let’s pray that the earthquake doesn’t strike on a Sunday morning. The Nisqually Earthquake shook loose two of four spires towering over the First Baptist Church on Capitol Hill in Seattle; one of these spires weighed nine thousand pounds. Many cities have large church buildings constructed of unreinforced masonry. In most cases, the churches do not have earthquake insurance, nor do they have the money to bring their buildings up to code.

And how about those historic courthouses, built of unreinforced masonry in the nineteenth century? Lovely to look at, but dangerous to work in. The Klamath County, Oregon, courthouse was rendered useless after an earthquake of M 6 in 1993, and the Grays Harbor, Washington, courthouse was severely

damaged during the 1999 Satsop Earthquake. On the other hand, if the building is a structure of historical significance, funds might be made available to repair it.

## 7. During the Earthquake

The strong shaking *will* stop. For a M 6 to M 7 earthquake, strong shaking will last less than a minute—in most cases less than thirty seconds—but it might seem the longest minute of your life. A subduction-zone earthquake can produce strong shaking of one to four minutes, but it, too, will stop.

The earthquake mantra is *duck, cover, and hold on*. Duck under something such as a table or desk, and *cover* your face and neck with your arms. *Hold on* until the shaking stops. Teach this to your children, and make it part of your own family earthquake drill.

The greatest danger is something collapsing on you. So get under a big desk or table. Stay away from windows, chimneys, or tall pieces of furniture such as a refrigerator or china



Fig. 15-1. During an earthquake, drop, cover, and hold on. Under a heavy table is good, but don't stand in a doorway, which might collapse from horizontal stresses.

cabinet. Standing in a doorway is not a good option, unless you happen to live in an adobe house in a third-world country. The doorway might be in a wall that isn't braced against shear, and both wall and doorway could collapse, sandwiching you in between. Do not run outside, because you might be hit by debris or glass falling from the building.

If you can't get under something, sit or lie down with your feet and hands against a wall. Turn away from glass windows or mirrors. Don't hold or pick up your dog or cat; it will be so confused that it might bite you. Stay where you are until the strong shaking stops. If a vase is about to topple from a table, don't try to catch it.

Should you be at a stadium or theater, cover your head with your coat and stay where you are. Do not rush to the exits. The behavior of the California crowd when the Loma Prieta Earthquake struck at the beginning of the World Series game in October 1989 was exemplary. There was no panic, and people did not trample over others trying to get out of the ball park. There were no injuries. The important thing to remember is that there is no reason to leave. After the shaking stops, there will be plenty of time to head for the exits.

At work, get away from tall, heavy furniture (Figure 11-10) or get under your desk. The fire sprinklers might come on. Stand against an inside wall. If you're in a tall building, do not try to use the elevator; it probably won't work. If the lights go out, just stay where you are.

If you're in a wheelchair, lock your wheels and stay



where you are. If you're out in the open, move only if you're close to a building where debris could fall on you.

Should you be outside in a business district with tall buildings, get as far away as you can from the buildings, where plate glass could shatter and masonry parapets could come crashing down on you. Stay away from tall trees. Watch for downed power lines.

If you're in your vehicle (with seat belt fastened), pull over to the side of the road. Do not stop under an overpass or on a bridge. Watch for places where sections of roadway might have dropped. Clarence Wayne Dean, a California Highway Patrol officer on his way to work on his motorcycle, was killed when he drove off the end of a freeway overpass that had collapsed from the Northridge Earthquake. If wires fall on your car, stay in your car, roll up the windows, and wait for someone to help you. You might be waiting a long time, but the alternative—electrocution—makes the wait a safer if more boring choice.

## 8. After the Earthquake

Look for fires in your own home and the homes of your neighbors. Look out for downed power lines. Has anyone been injured? Is your house damaged enough to require it to be evacuated? Consider your chimney as a threat to your life until you have assured yourself that it's undamaged. Check for gas leaks, and if you smell

gas, turn off the main gas valve to your house (Fig. 11-7), which will extinguish all your pilot lights.

In case of a fire, try to put it out with your fire extinguisher or your bucket of sand. The most likely place for a fire is your wood stove if it has turned over. You have a few minutes to put the fire out. If the fire gets away from you, get everybody out of the house.

An earthquake might cause electric and telephone lines to snap. Even if you have no power, do not touch any downed power lines.

This is not the time to get in your car and try to drive around town looking at the damage. Roads will be clogged, making life tough for emergency vehicles. Stay where you are and turn on your portable radio. You'll be given status reports and told what to do and what not to do. If you're told to evacuate your neighborhood, do so. You will be told where to go. Do not decide on your own that you can tough it out where you are. Lock your house, unless it's too damaged to do so, to protect against looters.

## 9. Aftershocks or a Foreshock?

Crustal earthquakes and subduction-zone earthquakes have many aftershocks, and they will cause a lot of alarm. In a large earthquake, aftershocks will continue for months and even years after the main event. Many of these will be felt, and some can cause damage to

already weakened buildings. This is one of the reasons you might be asked to leave your house. Though still standing after the main earthquake, it could be so weakened that it might not survive a large aftershock. Warn your family members that there will be aftershocks.

However, there is always the possibility that the earthquake you just experienced is a foreshock to an even larger one. The great 1857 Earthquake on the San Andreas Fault of M 7.9 was preceded by a foreshock of about M 6 at Parkfield. The Denali Earthquake of M 7.9 in central Alaska on November 3, 2002, was preceded eleven days earlier by a foreshock of M 6.7. The Chinese have based their successful earthquake predictions on foreshocks—in some cases many foreshocks. Normal-fault earthquakes, occurring in crustal regions that are being extended or pulled apart, such as the Basin and Range of Nevada, southeast Oregon, and eastern California, are more likely to have foreshocks.

## 10. Special Problems with Tsunamis

If you live on the coast, you will have the same problems everybody else has with shaking and unstable ground. But you'll have an additional problem: the threat of inundation from a large wave from the ocean.

In the case of a distant tsunami, such as the one that originated in Alaska and struck Port Alberni, B.C.,

Seaside, Oregon, and Crescent City, California, in 1964, a warning will be issued by the Tsunami Warning Center in Alaska, including an expected arrival time of the tsunami. You will have time to evacuate to high ground. It's critical that you have a portable radio turned on to listen for tsunami warning updates. Most of the people who got into trouble in the Easter weekend tsunami of 1964 were just enjoying a normal spring holiday, without enough concern for events in the rest of the world to keep up with the news. With satellite communication and tsunami warning centers throughout much of the Pacific, the warning of a distant tsunami should be taken seriously, but you have to have your radio on to hear it. A coastal community is well advised to have a siren to warn those who aren't tuned in to their radio or television. This siren should be maintained by emergency-services or fire department personnel and should have its own generator.

In the case of an earthquake on the Cascadia Subduction Zone, you'll have a much shorter time to react—twenty minutes or less. For this reason, if your area is subjected to very strong shaking lasting twenty seconds or more, don't wait for a tsunami warning. Leave immediately for high ground and stay there for an hour or so until you're sure there is no local tsunami.

There is no direct correlation between tsunami height and magnitude of the earthquake. A subduction-zone earthquake off the Pacific coast of Nicaragua on September 2, 1992 generated an unusually large tsunami for the size of the earthquake. It was found

later that fault rupture was much closer to the surface, and fault motion took place much more slowly than for most subduction-zone earthquakes. In Papua New Guinea, coastal villagers were swept away by a tsunami generated by a landslide and by sea-floor deformation. Earthquakes like this are sometimes called *tsunami earthquakes*; the tsunami is much more extreme than the seismic shaking would predict.

The other problem in coping with tsunamis from a distant source is the period of the waves. Frequently, the first wave is not the largest one. The people of Crescent City, California found this out the hard way. The first and second waves were small and caused little damage and people returned to the shoreline, only to be struck by much larger waves that crashed through the town.

Unlike ordinary storm waves, the period of a tsunami wave can be as long as an hour. So when the first wave rushes up and then recedes, for the next half hour or so you will notice only the ordinary surf. But don't think the tsunami is over. Wait at least two hours before you return. And, just as a tsunami rises higher than ordinary waves, causing great damage, the tsunami also causes the water to recede much farther out to sea, exposing ocean floor not ordinarily seen even at the lowest tides (Fig. 9-9). The temptation to rush to the beach at that time could be fatal.

## II. Psychological Issues

Children are especially traumatized by earthquakes. Familiar surroundings—everything that is supposed to stay put in their lives—suddenly move, are damaged, or become a threat. Children might have to leave home for an extended period of time. They will fear that the shaking and destruction will get worse, or will happen again and again.

Assuring the physical safety of your child is only the first step. Include the child in all your activities, keep talking, and encourage the child to talk out fears. It might be necessary for your child to sleep with you for a few days until things return, more or less, to normal. Plenty of reassurance and just being present will help in overcoming your child's fears after an earthquake. Encourage the school to plan group activities that relate to psychological recovery from an earthquake.

Elderly or disabled persons also might feel a sense of helplessness and fear due to an earthquake. Some individuals of any age are prone to “disaster syndrome.” This illness might not come on immediately after the disaster, but it builds up over days and weeks, with evidence of the disaster everywhere and with the telling and retelling of the stories of the event. In severe cases, these people will need counseling and might need to leave the area until they have recovered.

## 12. Leaders in Earthquake Mitigation: Are You Ready To Step Forward?

I close this chapter with two people who are ordinary citizens, not earthquake scientists or engineers, but who took on the role of citizen leader.

The first is Diane Merten of Corvallis, a housewife with a large family, who began attending meetings at Oregon State University soon after the paradigm change recognizing the earthquake hazard facing the Northwest. Diane took it on herself to organize leaders in the city of Corvallis and in Benton County to prepare against earthquakes. This project was so successful that she was asked to lead other communities around the country in organizing themselves locally against disasters. Diane served as a citizen member of a committee appointed by the congressional Office of Technology Assessment evaluating the reauthorization of NEHRP.

The second is Roger Faris, a native of Seattle. In the early 1980s, Roger quit his general contracting business to develop a neighborhood home-remodeling cooperative in Phinney Ridge in Seattle. In the early 1990s, he met Brian Atwater, who told him about the earthquake dangers to the Northwest. When Project Impact started, Roger was the logical choice to develop a course in retrofitting homes against earthquakes. The course was taught regularly; the tuition is ten dollars. In 1999, he was honored by FEMA as Outstanding Citizen

of the Year, an award he received in Washington in Hawaiian shirt and khaki pants. As Inés Pearce of Seattle’s Project Impact put it, Roger is “one of those 1960s holdouts—a granola-headed idealist who puts his talent into building community rather than personal profit.”

We need more contractors like Roger, who can help people who want to strengthen their homes against earthquakes.

---

### *Suggestions for Further Reading*

American Red Cross. 1985. The emergency survival handbook. Available from your local Red Cross office.

Lafferty and Associates, Inc. 1989. Earthquake preparedness—for office, home, family, and community. Available from P.O. Box 1026, La Canada, CA 91012.

Morgan, L. 1993. Earthquake survival manual. Seattle: Epicenter Press. 160p.

National Science Teachers Association. 1988. Earthquakes: A teacher’s guide for K–6 grades. NSTA Publications, 1742 Connecticut Ave. NW, Washington, DC 20009.

Seismic Safety Commission. 1992. The Homeowner’s Guide to Earthquake Safety. SSC 92-01. 28p.

Yanev, P. 1974. Peace of Mind in Earthquake Country:



How to Save your Home and Life. San Francisco:  
Chronicle Books.

# 16. An Uncertain Appointment with a Restless Earth

*“Five minutes before the party is not the time to learn to dance.”*

Snoopy, 1982

*A catastrophic earthquake is coming to the Pacific Northwest!*

This shocking statement is surely true within a geologic time frame of thousands of years, because the evidence is strong that the Cascadia Subduction Zone will generate great earthquakes every few centuries. The last one was in A.D. 1700, three hundred years ago. The recognition that the Pacific Northwest is subject to large earthquakes was slow in coming, but since the 1980s, it has been accepted by the scientific community as a major paradigm change. As a result, the structural engineering community saw to it that building codes were upgraded, resulting in much higher safety standards than was the case a few years ago. The

governors of California, Oregon, and Washington and the premier of British Columbia would all agree now that there is an earthquake problem within their jurisdictions. Earthquake drills are conducted in schools, and partnerships are developing between government and private industry in taking steps to deal with the earthquake hazard, especially the Cascadia Subduction Zone. On October 15 of each year, states conduct a public exercise called ShakeOur, in which local communities, schools, and emergency responders act as though they have just experienced a major earthquake at 10:15 a.m.

Yet there is a feeling of unreality about it all, a feeling extending even to those whose careers are in earthquake studies and preparedness. For example, I know that the place where I live and work has a potential for earthquakes, yet I have not taken all the steps called for in Chapters 11 and 15 to safeguard my home and family against earthquakes. I asked a neighbor of mine, a well-known seismologist, whether he had earthquake insurance. He hung his head sheepishly and replied, “No.”

I had my own experience with an earthquake in 1978 in Mexico City, where my friend Chuck Denham and I were sitting in the bar of a small hotel, planning an ascent of Mount Popocatépetl. We were having a beer at nine o'clock in the morning because we didn't trust the water, and we didn't want to get sick halfway up the mountain.

Out of the corner of my eye I noticed a chandelier

start to sway. At first I thought I was imagining things, but then I gained enough confidence in my senses to say something to Chuck. At that instant, the first strong waves struck. Glasses and bottles toppled from the bar, chairs scraped back, and people began to yell in Spanish. The entire building began to rumble, like the noise of a train. *Earthquake*, I thought. The movement of the chandelier registered the P wave, and the strong shaking marked the S wave and the surface waves.

Despite all my wisdom about what to do in an earthquake, Chuck and I ran outside. I knew that it was the wrong thing to do, but rational behavior fled with the strong shaking. Fortunately, we were not bombarded by masonry or plate glass.

The scene in the street was surreal. The hotel was built very close to neighboring buildings, and each vibrated independently of the others so that their walls bounced together, like hands clapping. We waited for pieces of the building to fall off into the street, realizing at that instant how stupid it was for us to have run outside. Light poles waved back and forth. Parked cars rolled forward to hit the car in front, then backward to hit the car behind. The ground seemed like a thin sheet of plywood, bucking up and down, making it difficult to stand.

Then it was over. A siren wailed in the distance; otherwise it was deathly quiet. The buildings had not collapsed where we were, although we learned later that lives had been lost in other parts of the city.

Although aftershocks continued throughout the day,

the whole experience seemed unreal, as though we had seen a UFO or heard a ghost in the attic. To this day, I find it hard to believe that the earthquake actually happened, even though every part of the experience is as vivid today as it was more than three decades ago. It was like a bad dream.

Perhaps this is our problem about earthquakes. An earthquake is an act of devastation, like the destruction of the World Trade Center, which happened, caused great damage and loss of life, and then was over. It's difficult for us to recognize that the act of devastation that is a major urban earthquake is part of a continuum of Earth processes, of plate tectonics, of the raising of the Cascade and Olympic mountains and downwarp of the Seattle Basin.

The shaking of the Earth, a normal process to a geologist, is thought of as a bizarre aberration by everyone else—and perhaps even by geologists at the gut level, despite the knowledge gained by space satellites and seismographs. It is what scientists *feel* as opposed to what they *know*. Most people have only the feeling of unreality that an earthquake (or even the expectation of an earthquake) brings. An earthquake is so “unnatural” that it is almost impossible to believe, even when a person has experienced one.

One could describe this book as a morality play: the scientist points out the earthquake hazard to the public official, who refuses to take action, either through ignorance or greed. Taxpayers and their elected representatives refuse to pay for retrofit of buildings,

living for today and gambling that they will be long gone and out of the game before the earthquake arrives to cash in its chips.

Our cholesterol level or our blood pressure is too high, or we smoke too much. But our personal feeling is that heart attacks, strokes, and cancer will always happen to the other guy. So it is with earthquakes. Even though an earthquake strikes a blow to Seattle or San Francisco, it's unbelievable that an even larger earthquake might strike the entire coastal regions of Oregon, Washington, and Vancouver Island. It can't happen here.

Confronting the earthquake threat might be similar to visualizing the U.S. national debt. The debt is in the trillions of dollars and getting larger, and our children will be the ones who have to deal with it. But this threat is so unreal that, like earthquakes, we put it out of our mind and allow our politicians to continue spending borrowed money rather than pay off the debt.

When Nikita Khrushchev banged his shoe on a table at the United Nations and said about the Soviet Union, "We will bury you," there was a great media outcry, and many people began to build bomb shelters. After a while, though, the bomb shelter craze passed, even though the threat of nuclear annihilation increased. It didn't seem real, and then, when the Soviet Union collapsed, it turned out that it hadn't mattered after all. We ignored the nuclear threat, and for the most part it went away. Or not. There is still a major nuclear threat from the crisis between Ukraine and Russia, or between

China and smaller countries around the South China Sea.

Surely there is a middle path, and perhaps we are taking it. The upgrading of building codes and grading standards is an encouraging response of government to the earthquake problem. When the next earthquake strikes, I want to be in a building constructed under modern building codes rather than in an older building constructed under the weak codes of an earlier day. In a few generations, the older, unreinforced masonry buildings will be gone, and most wood-frame buildings will be bolted to their foundations. If an earthquake does not arrive beforehand, it might have proven sufficient.

The pressure needs to be kept on local, state, and national governments to protect their citizens against earthquakes, just as we now require protection against fires and windstorms. The Obama and Bush administrations have kept the spotlight on the war on terrorism, but one must recognize that a huge earthquake striking a West Coast city could be called natural terrorism. We must be sure that regional economies do not collapse and insurance companies are not forced out of business in the event of a great subduction-zone earthquake. Nuclear power plants, dams, hospitals, and government command centers must be able to operate after a major earthquake.

And, finally, research must continue into the sources of earthquakes, just as we must continue to support research toward a cure for AIDS or for cancer. The

Japanese took the Kobe Earthquake as a wake-up call, and they greatly boosted their efforts in preparedness and in research. But it was not enough. They underestimated the size of the March 11, 2011 subduction-zone earthquake off northeastern Japan. The result of this miscalculation was the loss of nearly 16,000 lives and the radioactive contamination of part of northeastern Japan because of the failure of the Fukushima Dai-ichi Nuclear Power Station.

North Americans have not done as much as the Japanese, perhaps because the national command centers and population centers in the United States and Canada are in the East, whereas the larger danger is in the West.

To be ready for our uncertain appointment with the next earthquake, we as taxpayers and voters need to keep the earthquake issue high on the list of priorities of our elected officials and our neighbors. A politician who fails to act must pay a political price before we all have to pay the ultimate price. For this to happen, we as a society must take an active role.

In response to the forthcoming earthquake, the Oregon legislature took some modest steps, including a “quick look” survey of public buildings, revealing that many are in danger of collapse in an earthquake. The 2011 legislature, led by Representative Debbie Boone of the north Oregon coast and Sen. Peter Courtney of Salem, authorized a *resilience survey*, completed in February, 2013, to estimate the cost of the next subduction-zone earthquake if little additional



preparation takes place: the cost of doing nothing. The short answer: the cost will be staggering and may cause a sharp decline across the entire economy of the Pacific Northwest for years, in large part because it would take a long time to get lifelines and critical facilities up and running. To avoid this catastrophic outcome, the paradigm shift among the general public, including the cost of preparation, must take place *now*, before the earthquake, not at some undefined time in the future.

The problem can be visualized by comparing the effects of a magnitude 9 earthquake in Cascadia and Superstorm Sandy on the middle Atlantic coast in October, 2012. The economic losses from Sandy, estimated a year after the storm to be \$65 billion, may be larger than the losses from the Cascadia earthquake because the value of the built environment, including the New York-Newark megacity, one of the largest in the world, is much higher than it is in the Northwest, even including the cities of Vancouver, Victoria, Seattle, and Portland. But the loss of life could be a hundred times worse. The loss of life in the United States from Sandy, not including those killed in the Caribbean, is estimated at 182. The loss of life in the Cascadia earthquake and tsunami will be in the thousands, possibly as high as ten thousand. One reason for this is that the U.S. Weather Service was able to predict that the Sandy storm track would turn inland at New Jersey and New York, and people were able to take precautions, including evacuation. Unless scientists suddenly figure out how to predict earthquakes, the

Cascadia earthquake would strike *without warning*. Cascadia would also be accompanied by strong ground shaking lasting several minutes, which was not an issue with Sandy.

A comparison with the Tohoku-oki Earthquake of magnitude 9 on March 11, 2011 is instructive. Japan's long history includes many earthquakes that have claimed tens of thousands of lives, including the 1923 Tokyo earthquake, in which more than 140,000 died. Because of its history and its culture, Japan is the best-prepared country on Earth against earthquakes. The deaths from the Tohoku-oki earthquake were nearly sixteen thousand, but these were mostly from the tsunami. Losses from strong shaking and building collapse were much lower than they would have been in the Pacific Northwest, because most Japanese buildings, including critical facilities, had already been strengthened against seismic shaking.

The magnitude 9 superquake and tsunami that devastated northeast Japan in 2011 was the same size as the 1700 AD earthquake and tsunami that struck Cascadia. Coastal Japanese communities subsided during the earthquake, permanently flooding streets near the sea, similar to the subsidence in 1700 measured by Brian Atwater along the Washington coast that drowned the coastal forest. The Pacific Northwest must plan for a subduction-zone earthquake the size of Tohoku-oki.

**The Next Cascadia Earthquake.** Several groups, including Oregon Emergency Management, have

attempted to visualize the next Cascadia earthquake through statewide training exercises. In 2011, Jerry Thompson and Simon Winchester presented a graphic and chilling account of this earthquake in *Cascadia's Fault*, a book Thompson published in 2011. But the Oregon Legislature wanted to know the length of time essential services would be down, and whether this would cause businesses to flee the state in order to survive? The resilience survey commissioned by the legislature illustrated the cost to Oregon of doing nothing or of taking only modest steps. The answers it gave to those questions were so catastrophic as to be almost unimaginable. They included a decline in the economy of the state lasting up to a generation. Although this survey was limited to Oregon, its implications apply fully to Washington, which has completed its own resilience survey, to northern California, and to coastal British Columbia.

The resilience survey was directed by the Oregon Seismic Safety Policy Advisory Commission (OSSPAC), which created eight working groups of citizens from government, universities, the private sector, and the general public to examine the impacts on business, the energy sector, transportation and lifelines, water and wastewater pipelines, communications, and critical facilities, with a special focus on the coast. Each group was asked to assess the impact on its respective sector, including the time required to restore function to the way it had been prior to the earthquake.

An earthquake of magnitude 9 would cause violent

shaking for three to five minutes along the entire Northwest coast from northern California to central Vancouver Island, causing severe damage to unreinforced masonry (URM) buildings and wood-frame houses not bolted to their foundations. The strong shaking would be accompanied by landsliding and liquefaction, which would rupture underground utilities, including water and sewer lines. Gas escaping from underground gas lines broken by liquefaction would catch fire, as occurred in the Mission District of San Francisco after the Loma Prieta earthquake of 1989.

The earthquake would be followed about twenty minutes later by a tsunami that would be similar to the Tohoku-oki tsunami that caused thousands of deaths in Japan. The tsunami would overwhelm parts of low-lying towns like Tillamook, Astoria, Seaside, Cannon Beach, Coos Bay, and Newport (ironically including the NOAA tsunami research center at the Hatfield Marine Science Center at Newport), all of which are in the expected tsunami runup zone. The Oregon resilience survey concluded that the zone of tsunami inundation would include more than ten thousand housing units with a resident population greater than 22,000. Also inundated would be nearly 1,900 businesses employing nearly 15,000 people. The coast would subside abruptly and permanently by five to ten feet, as it did after the last great earthquake in 1700 AD (and as the Tohoku coast of Japan did in 2011). The estimated losses in Oregon alone would be \$32 billion.

Washington losses estimated by the Federal

Emergency Management Agency (FEMA) would be \$49 billion, larger than Oregon's because of the higher value of property at risk. Adding in northern California and southwest British Columbia, the economic losses could bankrupt the insurance industry and severely damage the economies of all the affected states or provinces as well as the national economies of the United States and Canada. Only the California part of the subduction zone has taken steps to upgrade its dangerous buildings.

The Oregon resilience survey showed that of the 2,567 highway bridges in Oregon, 982 were built without any seismic considerations, and only 409 were designed specifically with Cascadia subduction-zone earthquakes in mind. The vulnerability of Northwest bridges was brought home to the public on May 24, 2013, when an Interstate 5 bridge near Mount Vernon, in western Washington, collapsed into the Skagit River due to a truck colliding with the bridge superstructure. Since that disaster, many bridges in the Pacific Northwest have been declared as "obsolete," indicating that examination of bridges should include their resistance to earthquake shaking.

The resilience survey concluded that many bridges on the coast would collapse in an earthquake, isolating coastal communities from one another and from rescue operations launched from inland cities not damaged by the earthquake. Submarine cables would be cut, isolating the Northwest from Alaska and other parts of the Pacific Ring of Fire. The earthquake would instantly damage or destroy electric power lines, natural gas

lines, water and sewer systems, hospitals, police stations, and school buildings. 24,000 buildings would be completely destroyed, and another 85,000 would be damaged so extensively that they would take months to years to repair. In summary, the earthquake, even a smaller one affecting only that part of the subduction zone in southern Oregon and northern California, would be a major catastrophe.

According to the Oregon resilience survey, it would take one to three years to restore drinking water and sewer service to the coast and one month to one year to restore water and sewer service to the Willamette Valley and Portland. Restoring the top priority highways to at least partial function would take six to twelve months, and restoring police and fire stations in the Valley would take four months. Restoring electricity and natural gas to the coast would take three to six months, and restoration of health-care facilities to operational status would take eighteen months in the Willamette Valley and three years on the coast. Comparable estimates of recovery time were made independently in the resilience survey for the state of Washington. (Northern California differs only in a program authorized by the Legislature to replace URM buildings, a program now underway.) These resilience surveys were combined by the Cascadia Region Earthquake Workgroup (CREW) in a single publication, *Cascadia Subduction Zone Earthquakes: A Magnitude 9.0 Earthquake Scenario*, which was independently published by the geological surveys of Washington,

Oregon, and British Columbia. The CREW report used the response of Chile to a superquake of magnitude 8.8 in 2010, important to the Northwest because Chile is a developed country that has experienced subduction-zone earthquakes. This report is sobering to read, but should be read by all living in the Northwest to accelerate the paradigm shift among the general public. In May, 2015, Chile experienced an earthquake of magnitude 8.3 that cost the lives of eight people. A similar earthquake in the same region in 1939 took more than 20,000 lives. For Chile, preparation paid off.

Regarding highways, the main highway between the Willamette Valley and Newport is now being retrofitted, but failure to recognize landslides along the route has led to delays in completion of several years and an increase in the construction costs so large that the Oregon Department of Transportation considered abandoning the project after investing millions of dollars in it.

The length of time required to restore services, including transportation lifelines, means that those businesses that had not already failed due to building damage or tsunami flooding could not afford to stay and would start to leave Oregon and Washington after about a month. As businesses left, people would also leave, following the jobs to locations not affected by the earthquake. The result would be a loss of population and a declining economy that might take a generation to recover. This, then, is the true cost of not

strengthening lifelines and public structures against the inevitable earthquake.

Smaller-scale examples of a similar scenario include two major storms, Hurricane Katrina in 2005 and Superstorm Sandy in 2012. Katrina and Sandy differ from the Cascadia earthquake in that warnings were issued by the U.S. Weather Service, but there was no warning of some of the most catastrophic effects, including the failure of levees on the Mississippi River near New Orleans, the tsunami-like storm surge against coastal towns in Mississippi and, for Sandy, the storm surge flooding neighborhoods in coastal New Jersey and New York State. The death toll from Katrina was 1,464 people. 70,000 jobs were lost, and the damage was \$128 billion. Evacuation to other parts of the country caused the population of New Orleans to shrink from 445,000 to 312,000 two and a half years later. Removal of floodwaters and repair and strengthening of the levees were (and still are) long-term and costly undertakings.

Hurricane Sandy was also a catastrophe from which it will take many months if not years to recover. A year after the storm, many homes are still in ruins, and homeowners are in litigation with their insurance companies and in arguments with local government over how much help government should provide them. Should the coast be rebuilt just as it was, or should a broader section be left undeveloped in the event of another Sandy, as suggested by Professor Orrin Pilkey of Duke University, an expert in the hazards of



development along coastlines? The coastal boardwalks of New Jersey cities are the sites of many small businesses as well as large casinos, indicating major damage to the tourist industry. Can these businesses survive?

The Cascadia earthquake differs from Katrina and Sandy in one more way: the affected area would be hundreds of times larger.

The lesson of the resilience studies of Oregon and Washington is that there is a monstrous price tag attached to doing nothing or taking only token steps. Failure to strengthen lifelines, including bridges and utility networks, city halls, police stations, school buildings, and hospitals, has a huge cost: a decades-long decline of the Northwest economy. If industry is forced to leave the Northwest, then one must factor in sharply lower tax revenues and sharply higher unemployment. This will require outside assistance to the Northwest and British Columbia from the national governments of the United States and Canada. Both countries would be required to play a major financial role in recovery and, for the United States government, would defer the reduction of the national debt, currently one of its highest political priorities.

The Federal government has taken a large role in the process of recovery from Katrina and is expected to take a major role in the recovery from Sandy, at least in the most devastated states of New York and New Jersey. A bill in Congress to provide more than 60 billion dollars for recovery in New York and New Jersey failed

to pass due to congressional dithering about the fiscal cliff. The bill was only passed months later a result of public outrage against Congress for failing to take action. It was not an encouraging sign for how the federal government in Washington would respond to the Cascadia earthquake in the faraway Northwest.

A more realistic comparison of the destruction from the next Cascadia earthquake is the firebombing of Japanese cities in the late stages of World War II or the devastation of the economy of the southern United States caused by the Civil War. These were disasters affecting the economy on a national scale. In each case, recovery took decades, at least a generation.

Unfortunately, science cannot tell whether the Cascadia earthquake will strike tomorrow or a century from now, but science can say, without a doubt, that *there will be a major subduction-zone earthquake in the near future*. If the paradigm shift about the next Cascadia earthquake is to be realized among the general population of the Northwest, action must begin *now*. This means that the forthcoming earthquake needs to be debated and dealt with by the state and provincial legislatures, by civic leaders, by the media, and by the public at large, because it will require taxpayer dollars, including assistance from the Federal governments of Canada and the United States. It will require a financial commitment from society, both at the state and provincial level and at the national level, to prepare for the next earthquake *now* so that when it strikes, it will be a manageable crisis. At the present

time, the Oregon resilience survey has not led to any action by the Oregon Legislature. Even though the survey was presented to the Oregon legislature during the 2013 session, no bills have been introduced to deal with the problem, and the state media have not taken the Legislature to task for ignoring the problem. Same for the Washington resilience survey. A transportation bill, which would have included retrofits of bridges identified by the resilience survey, failed to pass or even to be debated by the 2015 Legislature. The *Oregonian* newspaper did not take the Legislature to task on this issue.

The Washington State resilience survey contains recommendations on responding to the earthquake threat in the next 50 years. The actions to be taken include responses by the office of the governor and the state legislature, which will in turn require a financial sacrifice by the residents of the state. This involvement assumes that the Governor and Legislature will have the political will to act on the recommendations of the resilience survey, including providing the necessary resources. It also assumes that the citizens will recognize what needs to be done *in advance* of the earthquake and will demand action by their elected leaders. Will they? The same question may be asked in Oregon, northern California, and British Columbia, although California is already taking steps to eliminate its inventory of URM buildings.

As a resident of the Northwest, I find the failure to take meaningful action against this threat unacceptable

and irresponsible. Will we and our elected officials rise to the challenge? Can my colleagues and I make a more convincing case leading to action?

My colleague at the University of Tokyo, Professor Yasutaka Ikeda, warned his countrymen in advance that the Tohoku region of northeast Japan should be preparing for a subduction-zone earthquake of magnitude 9, not 8 to 8.4. After the earthquake, I asked him if he was telling his countrymen “I told you so.” He sadly said no, that he blamed himself for not doing a better job of convincing the Japanese authorities and the general public. To him, his inability to make the case to his countrymen for a magnitude 9 in advance was the greatest failure of his long and distinguished career.

I have similar concerns.

The Oregon and Washington resilience surveys laid out a plan to strengthen the state against the inevitable Cascadia earthquake in the next fifty years. If we start now, there is a probabilistic 90% chance we can strengthen ourselves against the next earthquake before it happens, if our probability estimates are correct. But at the present time, this is not on the Legislature’s to-do list in either state. No bills have been introduced, no legislative committees have been established to make recommendations to state government, and no attempt has been made by state politicians to raise the money. There is also no demand by the general public for state officials to address the threat of the next Cascadia earthquake. The paradigm shift has not yet occurred.

The southern part of the subduction zone is in California, which experienced a small subduction-zone earthquake in 1992. Since 1986, state legislation has required local jurisdictions in harm's way from earthquakes to conduct inventories of hazardous unreinforced-masonry buildings and to remove these buildings from use. The City of Eureka has had a program since 1989, and most of the buildings identified in Eureka's inventory have now been retrofitted. In addition, in 2003, the City of Vancouver installed a dedicated fire-protection system that will allow firefighters to pump water from two nearby creeks, important because of the danger of fire after a major urban earthquake.

California has taken small but important steps. But no comparable program exists in Oregon or Washington.



# Appendix A: Significant Historical Earthquakes in the Pacific Northwest

| <b>Date</b>          | <b>Magnitudes</b> | <b>Source</b> | <b>Comments</b>                                |
|----------------------|-------------------|---------------|--|
| Jan .<br>26,<br>1700 | 9                 | SZ            | Dated by Japanese tsunami                      |
| Oct.<br>23,<br>1853  | 5.7               | ?             | Eureka area, wharf sank 4 feet, intensity VII  |
| Mar.<br>20,<br>1855  | ?                 | ?             | Eureka, intensity VI, affected flow of streams |
| Jun.<br>14,<br>1857  | ?                 | ?             | Eureka, intensity VI                           |
| Nov.<br>13,<br>1860  | 5.7               | ?             | Humboldt Bay, chimney, plaster damage, VII     |
| Oct.<br>29,<br>1864  | 5.5               | SC            | Georgia Strait                                 |
| Oct. 1,<br>1865      | 5.4-5.7           | ?             | Eureka, fissure Ft. Humboldt, VII-VIII         |
| Mar.<br>2, 1871      | 5.9               | ?             | Petrolia, damage Rohnerville, intensity VIII   |
| Dec.<br>15,<br>1872  | 6.8               | CR            | Entiat, WA                                     |
| Nov.<br>23,<br>1873  | 6.7               | SC            | CA-OR border, damage to Crescent City          |
| Sep.<br>30,<br>1875  | 5.8               | ?             | SE of Eureka, intensity VII                    |
| Oct.<br>12,<br>1877  | 5.2               | CR            | Portland, OR, intensity VII, 2 events          |



|                     |         |     |  |
|---------------------|---------|-----|--|
| May<br>9,<br>1878   | 5.8     | TF  | Mendocino FZ, chimneys<br>collapsed in Petrolia, CA            |
| Apr.<br>30,<br>1882 | <6?     | SC? | South Puget Sound  |
| Jan.<br>28,<br>1884 | 5.7     | ?   | N. of Hoopa, intensity V                                       |
| Jul.<br>25,<br>1890 | 6       | ?   | Damage at Ferndale and<br>Petrolia, CA                         |
| Nov.<br>29,<br>1891 | ?       | ?   | Puget Sound  |
| Sep.<br>30,<br>1894 | 5.6-5.8 | ?   | Near Miranda, S. Humboldt<br>Co.                               |
| Jan. 3,<br>1896     | 5.3     | ?   | N. Puget Sound   |
| Apr.<br>15,<br>1898 | 6.8     | ?   | Mendocino coast, Ft.<br>Bragg-Greenwood,<br>intensity IX       |
| Apr.<br>16,<br>1899 | 6.4     | SO  | Offshore Arcata, damage to<br>Eureka, CA, Gorda Plate          |
| Dec.<br>9,<br>1903  | ?       | SO  | Offshore Eureka  |
| Mar.<br>17,<br>1904 | 5.3     | ?   | 60 km NW Seattle, intensity<br>VII                             |
| Apr.<br>23,<br>1906 | 6.4     | ?   | McKinleyville, Ferndale,<br>Eureka, Trinidad, intensity<br>VII |

|                     |         |    |   |
|---------------------|---------|----|---|
| Jan.<br>11,<br>1909 | 6       | SC | San Juan and Gulf islands,<br>intensity VII             |
| May<br>18,<br>1909  | ?       | ?  | Petrolia, chimneys<br>damaged, intensity VIII           |
| Oct.<br>28,<br>1909 | 6.4     | ?  | Rio Dell, Rohnerville, Upper<br>Mattole, intensity VIII |
| Mar.<br>19,<br>1910 | 6       | SO | Offshore Petrolia, intensity<br>V                       |
| Aug.<br>22,<br>1914 | 6.75    | TF | Blanco Fracture Zone                                    |
| Dec.<br>31,<br>1915 | 6.2-6.5 | ?  | Offshore Cape Mendocino                                 |
| Jun.<br>10,<br>1917 | 6.5     | TF | Blanco Fracture Zone                                    |
| Aug.<br>18,<br>1915 | 5.6     | CR | North Cascades, VII                                     |
| Jul. 15,<br>1918    | 6-6.5   | SO | Offshore Arcata, VI                                     |
| Dec.<br>6,<br>1918  | 7       | CR | Vancouver Island W. coast                               |
| Sep.<br>15,<br>1919 | ?       | ?  | Eureka, Chimneys fell,<br>intensity VI                  |
| Jan.<br>24,<br>1920 | 5.5     | SC | Georgia Strait  |

|                     |         |     |   |
|---------------------|---------|-----|---|
| Jan.<br>26,<br>1922 | 6       | TF? | Offshore Cape Mendocino                             |
| Jan.<br>31,<br>1922 | 7.3-7.6 | SO  | 37 mi. W of Arcata, CA, VI,<br>felt Klamath Falls   |
| Jan.<br>22,<br>1923 | 6.5-7.3 | TF  | Mendocino FZ; damage at<br>Petrolia, intensity VIII |
| Feb.<br>24,<br>1924 | 5.75    | TF  | Blanco Fracture Zone                                |
| Jun. 4,<br>1925     | 6       | ?   | Offshore W of Orick, CA                             |
| Jun. 5,<br>1926     | 6       | TF  | Blanco Fracture Zone                                |
| Dec.<br>10,<br>1926 | 6       | SO  | Gorda Plate, 80 mi. W of<br>Eureka, CA              |
| Feb.<br>9,<br>1928  | 5.8     | SC? | SW Vancouver Island                                 |
| Sep.<br>11,<br>1928 | 6.3     | TF  | Blanco Fracture Zone                                |
| May<br>26,<br>1929  | 7.0     | TF  | SE end of Queen Charlotte<br>Fracture Zone          |
| Sep.<br>23,<br>1930 | 5-5.5   | ?   | Chimneys fell in Eureka, VII                        |
| Mar.<br>10,<br>1931 | 5.6     | ?   | Offshore C. Mendocino                               |

|                     |         |     |  |
|---------------------|---------|-----|--|
| Sep.<br>9, 1931     | 5.8     | ?   | Offshore Eureka, chimneys<br>damaged, intensity VI |
| Mar.<br>2,<br>1932  | 5.6     | TF? | 112 mi W. C. Mendocino                             |
| Jun. 6,<br>1932     | 6.4     | SC  | One death at Arcata,<br>damage at Eureka           |
| Jun.<br>20,<br>1932 | 5.5     | TF  | Blanco Fracture Zone                               |
| Jul. 17,<br>1932    | 5.2     | CR  | Duvall, NE of Seattle, VII                         |
| Mar.<br>26,<br>1933 | 5.5     | TF  | Blanco Fracture Zone                               |
| Jul. 6,<br>1934     | 6.5     | SO  | 56 mi. W of Trinidad, CA                           |
| Jan. 2,<br>1935     | 5.8     | ?   | Offshore C. Mendocino,<br>intensity V              |
| Apr.<br>30,<br>1936 | 5.5     | TF  | Blanco Fracture Zone                               |
| Jun. 3,<br>1936     | 5.8     | TF? | 93 mi. W. C. Mendocino                             |
| Jul. 16,<br>1936    | 5.1-5.5 | CR  | Milton-Freewater, near<br>OR-WA border             |
| Sep.<br>25,<br>1936 | 6.2     | TF  | Blanco Fracture Zone                               |
| Nov.<br>5,<br>1936  | 6       | TF  | Blanco Fracture Zone                               |

|                     |         |    |  |
|---------------------|---------|----|--|
| Feb.<br>6,<br>1937  | 5.7-5.8 | ?  | Offshore C. Mendocino,<br>slight damage    |
| Nov.<br>10,<br>1937 | 5.75    | TF | Blanco Fracture Zone                       |
| Aug.<br>3,<br>1938  | 5.6     | TF | Blanco Fracture Zone                       |
| Sep.<br>11,<br>1938 | 5.5     | ?  | SE C. Mendocino, slight<br>damage Ferndale |
| Nov.<br>13,<br>1939 | 5.5-6.2 | SC | Puget Sound region,<br>intensity VII       |
| Nov.<br>17,<br>1940 | 6       | TF | Blanco Fracture Zone                       |
| Nov.<br>19,<br>1940 | 5.5     | ?  | Offshore C. Mendocino,<br>slight damage    |
| Feb.<br>9, 1941     | 6.4-6.6 | SO | 60 mi. W of Eureka, NW C.<br>Mendocino     |
| May<br>13,<br>1941  | 6       | ?  | Offshore C. Mendocino                      |
| Oct.<br>2, 1941     | 6.4     | SC | 30 mi. W of C. Mendocino                   |
| Oct.<br>31,<br>1941 | 5.5     | TF | Blanco Fracture Zone                       |
| Mar.<br>6,<br>1944  | 5.75    | TF | Blanco Fracture Zone                       |

|                     |         |    |   |
|---------------------|---------|----|---|
| Dec.<br>30,<br>1944 | 5.75    | TF | Blanco Fracture Zone                    |
| Apr.<br>29,<br>1945 | 5.9     | CR | 50 km SE of Seattle,<br>intensity VII   |
| May<br>19,<br>1945  | 6.2     | ?  | Offshore C. Mendocino                   |
| Feb.<br>15,<br>1946 | 5.6-6.4 | SC | Puget Sound region                      |
| Jun.<br>23,<br>1946 | 7.3     | CR | Central Vancouver Island                |
| Sep.<br>23,<br>1947 | 5.6     | ?  | Offshore C. Mendocino,<br>intensity VII |
| May<br>25,<br>1948  | 5.5     | TF | Blanco Fracture Zone                    |
| May<br>25,<br>1948  | 5.8     | TF | Blanco Fracture Zone                    |
| Mar.<br>24,<br>1949 | 5.9     | SO | 93 mi. W of Orick                       |
| Apr.<br>13,<br>1949 | 7.1     | SC | Olympia, WA, intensity VIII             |
| Aug.<br>22,<br>1949 | 8.1     | TF | Queen Charlotte Fracture<br>Zone        |

|                     |         |    |   |
|---------------------|---------|----|---|
| Aug.<br>24,<br>1949 | 5.5     | TF | Blanco Fracture Zone                              |
| Feb.<br>23,<br>1951 | 5.6     | TF | Blanco Fracture Zone                              |
| Jun.<br>16,<br>1951 | 5.5     | TF | Blanco Fracture Zone                              |
| Jun.<br>17,<br>1951 | 6       | TF | Blanco Fracture Zone                              |
| Oct.<br>8, 1951     | 5.8-6   | TF | 10 mi W Petrolia; 6 mi W of<br>Punta Gorda        |
| Aug.<br>20,<br>1952 | 6       | TF | Blanco Fracture Zone                              |
| Nov.<br>25,<br>1954 | 6.1-6.3 | TF | 65 mi. W Punta Gorda,<br>Mendocino Fracture Zone  |
| Dec.<br>21,<br>1954 | 6.5-6.6 | CR | \$3.1 million damage, 1<br>death, 12 mi NE Arcata |
| Aug.<br>23,<br>1955 | 6.25    | TF | Blanco Fracture Zone                              |
| Feb.<br>19,<br>1956 | 6.8     | SO | Pacific Plate NW of<br>Vancouver Is.              |
| Oct.<br>11,<br>1956 | 6       | ?  | NW of C. Mendocino, slight<br>damage Ferndale     |
| Dec.<br>21,<br>1956 | 6.7     | SO | small plate near Queen<br>Charlotte Fracture Zone |

|                        |         |    |  |
|------------------------|---------|----|--|
| Dec.<br>16,<br>1957    | 5.9     | SO | W. of Vancouver Is., NE of<br>Nootka Fault |
| Jul.<br>23,<br>1959    | 5.8     | SO | 56 mi. W Trinidad, CA                      |
| Aug.<br>5,<br>1959     | 5-5.5   | CR | near Chelan, WA, intensity<br>VI           |
| Sep.<br>26,<br>1959    | 6.1     | TF | Blanco Fracture Zone                       |
| Jun. 5,<br>1960        | 5.7     | SO | Offshore Arcata, intensity<br>VI           |
| Aug.<br>9,<br>1960     | 6-6.2   | TF | Felt S. OR to San Francisco                |
| Apr. 6,<br>1961        | 5-5.5   | TF | 11 mi W C. Mendocino,<br>landslides        |
| Aug.<br>23,<br>1962    | 5.6     | SO | Offshore Crescent City                     |
| Nov.<br>5,<br>1962     | 5.2-5.5 | CR | OR-WA border near<br>Portland, OR, VII     |
| Jul. 13,<br>1964       | 5.5     | TF | Blanco Fracture Zone                       |
| Oct. 1,<br>1964<br>5.5 | 5.5     | TF | Blanco Fracture Zone                       |
| Oct.<br>29,<br>1964    | 5.5     | SC | Georgia Strait                             |



|                     |         |     |   |
|---------------------|---------|-----|---|
| Apr.<br>29,<br>1965 | 6.5     | SC  | Seattle, WA, intensity VIII                 |
| May<br>31,<br>1965  | 5.5     | TF  | Blanco Fracture Zone                        |
| Dec.<br>10,<br>1967 | 5.6-5.8 | TF  | 12 mi. W. of Petrolia, CA,<br>slight damage |
| May<br>8,<br>1968   | 6.1     | TF  | Blanco Fracture Zone                        |
| Jun.<br>26,<br>1968 | 5.5-5.9 | TF  | Offshore C. Mendocino                       |
| May<br>8,<br>1969   | 5.5     | TF  | Blanco Fracture Zone                        |
| Jun.<br>24,<br>1970 | 7.4     | TF? | Queen Charlotte TF or N.<br>America Plate   |
| Nov.<br>26,<br>1970 | 6       | TF  | Blanco Fracture Zone                        |
| Mar.<br>13,<br>1971 | 6.1     | SO  | W. of Vancouver Island                      |
| Jul.<br>23,<br>1972 | 6.4     | SO  | W. of Vancouver Island                      |
| Jun. 7,<br>1975     | 5.2-5.7 | SC  | Fortuna, CA                                 |
| Nov.<br>26,<br>1976 | 6.3     | SO  | Gorda Plate, 93 mi. NW of<br>Eureka         |

|                     |         |    |   |
|---------------------|---------|----|---|
| Dec.<br>9,<br>1976  | 5.5     | TF | Blanco Fracture Zone                            |
| Dec.<br>20,<br>1976 | 6.7     | SO | W. of Vancouver Is.                             |
| Jun. 2,<br>1978     | 5.5     | CR | Brooks Peninsula, NW<br>Vancouver Is.           |
| Jul.<br>25,<br>1978 | 5.5     | CR | Brooks Peninsula, NW<br>Vancouver Is.           |
| May<br>18,<br>1980  | 5.1     | CR | Eruption of Mt. St. Helens                      |
| Nov.<br>8,<br>1980  | 6.9-7.4 | SO | 30 mi. W Trinidad, \$1.75<br>million damage     |
| Dec.<br>17,<br>1980 | 6.8     | SO | W. of Vancouver Is.                             |
| Feb.<br>14,<br>1981 | 5.5     | CR | Elk Lake, WA on St. Helens<br>seismic zone      |
| Nov.<br>3, 1981     | 6.4     | TF | Blanco Fracture Zone                            |
| Aug.<br>24,<br>1983 | 5.5     | TF | Offshore C. Mendocino                           |
| Sep.<br>10,<br>1984 | 6.6     | TF | 166 mi W of Eureka, felt OR<br>to San Francisco |
| Mar.<br>13,<br>1985 | 6.3     | TF | Blanco Fracture Zone                            |

|                     |         |             |  |
|---------------------|---------|-------------|--|
| Jul. 31,<br>1987    | 5.5     | SO or<br>SC | Just off C. Mendocino  |
| Oct.<br>23,<br>1988 | 5.5     | TF          | Blanco Fracture Zone   |
| Jul 13,<br>1991     | 6.7-6.9 | SO          | 50 mi WNW of Crescent<br>City                                |
| Aug.<br>16,<br>1991 | 5.9-6.3 | SO          | 62 mi W of Crescent City                                     |
| Aug.<br>17,<br>1991 | 6.2     | CR          | Honeydew, CA, chimney,<br>foundation damage                  |
| Aug.<br>17,<br>1991 | 6.9-7.1 | SO          | 62 mi W of Crescent City                                     |
| Mar.<br>7,<br>1992  | 5.3-5.6 | CR          | S. of Petrolia, landslides,<br>foundation damage             |
| Apr. 6,<br>1992     | 6.8     | TF          | W. Vancouver Is.,<br>Revere-Dellwood-Wilson<br>Fracture Zone |
| Apr.<br>25,<br>1992 | 7.1     | SZ          | Tsunami, coastal uplift, \$48<br>million damage              |
| Apr.<br>26,<br>1992 | 6.6     | SO          | 17 mi. WNW Petrolia,<br>damage to Scotia                     |
| Apr.<br>26,<br>1992 | 6.7     | SO          | 16 mi. W Petrolia, added<br>damage                           |
| Aug.<br>21,<br>1992 | 5.5     | TF          | Blanco Fracture Zone   |

|                     |         |    |  |
|---------------------|---------|----|--|
| Mar.<br>25,<br>1993 | 5.6     | CR | Scotts Mills, OR, E of Salem                       |
| Apr.<br>26,<br>1993 | 6.5     | SO | 15 mi W of Petrolia                                |
| Sep.<br>20,<br>1993 | 6       | TF | Mendocino Fracture Zone,<br>85 mi W C. Mendocino   |
| Sep.<br>20,<br>1993 | 5.9, 6  | CR | 2 eqs. W. Klamath Falls, OR                        |
| Sep. 1,<br>1994     | 6.9-7.2 | TF | 88 mi. W C. Mendocino, felt<br>OR to San Francisco |
| Oct.<br>27,<br>1994 | 5.6     | TF | Blanco Fracture Zone                               |
| Feb.<br>18,<br>1995 | 6.6     | SO | 88 mi. WSW Eureka                                  |
| Jul.<br>24,<br>1996 | 6       | SO | 115 mi. W Crescent City                            |
| Jan.<br>21,<br>1997 | 5.7     | TF | 1 mi NW of Punta Gorda                             |
| Oct.<br>4,<br>1997  | 5.7     | SO | 65 mi. W Trinidad, CA                              |
| Nov.<br>27,<br>1998 | 5.6     | SO | 60 mi. W Ferndale, CA                              |
| Jul. 2,<br>1999     | 5.8     | SC | Satsop, WA   |

|                     |     |    |   |
|---------------------|-----|----|---|
| Jan.<br>20,<br>2000 | 6.1 | TF | Blanco Fracture Zone                              |
| Mar.<br>16,<br>2000 | 5.9 | TF | 52 mi W Petrolia                                  |
| Jun. 2,<br>2000     | 6.2 | TF | Blanco Fracture Zone                              |
| Jan.<br>13,<br>2001 | 5.6 | SO | 62 mi. W Eureka                                   |
| Feb.<br>28,<br>2001 | 6.8 | SC | Nisqually Earthquake, S.<br>Puget Sound, VII-VIII |
| Jul. 9,<br>2002     | 6   | TF | Blanco Fracture Zone                              |
| Sep.<br>2,<br>2002  | 5.7 | TF | Blanco Fracture Zone                              |
| Jan.<br>16,<br>2003 | 6.2 | TF | Blanco Fracture Zone                              |
| Nov.<br>19,<br>2007 | 5.8 | TF | Blanco Fracture Zone                              |
| Mar.<br>30,<br>2008 | 5   | TF | Blanco Fracture Zone<br>(swarm)                   |
| Mar.<br>8,<br>2011  | 5.0 | TF | Blanco Fracture Zone                              |
| Oct.<br>27,<br>2012 | 7.8 | TF | Queen Charlotte Fracture<br>Zone                  |

|                     |     |    |  |
|---------------------|-----|----|--|
| Apr.<br>24,<br>2014 | 4.8 | TF | Queen Charlotte Fracture<br>Zone       |
| Nov.<br>27,<br>2014 | 4   | CR | Sheldon Wildlife Refuge, NV<br>(swarm) |
| Jan.<br>28,<br>2015 | 5.7 | TF | Mendocino Fracture Zone                |

---

Magnitudes for pre-seismograph earthquakes are corrected intensity magnitudes where available. Key to source: CR, crustal; SO, slab, offshore; SC, slab, beneath the continent; SZ, subduction zone; TF, transform fault

# Appendix B: Glossary

see [glossary](#).

# Appendix C: Credits

- **A Concept of Time:** Standard textbooks on historical geology were used in this chapter. The idea of visualizing time in progressively increasing increments was used by C. R. Pellegrino in his book, *Time Gate: Hurling Backward through History*.
- **Plate Tectonics:** The basic information is provided in textbooks, some of which are cited. The plate tectonics of California for the past thirty million years has been worked out by Tanya Atwater of the University of California Santa Barbara, William R. Dickinson of the University of Arizona, and many others. Atwater has produced a video, included in this book as Figure 2-8.
- **Earthquake Basics:** Most of this is based on textbooks in structural geology and seismology. For structural geology, see Yeats et al. (1997), and for seismology, see Bolt (2004), Brumbaugh (1999), and Hough (2002); these textbooks discuss the subjects at a very basic level, suitable for the nonscientist. GPS is too new to be featured in a textbook except for Yeats et al. (1997). I received help from Meghan Miller, then of Central Washington University, and Herb Dragert of Pacific Geoscience Centre. Bill Bakun of the USGS reviewed the section on the use of intensities to



determine magnitudes of pre-instrumental earthquakes, a technique he developed with Carl Wentworth, also with the USGS.

- **The Subduction Zone: The Big One:** The major contributors to the recognition of the Cascadia Subduction Zone as a major earthquake source have been acknowledged in the text of this chapter. In addition to Brian Atwater, Harvey Kelsey of Humboldt State University, Curt Peterson of Portland State University, Mark Darienzo, then of Oregon Emergency Management, John Clague of Simon Fraser University, and Chris Goldfinger of Oregon State University have contributed much to an understanding of the Cascadia Subduction Zone thrust. Native American oral traditions about earthquakes are being collected by Ruth Ludwin of the University of Washington and Deborah Carver of Humboldt State University. Bob Dziak of NOAA and OSU contributed information about SOSUS, the hydrophone arrays to detect earthquakes at sea.
- **Earthquakes in the Juan de Fuca Plate:** Bob Crosson of the University of Washington was one of the first to recognize earthquakes in the Juan de Fuca Plate beneath Puget Sound. Others contributing much to the understanding of these earthquakes include Ken Creager of the University of Washington, Anne Tréhu of Oregon State University, and Roy Hyndman of the Pacific

Geoscience Centre. Ivan Wong of URS Greiner and Associates shared his ideas about why Oregon lacks large slab earthquakes. Newspaper stories collected by Kathy Troost and Derek Booth helped me write the account of the Nisqually Earthquake. Accounts of the 1949 and 1965 earthquakes were based on archives of the *Seattle Times*.

- **Earthquakes in the Crust: Closer to Home:**

Although the principal contributors to an understanding of Puget Sound faulting are acknowledged in the text, the earliest contribution was the work of Howard Gower and Jim Yount of the USGS in the 1980s. I learned much from Brian Sherrod about the Seattle Fault and Toe Jam Hill Fault, both in e-mail exchanges and in the field; a field trip led by Sherrod and by Harvey Kelsey and Alan Nelson was also instructive. Ian Madin of DOGAMI was principally responsible for mapping the active faults of the Portland Basin, and my students Paul Crenna, Erik Graven, Tom Popowski, and Ken Werner mapped the faults of the Willamette Valley and Tualatin Valley. Scott Burns of Portland State University helped my understanding of landslides in western Oregon and Washington. Chuck Newell provided me his unpublished history of the discovery of the Mist Gas Field. The main contributors along the coast were Chris Goldfinger of Oregon State University, Lisa McNeill, now of Southampton University, Pat McCrory of the USGS, and Gary Carver of

Humboldt State University. Ruth Ludwin reviewed the section in the second edition on the 1872 Entiat Earthquake and contributed Native American stories possibly related to the last Seattle Fault earthquake. Bob Bentley of Central Washington University argued for active faulting in the Yakima Fold Belt at a time when that view was unpopular. Steve Reidel, now of Washington State University at Richland, added much to my understanding of the Yakima Fold belt. Ray Weldon and Silvio Pezzopane of the University of Oregon have been responsible for mapping the normal faults of eastern Oregon, building on earlier work by Takashi Nakata of Hiroshima University.

- **Memories of the Future: The Uncertain Art of Earthquake Forecasting:** An analysis of the Iben Browning prediction of an earthquake at New Madrid, Missouri was done by William Spence of the USGS. Several of California's "earthquake sensitives" were interviewed by Clarke (1996). The Brady prediction for Lima, Peru, was the subject of a book by Olson (1989). Ma et al. (1990) discussed earthquake prediction in China; an evaluation of these predictions is provided by Bolt (2004), among others. Ren Junjie and Xu Xiwei of the China Earthquake Administration added insights to the earthquakes of Shanxi and Shaanxi counties, including information about cliff dwellings (yaodongs) that collapsed in the earthquake of 1556, resulting in the greatest losses of life in any

earthquake in history. The pros and cons of the VAN method of earthquake prediction were reviewed by Seiya Uyeda (pro) and Dave Jackson and Yan Kagan (con) (1998) in the *Transactions of the American Geophysical Union*, with references to earlier work. The controversy over our ever being able to predict earthquakes has been presented by Robert Geller, Chris Scholz, and Lowell Whiteside, among others. Probabilistic and deterministic forecasting was based on Clarence Allen's chapter in Yeats et al. (1997). C. Allin Cornell, Art Frankel, Tom Hanks, Ellis Krinitzky, David Boore, Robin McGuire, and the late Bill Joyner have contributed much to this field. A good general reference is Reiter (1990). An unpublished report that helped me was "Probabilistic Seismic Hazard Analysis: A Beginner's Guide," by Tom Hanks and Allin Cornell. The emerging field of stress triggering of earthquakes has benefited from the work of Ruth Harris, Bob Simpson, and Bill Ellsworth of the USGS, Steve Jaumé of the College of Charleston and Lynn Sykes of Columbia University, Dave Bowman of California State University at Fullerton, and Geoff King of Institut de Physique du Globe de Paris, in addition to Ross Stein, cited in the chapter. The possibility of earthquake forecasting using both long- and short-term precursors was explained to me by Mike Kozuch of the New Zealand Institute of Geological and Nuclear Sciences, who shared a

house with me in Wellington in 1999. An earlier version of the chapter was reviewed by Clarence Allen, Bill Ellsworth, and Tom Hanks.

- **Solid Rocks and Bowls of Jello:** My understanding of liquefaction and lateral spreading is largely based on the work of Obermeier (1996) of the USGS. Earthquake-induced landslides have been described by Keefer (1984) and Jibson (1996). Articles in the *Seattle Times* were the source of the description of landslides during the Nisqually Earthquake. The chapter in the first edition was reviewed by Eldon Gath and Steve Obermeier.
- **Tsunami!** I learned much from Lori Dengler and the publications of Satake (1992) and Bernard et al. (1991). Harry Yeh and Dan Cox of Oregon State University have advised me on tsunamis, based on their research in the Hinsdale Tsunami Research Lab at OSU. The submarine landslides generating tsunamis accompanying the 1964 Alaska Earthquake were described by Hampton et al. (1993). The effect of the tsunami in Seward and Valdez, Alaska, is based on the account by Nance (1988). I used the archives of the *Seattle Times* to follow the 1964 tsunami down the coast of Vancouver Island, Washington, and Oregon, supplemented by work by John Clague. The book by Griffin (1984) presents the story of the tsunami at Crescent City in the words of those who survived it. The 1960 tsunami is discussed in Atwater et al. (1999). George Priest of DOGAMI

provided information about the Oregon tsunami hazard mitigation program. Information about tsunami hazard mitigation was obtained from the NOAA web site and from Lori Dengler, who has been active in tsunami mitigation in California. An earlier version of the chapter was reviewed by Hal Mofjeld and Frank Gonzalez of NOAA, Lori Dengler of Humboldt State University, and Kenji Satake, now of the University of Tokyo. The section on seiches benefited greatly from the advice of Aggeliki Barberopoulou, now of the University of Southern California, Ed Waddington of the University of Washington, and Hal Mofjeld of NOAA.

- **Earthquake Insurance: Betting Against Earthquakes:** The Western States Seismic Policy Council publication on the Earthquake Insurance Summit was very useful, as was a conference in 1996 sponsored by the Southern California Earthquake Center. I used information from a California Dept. of Conservation publication (1990), and an insurance-industry perspective of political issues involving earthquake insurance was provided by a publication by the Insurance Services Office (1996). The story of the CEA was ably told from the Department of Insurance perspective by Richard J. Roth, Jr., and from the consumer's perspective by the United Policyholders' publication, *What's UP*. The CEA's viewpoint was given by Mark Leonard. The

relationship between damage to homes by the Northridge Earthquake and the age of construction was worked out by Richard Roth, Jr. I learned about the New Zealand earthquake insurance story from David Middleton of the New Zealand Earthquake Commission; Kelvin Berryman of the New Zealand Institute of Geological and Nuclear Sciences explained the effect of the Christchurch earthquakes on insurance rates. The chapter was reviewed by Jack Watts of State Farm Insurance Co., Richard Roth, Jr. of the State Dept. of Insurance, Amy Bach of United Policyholders, Joan Scofield of the Washington State Insurance Commissioner's office, and David Middleton of the New Zealand Earthquake Commission.

- **Is Your Home Ready for an Earthquake?** I began with *Sunset Magazine's* two-part series on earthquake protection, published in 1990 after the Loma Prieta Earthquake. Other useful references are Lafferty and Associates (1989), a booklet by the California Seismic Safety Commission (1992), and publications by the Office of Emergency Services. For wood stoves and propane tanks, I used information from "Living on Shaky Ground," by the Humboldt Earthquake Information Center. Roger Faris, who conducted classes in seismic retrofits of Seattle homes, was an important resource, as was Inés Pearce of the City of Seattle.
- **Earthquake Design of Large Structures:** I received much information from Tom Miller, a structural

engineer at Oregon State University, who provided me with the information from AIA/ACSA Council on Architectural Research. Bolt (2004) was also useful. Yousef Bozorgnia was first author of a publication on advances in earthquake engineering that is in press.

- **The Federal Government and Earthquakes:** Geschwind (2001) and Bob Wallace's oral history (Scott, 1999) presented the background to the establishment of NEHRP, and the early days of NEHRP legislation and presidential declarations are detailed in the report by the Office of Technology Assessment (1995), for which I was an advisor. Reports by Hanks (1985) and Page et al. (1992) provide insights into the USGS role in NEHRP. Examples of how the USGS responded to a major earthquake are provided by Plafker and Galloway (1989) and USGS (1996). The early history of the Pacific Northwest Seismograph Network benefited from an unpublished history of the Department of Geological Sciences at the University of Washington by the late Julian D. Barksdale and additional insights by Robert Crosson and Ruth Ludwin. The history of the Canadian program is based on a summary by Cassidy et al. (2003). The chapter in the first edition was reviewed by Robert Hamilton, who was there for much of the beginning of NEHRP. An earlier version of this chapter was reviewed by Ian MacGregor of NSF and Craig Weaver of USGS.



Mark Stevens of FEMA reviewed parts of the chapter.

- **The Role of State and Local Government:** For the Division of Mines and Geology, now the California Geological Survey, the memoirs of Olaf Jenkins (1976) and Gordon Oakeshott (1989) were useful as well as the account by Geschwind (2001). Bill Bryant and Bob Sydnor also provided me information. Geschwind was also the best source for the legislative history of state involvement in earthquake preparedness, starting with the 1933 earthquake and continuing through the establishment of Alquist-Priolo and other legislative acts. Web sites for OES and the Seismic Safety Commission were very useful. Problems with the Alquist-Priolo Act were described in a series in the Los Angeles Times by Rong-Gong Lin and his colleagues and conversations with Eldon Gath of Earth Consultants International in their discussions about two developments in Hollywood. I also benefited from discussions with John Parrish, California state geologist, and Lucile Jones of USGS, who spent a year in the office of the Mayor of Los Angeles advising him about making his city resilient against large earthquakes, including a magnitude 7.8 earthquake on the southern San Andreas fault. I received a lot of help in understanding building codes from Walter Friday of Linhart Petersen Powers Associates. Diane Murbach of the City of San Diego was a

great help in getting me information about California grading ordinances. Tim Walsh, Karl Wegmann, and Pat Pringle of the Washington Division of Geology and Earth Resources provided information about the Growth Management Act and Washington's response to earthquakes. Inés Pearce of the City of Seattle and JoAnn Jordan of the City of Bellevue provided information about earthquake programs in those cities. The chapter in the first edition was reviewed by Eldon Gath of Earth Consultants International, who has worked under California regulations for his entire career; and Earl Hart of the Division of Mines and Geology, who was involved in carrying out the provisions of the Alquist-Priolo Act almost from the beginning. Bill Steele of the University of Washington introduced me to many people in Washington who have been responsible for the success of the earthquake program there, in addition to providing his own insights.

- **Preparing for the Next Earthquake:** See references for Chapter 12. Publications arising from Seattle's Project Impact were very useful.
- **An Uncertain Appointment with a Restless Earth: The Cost of Doing Nothing.** The summary by CREW and the resilience surveys done by the states of Oregon and Washington formed the basis of this chapter. I learned about the resiliency surveys from Ian Madin, chief scientist of the Dept. of Geology and Mineral Industries.

- **Appendix A. Table of Significant Earthquakes in the Pacific Northwest.** Compilations for California by Bill Bakun, Lori Dengler, Bill Ellsworth, Ruth Ludwin, and Tousson Topozada, and the table of earthquakes with surface rupture from Yeats et al. (1997), were used to prepare this table. I learned about earthquakes in Canada from John Cassidy of the PGC and earthquakes on the Blanco Fracture Zone from Bob Dziak of NOAA.

# Appendix D: Sources of Information and Websites

Advanced National Seismic System Web site:  
[www.anss.org/](http://www.anss.org/)

Alaska Tsunami Warning Center, 910 S. Felton Street,  
Palmer, AK99645. 907-745-4212. Web site:  
<http://wcatwc.arh.noaa.gov>

A. M. Best, the standard insurance company rating  
system. Web site: [www.ambest.com](http://www.ambest.com)

American Red Cross, 2700 Wilshire Boulevard, Los  
Angeles, CA 90057, 213-739-5200; 550 Sutter St., San  
Francisco, CA 94109, 415-202-0780.

Association of Engineering Geologists Web site:  
[www.aegweb.org](http://www.aegweb.org)

Build your own seismograph: [cea-ftp.cea.berkeley.edu/~edsci/lessons/indiv/daris/hs/seismograph](http://cea-ftp.cea.berkeley.edu/~edsci/lessons/indiv/daris/hs/seismograph)

California Department of Insurance Web site:  
[www.insurance.ca.gov](http://www.insurance.ca.gov)

California Geological Survey, P.O. Box 2980,  
Sacramento, CA 95812-2980; 107 S. Broadway, Los  
Angeles, CA 90012, 213-620-3560; 185 Ferry St., San  
Francisco, CA 94107-1725, 415-904-7707.  
916-445-5716; [www.consrv.ca.gov/cgs](http://www.consrv.ca.gov/cgs)

California Governor's Office of Emergency Services,  
11200 Lexington Drive, Bldg. 283, Los Alamitos, CA  
90720-5002. 310-795-2900. Web site:

[www.caloes.ca.gov](http://www.caloes.ca.gov)

California Seismic Safety Commission:

[www.seismic.ca.gov](http://www.seismic.ca.gov)

Canadian Centre for Emergency Preparedness. Web  
site: [www.ccep.ca](http://www.ccep.ca)

Canadian RADARSAT. [Ahmed.Mahmood@space.gc.ca](mailto:Ahmed.Mahmood@space.gc.ca);

Web site for remote sensing: [www.ccrs.nrcan.gc.ca](http://www.ccrs.nrcan.gc.ca)

Cascade Volcano Observatory: [volcanoes.usgs.gov/  
observatories/cvo](http://volcanoes.usgs.gov/observatories/cvo)

Cascadia Regional Earthquake Workgroup. Web site:

[www.crew.org](http://www.crew.org)

Community Internet Intensity Maps (Did You Feel It?):

[earthquake.usgs.gov/data/dyfi](http://earthquake.usgs.gov/data/dyfi)

Consortium of Universities for Research in Earthquake  
Engineering, 1301 S.46th St., Richmond, CA 94804.

510-231-9557. Web site: [www.curee.org](http://www.curee.org)

Earthquake Engineering Research Institute, 499 14th  
Street, Suite 320, Oakland, CA 94612-1934.

610-451-0905. Web site: <http://www.eeri.org>; e-mail:

[eeri@eeri.org](mailto:eeri@eeri.org)

Earth Sciences Animated, Jenda Johnson,  
[jendaj@comcast.net](mailto:jendaj@comcast.net), 503-281-1814 (Portland, OR)

(Videos include those in this book and those in IRIS  
powerpoint presentations on recent earthquakes,  
together with Bob Butler of University of Portland.

EarthScope education and outreach. Web site:

<http://dax.geo.arizona.edu/earthscope/eo/>

Educational computer programs for seismology:  
<http://www.geol.binghamton.edu/faculty/Jones>

Federal Emergency Management Agency, P.O. Box 70274, Washington, DC 20024; The Presidio, Bldg. 105, San Francisco, CA 94129, 415-923-7100; 245 South Los Robles, Pasadena, CA 91101, 818-451-3000. Web site: [www.fema.gov](http://www.fema.gov); HAZUS Web site: [www.hazus.org](http://www.hazus.org)

Humboldt Earthquake Education Center, Department of Geology, Humboldt State University, Arcata, CA 95521-8299. 707-826-3931. Web site: [http://sorrel.humboldt.edu/~geodept/earthquakes/eqk\\_info.html](http://sorrel.humboldt.edu/~geodept/earthquakes/eqk_info.html)

Incorporated Research Institutions in Seismology (IRIS), 1200 NW New York Avenue, Washington, DC 20005. Web site: [www.iris.washington.edu](http://www.iris.washington.edu). Monitor earthquakes around the world in near-real time, visit worldwide seismic stations. Earthquakes of M 6 or larger are linked to special information pages that explain the where, how, and why of each earthquake. Web site: [www.iris.edu](http://www.iris.edu). Earthquake-related animations created by Jenda Johnson and Robert Butler and identified in this book are used courtesy of the IRIS Consortium.

Institute for Business and Home Safety. Web site: [www.ibhs.org](http://www.ibhs.org)

Insurance Institute for Property Loss Reduction. E-mail: [iiplr@aol.com](mailto:iiplr@aol.com)

International Conference of Building Officials. Web site: [www.icbo.org](http://www.icbo.org) (latest information on building codes)

International Tsunami Information Center, Box 50027,  
Honolulu, HI 96850-4993. 808-541-1658.

Multidisciplinary Center for Earthquake Engineering  
Research, State University of New York at Buffalo,  
Red Jacket Quadrangle, Buffalo, NY 14261.  
716-645-3391 Web site: [http://mceer.buffalo.edu/  
outreach/](http://mceer.buffalo.edu/outreach/)

National Aeronautics and Space Administration. Web  
site: [observe.arc.nasa.gov](http://observe.arc.nasa.gov)

National Earthquake Information Center. Web site:  
<http://neic.usgs.gov>; e-mail: [neic@usgs.gov](mailto:neic@usgs.gov)

National Geophysical Data Center (NOAA), 325  
Broadway, Boulder, CO 80303. 303-497-6215. Web  
site: [www.ngdc.noaa.gov/ngdc.html](http://www.ngdc.noaa.gov/ngdc.html)

National Institute of Building Sciences, 1201 L Street  
NW, Suite 400, Washington, DC 20005-4024.  
202-289-7800.

National Landslide Information Center. E-mail:  
[nlc@usgs.gov](mailto:nlc@usgs.gov)

National Oceanic and Atmospheric Administration,  
National Tsunami Hazard Mitigation Program. Web  
site: <http://www.pmel.noaa.gov/tsunami-hazard/>

National Science Foundation. Web site: [www.nsf.gov](http://www.nsf.gov)

Nature of the Northwest Information Center, 800 NE  
Oregon Street #5, Suite 177, Portland, OR 97232.  
503-872-2750.

Northern California Earthquake Data Center. Web site:  
[quake.geo.berkeley.edu](http://quake.geo.berkeley.edu)

Oregon Department of Geology and Mineral Industries,  
800 NE Oregon St. #28, Suite 965, Portland, OR

97232. 503-872-2750. Web site:  
[www.oregongeology.com](http://www.oregongeology.com)

Oregon Emergency Management. Web site:  
[www.usp.state.or.us/oem/index.htm](http://www.usp.state.or.us/oem/index.htm)

Oregon Natural Hazards Workgroup. E-mail:  
[onhw@uoregon.edu](mailto:onhw@uoregon.edu); Web site:  
<http://darkwing.uoregon.edu/~onhw>

Pacific Disaster Center (tsunami warnings). Web site:  
[www.pdc.org](http://www.pdc.org)

Pacific Earthquake Engineering Research Center,  
University of California, 1301 S. 46th Street,  
Richmond, CA 94804-4698. 510-231-9554. Web site:  
<http://peer.berkeley.edu>; e-mail:  
[eerclub@nisee.ca.berkeley.edu](mailto:eerclub@nisee.ca.berkeley.edu)

Pacific Northwest Seismograph Network. Web site:  
[www.geophys.washington.edu](http://www.geophys.washington.edu); click on Pacific NW  
Earthquakes

Pacific Tsunami Warning Center, 91-270 Fort Weaver  
Road, Ewa Beach, HI 96706-2928. 808-689-8207. Web  
site: [www.prh.noaa.gov/ptwc](http://www.prh.noaa.gov/ptwc)

Seattle Division of Emergency Management. Web site:  
[www.cityofseattle.net](http://www.cityofseattle.net)

Seattle Area Home Retrofits: Roger Faris, email:  
[roger@phinney/center.org](mailto:roger@phinney/center.org)

Seismic Safety Commission, 1755 Creekside Oaks Drive,  
Suite 100, Sacramento, CA 95833. 916-263-5506. Web  
site: [www.seismic.ca.gov](http://www.seismic.ca.gov)

Seismological Society of America, Suite 201, Plaza  
Professional Building, El Cerrito, CA 94530-4003.  
Web site: [www.seismosoc.org](http://www.seismosoc.org)



Seismosurfing. Web site:  
[www.geophys.washington.edu/seismosurfing.html](http://www.geophys.washington.edu/seismosurfing.html)

ShakeMap (available 10 minutes after earthquake). Web site: <http://earthquake.usgs.gov/shakemap/>

Southern California Earthquake Center (SCEC), University of Southern California, University Park, Los Angeles, CA 90089-0742. Web site: [www.scec.org](http://www.scec.org); Earthquake data center: [www.data.scec.org](http://www.data.scec.org). Information on recent earthquakes in California, with maps: [www.scecdc.scec.org/recenteqs](http://www.scecdc.scec.org/recenteqs) and [www.scecdc.scec.org/earthquakes/current.txt](http://www.scecdc.scec.org/earthquakes/current.txt)

(text). Weekly coverage of earthquake news at <http://www.scec.org/instanet>. Mark Benthien of SCEC organized the Great California ShakeOut as a public exercise in responding to a magnitude 7.8 earthquake on a part of the San Andreas fault that has not had an earthquake in more than 300 years. This exercise has been adopted around the world, including the Pacific Northwest.

Southern California Integrated GPS Network (SCIGN). Web site designed as a learning module: <http://scign.jpl.nasa.gov/learn/>

United Policyholders, 110 Pacific Ave. #262, San Francisco, CA 94111. Web site: [www.unitedpolicyholders.org](http://www.unitedpolicyholders.org). e-mail [info@unitedpolicyholders.org](mailto:info@unitedpolicyholders.org).

U.S. Geological Survey, Earth Science Information Center, 345 Middlefield Road, Menlo Park, CA 94025. 415-329-4390. Web site: [www.usgs.gov](http://www.usgs.gov); earthquake

information Web site (Menlo Park, CA): [earthquakes.usgs.gov](http://earthquakes.usgs.gov) includes an earthquake education Web site entitled “Earthquakes for Kids & Grownups,” [earthquakes.usgs.gov/4kids/](http://earthquakes.usgs.gov/4kids/) Questions addressed to [walrus.wr.usgs.gov/docs/ask-a-ge](mailto:walrus.wr.usgs.gov/docs/ask-a-ge) will be answered by a geologist.

Washington Division of Geology and Earth Resources.

Web site: [www.dnr.wa.gov](http://www.dnr.wa.gov)

Washington Emergency Management Division. Web

site: [www.wa.gov/wsem](http://www.wa.gov/wsem)

Western States Seismic Policy Council, 121 Second Street, 4th Floor, San Francisco, CA 94105. Web site:

[www.wsspc.org](http://www.wsspc.org) For online discussion group e-mail:

[wsspc@wsspc.org](mailto:wsspc@wsspc.org); Web site: [www.wsspc.org](http://www.wsspc.org)

# About the Author

Robert Yeats is a Fellow of the American Association for the Advancement of Science and the Geological Society of America. He is senior consultant and partner in Earth Consultants International, an international firm focusing on earthquake hazards, and also an Emeritus Professor at Oregon State University, where an endowed professorship has been named in his honor. He has decades of experience in earthquake geology worldwide, including acting as chair of an active fault working group of the International Lithosphere Program for several years and writing four previous books: *Geology of Earthquakes* (with Kerry Sieh and Clarence R. Allen; Oxford University Press), *Living with Earthquakes in California*, *Living with Earthquakes in the Pacific Northwest* (first and second editions; OSU Press), and *Active Faults of the World* (Cambridge University Press). A fifth book, *Earthquake Time Bombs*, will be published in 2015 by Cambridge University Press.

# Index

## A

Abella, Sally

acceleration: peak horizontal acceleration; strong-motion instrument

accretionary wedge

Adams, John

Adel, Oregon, Earthquakes of 1968

aftershocks; aftershock or foreshock? *See also* foreshock

Alaska, Gulf of, Earthquake of 1964; liquefaction accompanying; tectonic subsidence; tsunami accompanying, *see* tsunami

Allen, Clarence

Allen, Richard

anticline

Archuleta, Ralph

asteroid impact probability

asthenosphere

Astoria Submarine Canyon and Channel

Atwater, Brian

## B

Bakun, Bill

Barberopoulou, Aggeliki

basalt. *See also* Columbia River Basalt

base isolation

Basin and Range

Beeson, Marvin

Bellevue, Washington, earthquake program

benchmark, survey

Bend, Oregon, faults

Benioff zone earthquakes. *See* slab earthquakes

Bentley, Bob

Blakely, Rick

Blanco Fracture Zone

Bonneville Landslide

Bourgeois, Joanne

Bradley Lake, Oregon

Brady, Brian

bridges, damage to

British Columbia earthquake programs

brittle-ductile transition

brittle fracture

brittle structures

Brocher, Tom

Browning, Iben

Bruer, Wes

Bucknam, Bob

building codes; increased cost for earthquake

strengthening; International Building Code; lives vs. property protection; National Building Code of Canada. *See also* Uniform Building Code; California building codes; Oregon Structural Specialty Code buried forests and marshes. *See* Cascadia Subduction Zone

Burns, Scott

buttress

## C

California Alquist-Priolo Act

California building codes. *See also* building codes

California Geological Survey (formerly Division of Mines and Geology); Strong Motion Instrumentation Program

California Earthquake Hazard Reduction Program

California Earthquake Authority

California Office of Emergency Services: Disaster Office; California Seismic Safety Commission

California Seismic Mapping Act

Caltrans

Campbell, Newell

Canadian government-sponsored earthquake research. *See also* Geological Survey of Canada; Pacific Geoscience Centre

Cape Mendocino Earthquake of 1992. *See* Petrolia Earthquake

Carson, Bob  
Carver, Deborah  
Carver, Gary  
Cascade volcanoes  
Cascadia deep-sea channel  
Cascadia Earthquake of A.D. 1700; tsunami  
Cascadia earthquakes, pre-A.D. 1700  
Cascadia Region Earthquake Workgroup  
Cascadia Subduction Zone; acceleration due to earthquake on, 195-97, 216; deterministic forecast on; eastward-convex arch; insurance against, 234; marsh evidence for earthquakes; probabilistic forecast on  
Central Nevada Seismic Zone  
Chelan, Washington, Earthquake of 1951  
Chi-Chi, Taiwan, Earthquake of 1999  
Chile Earthquake of 1960; tsunami in Japan  
chimney damage  
China, earthquake predictions  
Coalinga Earthquake of 1983  
Coast Range  
Cocos Plate  
Columbia River Basalt  
Community Internet Intensity Map  
connection failure  
Continental shelf  
Coos Bay, Oregon, buried marshes  
Copalis River, Olympic Peninsula  
Coppersmith, Kevin  
Corvallis Fault  
COSMOS

Creager, Ken

Crescent City, California, tsunami of 1964

cripple wall

critical facility

Crosson, Robert

crust of the Earth; continental crust; oceanic crust;

brittle crust; ductile crust

## D

Dam, Van Norman

Darrington-Devils Mountain Fault

Deming, Washington, Earthquake of 1990

Denali, Alaska, Earthquake of 2002

design of large structures: base isolation; bridges and

overpasses; special problems

disclosure requirements

Dragert, Herb

duck, cover, and hold

ductile deformation

ductile structures

Duvall, Washington, Earthquake of 1996



## E

earthquake hazard maps; in California; of Oregon cities;  
of Seattle and Olympia; of Victoria, BC

earthquakes: characteristic; cluster; control of; drills;  
education; implementation and outreach; interaction  
among faults; loss of market share due to; media  
response to; precursors; preparedness for;  
recurrence of; resistance to, for large buildings; slow  
earthquakes;

earthquake engineering; engineering geologist;  
Earthquake Engineering Research Institute;  
performance-based

East Pacific Rise

elasticity; elastic deformation; elastic rebound

Ellsworth, Bill

epicenter

excavations across faults

Explorer Plate; earthquakes in

Explorer Ridge

## F

Fairweather, Alaska, Earthquake and landslide of 1958

Farallon Plate

Faris, Roger

fault: blind; dip-slip; displacement; fault-plane solution;

fault map of Oregon; normal; reverse; strike-slip; surface rupture; thrust; transform. *See also* slip rate on faults

Federal Response Plan

FEMA. *See* U.S. Federal Emergency Management Agency

Filson, John

floods of 1996

focus; focal depth

footwall

forecasting, earthquake; deterministic; probabilistic; probability forecast for San Francisco Bay region; time of increased [earthquake] probability

foreshock

foundation, bolting to

fracture zones

Fraser River Delta

## G

Geller, Robert

geodesy

geologic time

Geological Survey of Canada

geotechnical engineering

glacial ice caps; lowered sea level because of

Global Positioning System (GPS); Pacific Northwest

Geodetic Array (PANGA); Western Canada  
Deformation Array  
Goldfinger, Chris  
Gorda Plate; earthquakes in  
Gorda Ridge  
Gower, Howard  
grading ordinances. *See also* Uniform Building Code  
granite  
Grant, Wendy  
Greece, earthquake prediction  
Griffin, Wally  
Griggs, Gary  
ground displacement, engineering against  
Gulf of California spreading center  
Gutenberg-Richter relationship; for Puget Sound-  
Georgia Strait region

## H

Hanford Nuclear Reservation; Basalt Waste Isolation  
Project  
hanging wall  
Harris, Ruth  
hazard; vs. peril; vs. risk  
Heaton, Tom  
Hebgen Lake, Montana, Earthquake and landslide of  
1959  
Heceta Bank, Oregon

Hemphill-Haley, Eileen  
Hemphill-Haley, Mark  
highway leveling  
Holocene  
home retrofit against earthquakes; preparedness  
Hope, B.C., landslide of 1965  
hospitals, damage to  
Humboldt Bay, California  
Hull, Don  
Hurricanes: Andrew; Isabel  
hydrophone arrays. *See* T-phase waves  
Hyndman, Roy  
hypocenter. *See* focus

## I

Incorporated Research Institutions for Seismology  
Indian Earthquake of 1897  
Indians. *See* Native Americans  
inertia  
Institute of Building and Home Safety  
insurance, earthquake; adverse selection; capacity;  
catastrophic; claims; computer models; cost-based;  
deductible; government intervention; homeowners'  
insurance; indemnity; liability; Natural Disaster  
Coalition; premium; probable maximum loss; proof of  
loss; reinsurance; reserves; risk; state department of  
insurance; surplus; underwriting

intensity; intensity scale  
inventory, home

## J

Jackson, Dave  
Jacoby, Gordon  
Jahns, Richard  
Japan: civilization; government-sponsored earthquake  
research; tsunamis  
Jibson, Randy  
Johnson, Sam  
Juan de Fuca Plate  
Juan de Fuca Ridge  
Juan de Fuca submarine canyon

## K

Kagan, Yan  
Kanamori, Hiroo  
Karlin, Bob  
Keefer, David  
Keilis-Borok, V. I.  
Kelsey, Harvey  
Klamath Falls, Oregon, Earthquakes of 1993: landslides  
and rockfalls

Kobe, Japan, Earthquake of 1995  
Krakatau, Indonesia, eruption and tsunami of 1883  
Kulm, LaVerne

## L

Lake Washington: trees beneath, 110, 111; sediment cores in, 112, 115  
Landers, California, Earthquake of 1992, 56-57, 178-79  
landslides, 110-12, 189, 191, 205-12, 246, 326, 343, 346, 350; induced by heavy rains, 211, 343; submarine, 63, 208, 209, 234. *See also* rockslides  
lateral spread, 200-201, 203, 213, 343  
Law of Large Numbers, 242, 245, 251. *See also* insurance  
Liberty, Lee, 125  
LiDAR mapping, 119, 120, 325  
Lima, Peru, Earthquake of 1981, prediction, 159-60  
Lindh, Allan, 180-81  
liquefaction, 68, 125, 188, 190-91, 198-205, 212-13, 246, 268, 326, 343, 346, 350  
lithosphere, 15, 20-21  
Little Salmon Fault, 83, 150  
loads, 261-62  
Loma Prieta Earthquake, vii, 179, 181, 191-92, 201-2, 237, 245, 250, 267; attempts to forecast, 179-81; foreshocks, 181; liquefaction accompanying, 201, 202, 205

Long Beach, California, Earthquake of 1933, 294, 297,  
321, 336, 348

Los Angeles Basin, 196-97

Ludwin, Ruth, 51, 118

## M

Macelwane, James, 167

Mad River Fault, 83, 150

Madin, Ian, 124-25

magnitude, 42-43, 59; intensity magnitude, 51; moment  
magnitude, 44; surface-wave magnitude, 44. *See also*  
Richter magnitude

magnitude 8 vs. 9 at Cascadia, 72-77, 80, 82-83, 168-69,  
175, 243

Malone, Steve, 128

Mantle, 15, 19-20, 22, 41

manufactured homes, 276, 277-78

maps: of earthquake hazard, *see* earthquake hazard  
maps; of tsunami hazard, *see* tsunami

marine platform. *See* wave-cut platform

masonry grades, 46-47. *See also* unreinforced masonry

maximum considered (credible) earthquake, 168-70, 172

Mazzotti, Stephan, 121

McCrorry, Pat, 146

McKay, Mary, 62

McNeill, Lisa, 146

Mendocino Fracture Zone, 17, 23, 24, 26, 71, 83, 93, 94-95, 149; earthquakes in, 95-96; triple junction, 24-25, 26

Merten, Diane, 359-60

Mexico City Earthquake: of 1978, 361-62; of 1985, 193, 289

Mid-Atlantic Ridge, 16, 21, 24

Miller, Meghan, 57-58, 88

Milton-Freewater, Oregon, Earthquake of 1936, 133-34, 152

Minor, Rick, 67, 72, 82

Missoula floods, 10, 64, 123-25

Mitchell, Clifton, 75-76

mitigation, 300

mobile homes. *See* manufactured homes

Modoc Point, Oregon, rockfall, 138, 139

Mt. Mazama eruption and ash, 10, 64-66, 82, 86, 112-13

Mt. Rainier: mudflows, 119, 122; seismic zone, 122

Mt. St. Helens, 10, 14, 69, 122, 156; network, 313; rock avalanche and mudflow, 122, 208; seismic zone, 122-23, 125

Moho discontinuity, 15, 19, 20, 22

Mohorovičić, Andrija, 19

Mount Angel Fault, 125, 127-28, 152

## N

Nábeřlek, John, 128



Nankai, Japan, Subduction Zone, 75-77, 85, 162; Tokai prediction experiment, 162-63

NASA. *See* U.S. National Aeronautics and Space Administration

National Earthquake Prediction Evaluation Council, 157, 160, 180

National Fire Protection Association (NFPA 5000), 337

National Institute of Building Sciences, 305

National Science Foundation. *See* U.S. National Science Foundation

Native Americans, 10, 81-82, 89, 121, 334-35; Bridge of the Gods legend, 210-11; buried campsite, 72; Seattle Fault stories, 118

NAVSTAR satellites. *See* Global Positioning System

neighborhood plan, 334, 353-54

Nelson, Alan, 79, 81, 169

Nelson, Hans, 64-66

Neumann, Frank, 313

Newell, Chuck, 126

New Madrid, Missouri, Earthquake of 1990, prediction, 157

New Zealand: Earthquake Commission, 254; earthquake insurance, 254-55

Nisqually Earthquake of 2001, 47, 49-50

NOAA. *See* U.S. National Oceanic and Atmospheric Administration

Nootka Fracture Zone, 23, 96, 106, 131

North America Plate, 16, 20-21, 24, 26, 27, 30, 93, 109

North Anatolian Fault, Turkey, 178

North Cascades Earthquake of 1872, 51, 131-33, 152

Northridge Earthquake of 1994, vii, 35-36, 47, 56, 108, 117, 159, 188-89, 237, 242, 245-46, 248, 250-51, 253; media coverage of, 317

Nuclear test-ban compliance, 297-98

## O

Obermeier, Steve, 120, 201, 203-4

Olsen, Kim, 196-97

Olympic Mountains, 64, 70, 104

Olympic-Wallowa Lineament, 133-34, 135, 138, 152

Oregon Academy of Sciences, 3, 64, 72

Oregon-California Border Earthquake of 1873, 103

Oregon Department of Geology and Mineral Industries, 237, 325, 331, 340

Oregon Department of Transportation, 289, 344

Oregon Office of Emergency Management, 328-31

Oregon Natural Hazards Workgroup, 345-46

Oregon Seismic Safety Policy Advisory Commission, 330, 332

Oregon State University baccalaureate core curriculum, vii-viii

Oregon Structural Specialty Code, 336-37

Oroville, California, Earthquake of 1975, 299

Othello, Washington, earthquake swarm of 1987, 133

Owens Valley, California, Earthquake of 1872, 320-21

## P

- Pacific Geoscience Centre, 76, 87-88, 106, 109, 121, 131, 171-72, 314-15
- Pacific Northwest Seismograph Network, 47-48, 306, 312-14, 344
- Pacific Plate, 16-17, 21, 24, 26, 27, 30, 93
- paleoseismology, 36-38, 59, 66, 89, 143, 162, 170, 174-75, 178, 182, 315
- Palmdale Bulge, 299-300
- PANGA. See Global Positioning System
- Parkfield, California, forecast, 160-63, 173-78, 185, 357
- Pasco Basin, Washington, 41, 135-38
- Personius, Stephen, 169
- Peru Earthquake and landslide of 1970, 189, 205, 208, 212
- Peterson, Curt, 204
- Petrolia, California, Earthquake of 1992, 84, 85, 93-94, 150, 234-35, 253
- Pezzopane, Silvio, 143
- Plafker, George, 3, 53
- plate tectonics, 5, 9-10, 14-27, 54, 298, 303
- Pleasant Valley, Nevada, Earthquake of 1915, 33
- Pleistocene Epoch, 11-12, 63-64, 112, 123, 147, 203-4. See *also* glacial ice caps
- Portland, Oregon, earthquakes of 1877 and 1962, 125-26
- Portland Hills Fault, 123, 124, 125, 152, 185, 347, 355
- Pratt, Tom, 125
- prediction, earthquake, 156-60, 164-67, 186, 299-301
- Presidential Major Disaster Declaration, 303-4, 330

Preston, Leiph, 105

Priest, George, 331

Pringle, Pat, 210

probability curve. *See* forecasting

psychological issues with earthquakes, 359

Puget Sound slab earthquakes, 202, 280; of 1939, 97, 107; of 1946, 97, 107; of 1949, 8, 43, 97-99, 107, 115-17, 169, 203, 279, 295, 313; of 1965, 8, 99-100, 203; lack of aftershocks, 107; landslides accompanying, 205, 206. *See also* Nisqually Earthquake, Satsop Earthquake

## Q

Queen Charlotte Fault, 16, 27

## R

radar interferometry, 57

radiocarbon dating, 12-13, 37-38, 73, 113, 115, 151, 203-4;  
reservoir correction, 13

Rasmussen, Norm, 313

Red Cross, 304

red-tagged and yellow-tagged buildings, 343, 353

Redwood Coast Earthquake Study Group, 345

Reid, Harry, 30-31, 52-54, 179, 181, 296

resonance (tuning fork) problem, 287-89

retrofit, 254, 263-64, 280-82, 292-94, 304, 355, 363; of historic buildings, 281-82, 286-87

Richter, Charles, 42-43, 156, 296: Richter magnitude scale, 43-44

risk. *See* hazard, insurance

Rivera Plate, 25, 26, 27

rock site, 192-93, 198

rockslides, earthquake-induced, 189, 206-9: Olympic Peninsula, 114, 115, 117, 206-7; Ribbon Cliffs, Washington, 132, 211. *See also* Modoc Point

Rogers, Garry, 81, 87-88, 105, 130

Rogue River Submarine Canyon, 65-66

## S

San Andreas Fault, 9, 10, 16, 22, 23, 24-25, 26, 27, 30-31, 32, 33, 36-37, 52, 54-55, 83, 85, 89, 93-95, 162, 173-75, 178-81, 246, 296, 321; prehistoric earthquakes on, 37; 1857 Fort Tejon Earthquake, 9, 10, 32, 37, 173-74, 253, 357

San Fernando Earthquake of 1971. *See* Sylmar Earthquake

San Francisco Earthquake of 1906, 30, 44-45, 52, 173-74, 179, 191-92, 237-38, 296-97; insurance claims, 242-43, 250

sand dikes, 116, 200, 201, 203, 204; at Centralia, Washington, 120; sand boils and sand blows, 200-201

Santa Barbara, California, Earthquake of 1925, 297, 336

Satake, Kenji, 79-81, 85, 218, 225  
Satsop, Washington, Earthquake of 1999, 100, 339, 355  
Savage, Jim, 2, 53-54, 70, 72  
schools: building codes for, 297, 336, 248; damage to, 97-100, 103, 130, 281, 293-94, 338-39; preparedness plans and retrofits, 333-34, 354-55  
Schuster, Bob, 115, 206-7, 210  
Schwartz, Dave, 174-75  
Scotts Mills, Oregon, Earthquake of 1993, 38, 45, 48, 108, 127, 129-30, 152, 339, 349  
SDART (Seattle) program, 269, 334  
Seattle Fault, 35, 82, 115, 116-19, 169-70, 185, 279, 325: earthquake of A.D. 900-930, 10, 109, 111, 117-18, 120, 206-7, 243; seismic waves focused on, 197; tsunami from, 228  
seiche, 238-39  
seismic gap theory, 162  
seismic safety element of general plan, 323  
seismic sea wave. *See* tsunami  
seismic waves, 38-43; attenuation, 51; P waves, 39, 40, 41, 51, 184, 362; S waves, 39, 40, 41, 362; surface vs. body waves, 39  
seismic zones (for building codes), 336  
seismicity, 89, 92, 95-96, 104, 170, 173-74  
seismograph, 5, 41: Gonzaga College, 296; Wood-Anderson, 40, 43-44  
Seismological Society of America, 297-98  
ShakeMap, 47-48, 50  
shear walls, 265-67, 282-84, 288  
Sherrod, Brian, 120

Sherrod, Dave, 141  
shoreline angle, 145-49, 146  
side-scan sonar, 8, 61, 62  
Simpson, Bob, 178  
Sixes River, Oregon, 71, 86  
slab earthquakes, 38, 96-107, 169: rare aftershocks, 103,  
107  
slip rate on faults, 36-37, 59  
Slosson's Law, 343  
soft story, 266-67, 287-88  
soil site, 192-93  
soils engineer. *See* geotechnical engineering  
SOSUS. *See* T-phase waves  
South American tsunami earthquakes, 79  
Southern California Earthquake Center, 307-8  
Southern Whidbey Island Fault, 119, 173  
South Sister volcano, uplift, 57  
Sovanco Fracture Zone, 23, 92  
space-based geodesy. *See* Global Positioning System  
Spence, William, 159-60  
Spokane, Washington, earthquake swarm of 2001, 133  
spreading centers, 16-17, 27, 34, 92, 96, 109  
Spring Break Quake. *See* Scotts Mills Earthquake  
Standard Penetration Test, 200-201, 209  
state of the art vs. standard of practice, 342-43, 347  
Steens Mountain, Oregon, 34, 142  
Stein, Ross, 178  
Steinbrugge, Karl, 322  
Stonewall Bank, Oregon, anticline, 149  
strain, 29, 38

stress, 42  
strong ground motion, 191-98  
structural engineering. *See* earthquake engineering  
Stuiver, Minze, 12  
subduction zone, 21, 54, 162. *See also* Cascadia Subduction Zone  
submarine canyon, 18, 63, 66, 87  
submarine channel, 63, 82, 85-87, 89  
Sylmar (San Fernando Valley) Earthquake of 1971, 34, 35-36, 54, 158-59, 194  
syncline, 36

## T

T-phase waves  
Tacoma Fault  
tidal wave. *See* tsunami  
Toe Jam Hill Fault  
Toppenish Ridge, Washington  
transform fault  
tree-ring dating  
tsunami: before 1964; CREST; deep-sea pressure gauge; directivity of; effects of sea-floor configuration; hazard maps; in Hawaii; Japanese characters for; logo; long-period waves; National Tsunami Hazard Mitigation Program; of 1964; surfing a; sounds of. *See also* U.S. National Oceanic and Atmospheric Administration



Tualatin Basin  
turbidites

## U

uncertainty principle

Uniform Building Code. *See also* building codes

United Policyholders, Inc.

U.S. Army Corps of Engineers

U.S. Bureau of Reclamation

U.S. Coast and Geodetic Survey. *See* U.S. National Geodetic Survey

U.S. Department of Energy

U.S. Department of Health and Human Services

U.S. Federal Emergency Management Agency (FEMA):  
Disaster Mitigation Act of 2000; Federal Insurance  
Administration; HAZUS; as part of Department of  
Homeland Security; Project Impact

U.S. Geological Survey: Advanced National Seismic  
System; external grants program; Puget Sound-  
Portland program

U.S. National Aeronautics and Space Administration  
(NASA): Jet Propulsion Lab; Earth Systems Enterprise.  
*See also* Global Positioning System

U.S. National Earthquake Hazard Reduction Program

U.S. National Geodetic Survey

U.S. National Geophysical Data Center

U.S. National Institute of Standards and Technology

U.S. National Oceanic and Atmospheric Administration (NOAA): National Undersea Research Program; seafloor mapping; tsunami warning systems

U.S. National Science Foundation: earthquake engineering research centers; Network for Earthquake Engineering Simulation; Ocean Sciences Directorate

U.S. Navy

U.S. Nuclear Regulatory Commission

U.S. Small Business Administration

U.S. Weather Bureau

University of California, Berkeley seismic network

University Navstar Consortium

unreinforced masonry (URM)

utility lines

## V

VAN prediction method

Vancouver Island, earthquake of 1918; earthquake of 1946

Vere-Jones, D.

Very Long Baseline Interferometry

## W

Wang, Kelin  
Washington Department of Transportation  
Washington Division of Geology and Earth Resources  
Washington Growth Management Act  
Washington State Emergency Management Division  
water heater, strapping  
wave amplitude: frequency; period; wavelength  
wave-cut platform  
Wecoma Fault  
Weldon, Ray  
Wentworth, Carl  
Werner, Ken  
West Point, Seattle, trench  
Western Canada Deformation Array. See Global Positioning System  
Western States Seismic Policy Council  
Whitcomb, Jim  
Willapa Bay, Niawiakum Estuary of: active syncline  
Wilson, Joseph  
Wong, Ivan  
Woodburn, Oregon, earthquake swarm of 1990  
Working Group on California Earthquake Probabilities  
WWSSN

# X

# Y

Yakima Fold Belt

Yamaguchi, Dave

Yount, Jim

# Z

# Creative Commons License

This work is licensed by Robert S. Yeats under a [Creative Commons Attribution-NonCommercial 4.0 International License](#) (CC BY-NC)

You are free to:

**Share** – copy and redistribute the material in any medium or format

**Adapt** – remix, transform, and build upon the material

The licensor cannot revoke these freedoms as long as you follow the license terms.

**Under the following terms:**

**Attribution** – You must give appropriate credit, provide a link to the license, and indicate if changes were made. You may do so in any reasonable manner, but not in any way that suggests the licensor endorses you or your use.

**NonCommercial** – You may not use the material for commercial purposes.

**No additional restrictions** – You may not apply legal terms or [technological measures](#) that legally restrict others from doing anything the license permits.

# Recommended Citations

## APA outline:

Source from website:

- (Full last name, first initial of first name). (Date of publication). Title of source. Retrieved from <https://www.someaddress.com/full/url/>

Source from print:

- (Full last name, first initial of first name). (Date of publication). Title of source. Title of container (larger whole that the source is in, i.e. a chapter in a book), volume number, page numbers.

### Examples

If retrieving from a webpage:

- Berndt, T. J. (2002). *Friendship quality and social development*. Retrieved from [insert link](#).

If retrieving from a book:

- Berndt, T. J. (2002). Friendship quality and social development. *Current Directions in Psychological Science*, 11, 7-10.

**MLA** outline:

Author (last, first name). Title of source. Title of container (larger whole that the source is in, i.e. a chapter in a book), Other contributors, Version, Number, Publisher, Publication Date, Location (page numbers).

Examples

- Bagchi, Alaknanda. "Conflicting Nationalisms: The Voice of the Subaltern in Mahasweta Devi's *Bashai Tudu*." *Tulsa Studies in Women's Literature*, vol. 15, no. 1, 1996, pp. 41-50.
- Said, Edward W. *Culture and Imperialism*. Knopf, 1994.

**Chicago** outline:

Source from website:

- Lastname, Firstname. "Title of Web Page." Name of Website. Publishing organization, publication or revision date if available. Access date if no other date is available. URL .

Source from print:

- Last name, First name. *Title of Book*. Place of publication: Publisher, Year of publication.

#### Examples

- Davidson, Donald, *Essays on Actions and Events*. Oxford: Clarendon, 2001.  
<https://bibliotecamathom.files.wordpress.com/2012/10/essays-on-actions-and-events.pdf>.
- Kerouac, Jack. *The Dharma Bums*. New York: Viking Press, 1958.



# Versioning

This page provides a record of changes made to this guide. Each set of edits is acknowledged with a 0.01 increase in the version number. The exported files for this toolkit reflect the most recent version.

If you find an error in this text, please fill out the [form](#) at [bit.ly/33cz3Q1](http://bit.ly/33cz3Q1)

| <b>Version</b> | <b>Date</b> | <b>Change Made</b> | <b>Location in text</b> |
|----------------|-------------|--------------------|-------------------------|
| 0.1            | MM/DD/YYYY  |                    |                         |
|                |             |                    |                         |
|                |             |                    |                         |